

**North
Eastern
4x4**

*Land Rover &
4X4 Specialists*



Land Rover
Parts & Accessories

www.northeastern4x4.co.uk



Welcome to the 14th Edition of the Britpart Accessory Catalogue.

This new edition is packed with nearly **300 new parts**. Many of the new parts are for the latest Land Rover models but with plenty of exciting new accessories for the older range of vehicles too, you'll be able to personalise your Land Rover to your exact needs and wants.

Britpart also stock a vast range of repair parts, many of which are featured in this catalogue, to help Land Rover owners across the world to keep their vehicles going both on and off-road.



At Britpart we are always adding new and exciting products to our accessories range, so remember to look at www.britpart.com for all the latest additions. Also worth remembering is that if there is no picture in the catalogue of a product, then visit our website as there are plenty more product pictures online. You can also check out all the news on our Facebook page, so why not visit and 'like us' at www.facebook.com/britpart

01	Exterior Protection	9 - 22
02	Side & Rear Steps	23 - 28
03	Racks & Roll Cages	29 - 38
04	Wheels	39 - 46
05	Lighting	47 - 54
06	Towing	55 - 62
07	Interior Protection	63 - 74
08	Seats & Trim	75 - 84
09	Off-Road	85 - 96
10	Winching	97 - 108
11	Performance	109 - 126
12	Suspension & Axle	127 - 144
13	Diagnostics	145 - 160
14	Repair & Service Parts	
	<i>Repair & Service Parts</i>	161 - 176
	<i>Chassis & Body Components</i>	177 - 184
	<i>Service Kits</i>	185 - 188
	<i>Consumables</i>	189 - 198
	<i>Tools</i>	199 - 204
15	Enhancements	205 - 224
16	Miscellaneous	225 - 238



Our commitment
to you!...

For over 35 years Britpart has been supplying quality parts and accessories for Land Rover users across the world and now we are very proud to announce that all* Britpart parts and accessories will be backed by an industry leading **24 month guarantee.**

With a recent multi-million pound investment in the best Land Rover products and with extensive investment in new staff, equipment and procedures we are convinced this new guarantee will give consumers more confidence in Britpart products. This is backed up with our approval by Lloyd's Register Quality Assurance to BS EN ISO 9001:2008.

This pioneering guarantee will cover over 18,000 parts from our extensive parts catalogue, from springs to clutches and from winches to shock absorbers, confidence in the products we supply is assured. If any part is found to be defective following an inspection by our quality team due to faulty materials or workmanship then that part will be replaced free of charge.

With this significant development in Britpart's philosophy we are now confident that the parts the end users fit to their Land Rovers will deliver time after time, whether the customer is buying a part for a Series 3 or a new Range Rover, they are backed by the same 24 month guarantee.

Look out for the Britpart Guarantee Logo which is a constant reminder to the customer they are fitting the best available parts and accessories to their Land Rover.



*Subject to our standard terms and conditions. Proof of purchase required by the original point of purchase. Excludes Genuine Land Rovers parts, reconditioned gearboxes & engines. This guarantee does not affect your statutory rights.



Now you've seen what we look like from the outside, why not have a look inside?
www.britpart.com/fly

BRITPART

The quality parts for Land Rovers

www.britpart.com



A world of Land Rover parts and accessories
all under one (well several) roofs!

> About Britpart

The Marque

Britpart is the leading independent wholesaler of parts and accessories for Land Rover vehicles, supplying in excess of 1,000 customers worldwide from government agencies to trade outlets.

The name 'Britpart' is synonymous with quality parts for Land Rovers and the company has earned a truly enviable reputation around the globe. For over 35 years, Land Rover enthusiasts the world over have come to identify Britpart as a brand to be trusted.

BRITPART

The quality parts for Land Rovers

The Britpart logo has become a widely recognised and highly respected marque; it embodies excellence in the field, both in quality and commitment to meeting the needs of the customer.

Products

Britpart has always reacted swiftly to the demands of the parts market for all Land Rover vehicles, aiming to provide customers with exactly what they want, when they want it. Parts have long been the mainstay of Britpart's business, with many parts simply being unavailable from other sources; however, accessories are now becoming a major part of the business as owners of Land Rovers, old and new, are customising their vehicles to suit their individual tastes and lifestyles; everything they need is now available from Britpart.

The vast array of Britpart accessories ensures that no two Land Rovers are ever identical!

Land Rover appointed Britpart as an 'Approved European Parts Distributor' for all Land Rover Genuine Parts; this, together with Britpart's own vast range of parts and accessories, along with their extensive inventory of O.E.M. product, has resulted in Britpart becoming the ultimate 'One-Stop-Shop' providing everything its customers could possibly require, all ordered and delivered from one dedicated source.



Quality

Britpart is approved by Lloyd's Register Quality Assurance to BS EN ISO 9001:2008.

Britpart is renowned for quality parts at very competitive prices and takes pride in its excellent customer service, maintaining high stock levels with the aim of fulfilling orders promptly.



Distribution

Parts and accessories for Land Rover vehicles continually flow in and out of the massive state-of-the-art warehouse. Britpart's fleet of vans and trucks all sport the undeniably eye-catching Britpart blue and white livery. Between them they cover the length and breadth of the United Kingdom, including Northern Ireland, delivering directly to Britpart customers on a regular basis, adding to the personal touch that customers have come to associate with Britpart.

Global

When Land Rover finally severed its association with Santana Motor SA it was Britpart who bought up all the existing stock from the factory in Spain and shipped it to their UK headquarters in Shropshire. The shipment included everything from small components to body panels and new engines, along with all the original drawings and tooling. Some of the stock was found to be interchangeable with Land Rover parts and a proportion of the rest is gradually making the journey back home with the assistance of our partner in Spain, Britpart España, Estanfi Automoción.

Britpart's other partners around the globe include: Britpart France, Britpart Belgium, Britpart Brazil, Britpart USA and Britpart Poland.

Britpart is seeking to further expand its comprehensive customer base overseas and is continually looking for well established independent stockists of Land Rover parts to work closely with.

Service

Britpart has an enthusiastic and highly knowledgeable team so that you deal with people who have in-depth knowledge of the business. In addition to major government contracts, we successfully support individual parts retailers, supplying spares for Land Rover models old and new including Series, Defender, Range Rover, Discovery and Freelander.

The lively Sales operation boasts three highly trained teams; one each for Home Sales, European Sales and

Export Sales with technical experts and sales advisors in each, eager to answer the telephone and organise dispatch of goods to their customers within the shortest possible time.

Handmade

The highly skilled team in the Trim Shop make a wide range of seats, seat covers, bases, backs and benches etc for Land Rover vehicles by hand.

Equally skilled is the team in the Lock Shop where a wide range of light engineering work is carried out.

In keeping with the Britpart philosophy, all products leaving the Trim Shop and the Lock Shop are produced to the highest standards and meet with the strictest safety regulations.



Quality Parts

Britpart hold in excess of 26,000 stock items from o-rings and oil seals to engines and exhaust systems. Customers can choose from Britpart quality parts, O.E.M. products and Land Rover Genuine Parts; all delivered promptly at competitive prices.

Everything required for servicing, repairing, restoring or even rebuilding any Land Rover can be supplied by Britpart, thus enabling customers to order all they need on just one order sheet making it easy to keep track of stock and take delivery.

Quality Accessories

Britpart have all the latest accessories you need to customise your Land Rover, whatever the model, to look great on the road and work better off it! From wheels to roof racks, Britpart have everything to ensure that no two Land Rovers need ever look identical.



Exterior Protection

Whether you are going off-road or just want some extra protection on the road for your Land Rover, our wide range of exterior protection is a must have to prevent damage from hidden dangers. We have many forms of exterior protection including chequer plate, A-bars, bumpers, light guards, dash cameras and much more! This section is where you will find protection from front to back and top to bottom for your Land Rover.

- Chequer Plate** 10
- Dirt D-fenders** 16
- Front Protection**
 - A Bars 11
 - Bumpers & bumperettes 12
 - Dash camera 11
- Light Guards**
 - Defender 13
 - Discovery 14
 - Freelander 15
 - Range Rover 15
 - Series 13
- Locking Fuel Cap** 12
- Mirrors**
 - Blind spot mirrors 16
 - Standard mirrors 16
 - Unbreakable mirrors 16
 - XS mirrors 16
- Mudflaps** 17
- Rear Protection**
 - Bumpers & bumperettes 18
 - Parking sensors 18
 - Replacement rear surround cameras 18
 - Reversing camera kits 18
- Security Marking Kit** 22
- Side Protection**
 - Rock & tree sliders 19
 - Rubbing strips 20
 - Wheel arch kits 20
- Tamper Proof Nuts & Bolts** 12
- Underside Protection**
 - Diff guard 21
 - Fuel cooler guard 21
 - Fuel tank, steering/sump & transmission guards 21
 - Swivel housing gaiter kits 22
 - Universal joint silicone sleeves 21
- Wind Deflectors** 22



Chequer Plate

Add some **heavy-duty** protection to your Land Rover.



DA2054



DA2062



DA2066 / DA4049



DA2070



DA4049



DA4049B



DA4049S



DA4073 / DA4072

Defender - Natural aluminium finish	
DA2054	Bumper top plate Single
DA2062	Bumper top plates Pair
DA2060	Mudflap brackets Pair
DA2061	Rear cross member Single
DA2063	Rear floor - 110 CSW Single
DA2064	Rear sides - 110 CSW Pair
DA2067	Rear door - without wiper Single
DA2068	Rear door - wiper - late Single
DA2069	Rear door - wiper - early Single
DA2070	Load bay liner Kit
DA4072	90/Pickup/Hard top/County Station Wagon Sills - 90 Pair
DA4073	Rear wing - 90 Pair
DA4100	Sills - 110 Pair
DA4071	Rear wing - 110 Pair
DA4049	Wing tops Pair
DA4049S	Wing tops - Note - painted silver finish Pair
DA2066	Bonnet protector Single
	Defender - 1983 - 2006
	Curved plate - pre-drilled holes
DA4342	Bonnet protector Kit
	Defender - 2007 onwards

Defender - Satin black finish	
DA4072B	Sills - 90 Pair
DA4073B	Rear wing - 90 Pair
DA4100B	Sills - 110 Pair
DA4071B	Rear wing - 110 Pair
DA4049B	Wing tops Pair
DA3081	Bonnet protector Single
	Defender - 1983 - 2006
	Curved plate - pre-drilled holes
DA4343	Bonnet protector Kit
	Defender - 2007 onwards

Defender - Chequer Plate Kits - Natural aluminium finish	
Kit contains - bonnet, wings, sills & rear corner protection	
DA4296	Defender 90 - up to 2006 Kit
DA4297	Defender 110 - up to 2006 Kit



Many more chequer plate images at www.britpart.com/plate



DA2067



DA2068



DA2069



DA4072B



DA4343



DA2064



DA2060

DA2061

DA2050

Series - Natural aluminium finish	
DA2004	Wing top Pair
DA2050	Rear cross member Single
DA2051	Load bay liner - short wheel base Kit
DA2052	Sills - short wheel base Pair
DA2053	Sills - long wheel base Pair
DA2620 NEW	Deep sills - 2A - short wheel base Pair
DA2054	Bumper plate Single
DA2067	Rear door - without wiper Single
DA4074	Rear wing - short wheel base Pair
Miscellaneous - Natural aluminium finish	
DA2065	Chequer plate steel sheet Single
	1,200 x 2,500mm



DA4073B

Front Protection

A-Bars



- Defender**
VPLPP0060 Black rubber
Defender - no winch Includes spot lamp brackets
- VPLPP0061**
Defender - with winch (genuine winch bumper only)
Black rubber Includes spot lamp brackets
- Discovery**
VPLAP0022 Moulded black rubber
Discovery 4 - up to DA999999 Includes spot lamp brackets
- Freelander**
STC50413 Preformed plastic & foam
Freelander 1 No spot lamp brackets
- VUB503760** Preformed plastic & foam
Freelander 1 - 2004 onwards No spot lamp brackets
- LR003319**
Freelander 2 - with or without parking sensors
Black bumper styling cover No spot lamp brackets
- Range Rover**
VUB501980 Moulded grey plastic
Range Rover Sport - 2005 - 2009 No spot lamp brackets



IMPORTANT NOTICE Please check local legislation before fitting a frontal protection device to a vehicle that is to be used on public roads.

Dash Camera



DA5061
Plug & play camera features 1,080 pixel resolution meaning important details such as vehicle number plates are more visible. An integrated shock sensor works together with a file locking function, to ensure vital recordings are always protected against overwriting. The camera automatically starts recording, when the vehicle ignition is switched on. Older files can be automatically overwritten, so recording never stops. A built-in battery provides backup power, so recordings can always be completed if the power fails. Camera mode allows the unit to operate as a digital camera, so should an incident occur, additional pictures can be taken. Full camera specifications can be found online at www.britpart.com/dash



> Exterior Protection

Bumpers & Bumperettes



- Defender**
- DPB000270** Military front bumper
- RRC6681** Centre pin for bumper
- RRC6682** 'R' Clip for centre pin
- DA5626** Bumper kit - contains all the above part numbers
- DPB000270GALV** Galvanised military front bumper
- DPB104270S** Front bumper with silver finish
- Defender/Series**
- RTC4769** Galvanised front bumperette - single



- Defender Bumper Fitting Kits**
- DA1171K** Easier fitment plates which replace the standard fitted spring clip plates. With stainless steel bolt set.
 - DA1171** Easier fitment plates which replace the standard fitted spring clip plates. Without bolt set.
 - ALQ710020K** Tapping blocks & stainless steel bolt set
 - DA1269** Tapping blocks & bumper bolt kit
 - DA1268** Bumper bolt kit

Locking Fuel Cap

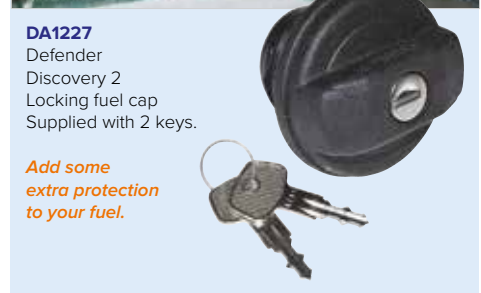

- DA1227** Defender Discovery 2 Locking fuel cap Supplied with 2 keys.
- Add some extra protection to your fuel.*

Tamper Proof Nuts & Bolts



- Ensure your precious accessories remain firmly on your Land Rover by using a set of these tamper proof nuts and bolts. Ideal for securing your winch and front bumper. Each set contains either 4 nuts or bolts and 1 key.
- DA7330** M6 nut set & key
 - DA7331** M8 nut set & key
 - DA7332** M10 nut set & key
 - DA7333** M10 x 110 bolt set & key
 - DA7334** M10 x 35 bolt set & key

Light Guards

Defender



DA4077

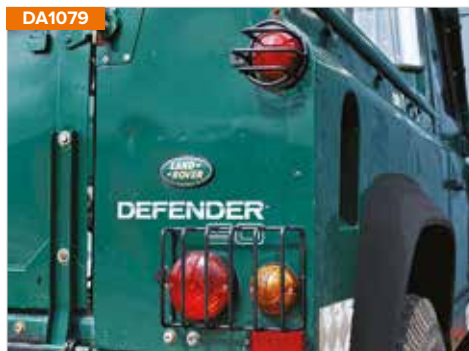

DA1079



DA4400



STC53161

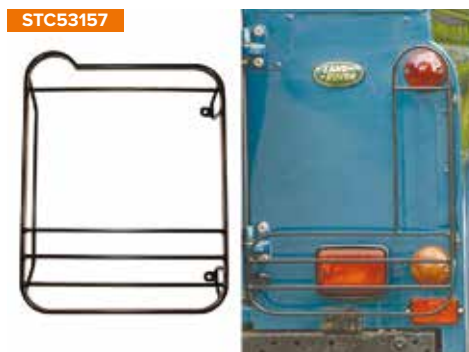

STC53157



STC53158

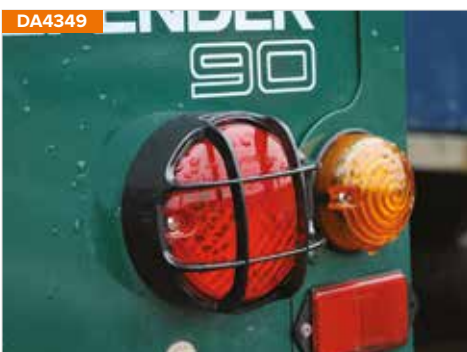

DA4349

DA4077	Defender - all models	Front	Wolf style	Pair
DA1079	Defender - 2003 - 2006 & 2007 onwards	Rear	Wolf style - rectangular & round	Pair
DA4400	Defender - Td5 - 2003 onwards	Front & rear	Wolf style	Kit
RTC8969	Defender - up to 2A622423	Front	Rectangular	Pair
STC53161	Defender - 2A622424 onwards	Front	Rectangular - hinged	Pair
RTC8860AA	Defender - up to 2A	Rear	1 x Square & 1 x L-shape	Pair
STC53157	Defender - 2A onwards	Rear	1 x Square & 1 x L-shape	Pair
DA4133	Defender - Td5	Rear	Rectangular	Single
DA4134	Defender - Td5	Rear	Round	Single
STC53158	Defender - all models	Rear	Square - hinged	Pair
VUB504110	Defender - all models	Rear	Round	Pair
STC8056LR	Defender 110 - Hi-Capacity	Rear	Rectangular	Pair
DA4349	Defender - all models	Rear	Round ABS plastic tail light	Single

They will not rust and you don't need to drill your car to fit these - fitted in seconds. They fit the genuine Land Rover fog and reversing light and the NAS lights. The guard fits over the round rear lights that are roughly 95mm diameter. It is carefully designed complete with the drain hole at the bottom that lines up with the drain hole in the NAS light base.



RTC8969

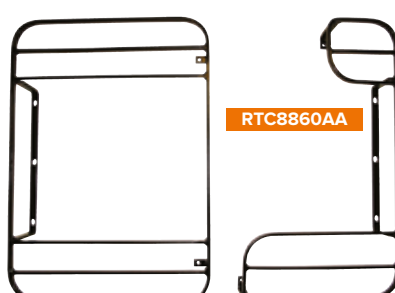

RTC8860AA



STC8056LR

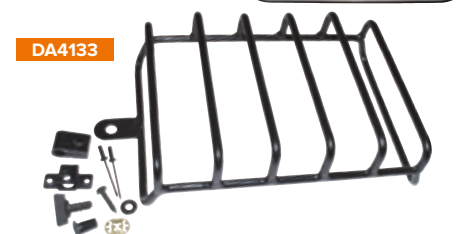

DA4134



DA4134



VUB504110

Series



345985



MRC316



MRC316P

345985	Front	Natural finish	Single	345985P	Front	Plastic coated	Single
MRC316	Rear	Natural finish	Single	MRC316P	Rear	Plastic coated	Single

> Exterior Protection

Discovery



DA4172



RTC9503AA



STC50026



STC50064



STC53181



STC53193



STC50027

Got a great photograph of your Land Rover?
 Why not enter the Britpart calendar competition for your chance to make your Landy a star. Full details can be found here - www.britpart.com/calendar



STC53194



VUB500520



VUB501200



VUB501380



DA1286



VPLAP0008



VPLAP0009

DA4172	Discovery 1 - 300Tdi	Front - acrylic headlight protectors			
RTC9503AA	Discovery 1	Rear wing			
STC50026	Discovery 2 - up to 3A	Front	VUB500520	Discovery 2 - all models	Rear low
STC50064	Discovery 2 - up to 3A	Front - acrylic headlight protectors	VUB501200	Discovery 3 - all models	Front
STC53181	Discovery 2 - 3A onwards	Front	VUB501380	Discovery 3 - all models	Rear
	For fitment with nudge bar (STC53176)		DA1286	Discovery 3 - acrylic headlight protectors	Front
STC53193	Discovery 2 - 3A onwards	Front	VPLAP0008	Discovery 4 - all models	Front
STC50027	Discovery 2 - all models	Rear bumper & rear upper set	VPLAP0009	Discovery 4 - all models	Rear
STC53194	Discovery 2 - all models	Rear wing			

Note - All Discovery headlight guards supplied as pairs.

Range Rover



STC8027LR

Range Rover Classic

Rear - hinged

DA4173

Range Rover P38 - up to 1999

Front

Acrylic headlamp protectors

VUB501930

Range Rover Sport - 2005 - 2009

Front

VUB501920

Range Rover Sport - 2005 - 2009

Rear

VPLSP0010

Range Rover Sport - 2010 - 2013

Front

VPLTP0064

Range Rover Sport - 2010 - 2013

Rear

DA1290

Acrylic headlight protectors

Range Rover Sport - 2005 - 2013

Front

VUB001070LR

Range Rover L322 - up to 6A

Front

Note - Front lamp guards not compatible with wraparound protection bar

VUB001080LR

Range Rover L322

Rear

DA1288

Acrylic headlight protectors

Range Rover L322 - 2002 - 2010

Front

DA1289

Acrylic headlight protectors

Range Rover Evoque

Front

Note - All Range Rover headlight guards supplied as pairs

Protect your **valuable headlights** from accidental damage either on or off-road!



Freelander

VUB501390

Freelander 1 - 2004 onwards

Front Pair

LR002408

Freelander 2

Front Pair

LR003685

Freelander 2

Rear Pair

DA1287

Freelander 2

Front Pair

Acrylic headlight protectors



facebook.com/britpart

Mirrors

XS Mirrors



DA6892 NEW XS Wing mirror Black Single
XS Mirrors exclude mirror arms.



DA6893 NEW XS Wing mirror Silver Single



facebook.com/britpart

Unbreakable Mirrors

	Head Dimensions		Arm Length	
DA4404	Flat mirror	204 x 140mm (8 x 5½")	No arm	Flat with fixing kit
DA4405	Flat mirror	204 x 140mm (8 x 5½")	170mm	Flat with fixing kit and short arm
DA4406	Flat mirror	204 x 140mm (8 x 5½")	290mm	Flat with fixing kit and long arm
DA4407	Convex mirror	204 x 140mm (8 x 5½")	No arm	Convex with fixing kit
DA4408	Convex mirror	204 x 140mm (8 x 5½")	170mm	Convex with fixing kit and short arm
DA4409	Convex mirror	204 x 140mm (8 x 5½")	290mm	Convex with fixing kit and long arm

Good visibility is imperative on today's highways and byways so these new high impact resistant mirror heads are an essential item.

- > Optical quality polycarbonate lens - will not shatter like glass or discolour in sunlight.
- > Strong, flexible polypropylene casing - will absorb hard blows without breaking.
- > Universal - can be fitted to either left or right of vehicle.
- > Lightweight - puts less strain on body fixings.
- > Hard lacquer coating on lens - will repel condensation and surface water.
- > Excellent reflectivity - superb daylight and night time vision.

Dirt D-fenders



Dirt D-Fenders are a great solution to the annoying problem of mud which splashes through the gap which exists between the bottom of the wheel arch and the mudflap of your Defender. They are an especially useful addition if you are using wider tyres. The Dirt D-Fenders attach with rivets into the underside of the sill and wheel arch flare. Supplied in pairs with the fitting kit.

Blind Spot Mirrors

DA6550R Right hand side
DA6550L Left hand side

Working closely with one of Europe's leading mirror manufacturers, MUD has created a retrofit mirror for the Defender that incorporates a wide angle convex mirror to eliminate potentially dangerous blind spots. The Blind Spot Mirror function offers a huge improvement in road safety, making lane changing manoeuvres safer whether you're in slow or fast moving traffic.



The surface area of the XL Defender Mirror Head measures 245mm x 140mm compared with the standard mirror glass area of 198mm x 124mm. The mirror area of the MUD Blind Spot mirror is 173mm x 127mm and the convex section is 52mm x 127mm. The convex section is fixed and not adjustable.

The MUD Blind Spot mirror is a straight swap for the original Defender door mirrors, using the same fixing method as the factory mirrors and even retain the same styling as the original Defender door mirror to ensure an OE factory appearance. The MUD Blind Spot Mirror is housed within a larger mirror head that in addition to providing a larger reflective surface area than the standard Defender mirror glass, features the convex wide angle mirror glass. The mirror insert can be flipped through 180 degrees within the mirror head so the wide-angle can be positioned at the top or the bottom of the mirror. The MUD Blind Spot Mirror has been fully homologated, E-marked and carries full EU Type Approval.

Standard Mirrors



MTC5217

Series			
DA2128	Mirror arm	7"	Standard
DA2130	Mirror head	7 x 5"	Standard
DA2301	Mirror glass	7 x 5"	Standard
Defender			
MTC5083	Mirror arm	7"	Standard
RRC8443	Mirror arm	11½"	Large
MTC5084	Mirror head	5 x 8"	Standard
DA4034	Mirror head	6 x 10½"	Large
MTC5217	Mirror assembly		Standard



DA4598

Heated mirror kit
See vehicle enhancement section for more details.



Keep the side of your Defender cleaner!



DA1193	Defender - 90/110/130	Rear of front wheel
DA1198	Defender - 90/110	Front of rear wheel
DA1197	Defender - 90	Rear of rear wheel
DA1194	Defender - 110	Rear of rear wheel

Note - DA1193 & DA1198 will not fit Defenders with rock/tree sliders fitted.



DA1194

Mudflaps

Reduce those muddy splashes from over your Land Rover.

Defender - 1987 onwards

Front Mudflaps

CAS500180PMA	90/110/130 - up to AA792970
LR055323	90/110/130 - from AA792971
CAS500190PMA	90/110/130 - up to AA792970
LR055333	90/110/130 - from AA792971
RTC4685	90/110/130 - flaps only
RTC9479	90/110/130 - with brackets

Rear Mudflaps

CAT500410PMA	90 - up to AA792970 - black Britpart logo
LR055332	90 - from AA792971 - black Britpart logo
CAT500540PMA	90 - up to AA792970 with exhaust cut-out - black Britpart logo
LR055340	90 - from AA792971 with exhaust cut-out - black Britpart logo
CAT500450PMA	90 - no exhaust cut-out - black Britpart logo
DA4531	90 - with exhaust cut-out - yellow Britpart logo
DA4532	90 - no exhaust cut-out - yellow Britpart logo
DA4533	90 - Wide mudflaps - universal fitment - no exhaust cut-out - yellow Britpart logo
MXC6412	90 - from FA414687 up to WA159806
MXC6413	90 - from FA414687 up to WA159806
MUC3990	90 - hard & soft top - from AA232011 up to FA414686
MUC2344	90 - from 3A650368 up to 5A690309
DA4534	110/130 Crew cab - yellow Britpart logo
DA4536	110/130 Crew cab - Wide mudflaps - yellow Britpart logo
BTR277	110/130 - universal - flap only - from FA414616
CAT500340PMA	110/130 - up to AA792970 - black Britpart logo
LR055330	110/130 - from AA792971 - black Britpart logo
CAT500350PMA	110/130 - up to AA792970 - black Britpart logo
LR055334	110/130 - from AA792971 - black Britpart logo
CAT500360PMA	110/130 HCPU - up to AA792970 - black Britpart logo
LR055331	110/130 HCPU - from AA792971 - black Britpart logo
CAT500370PMA	110/130 HCPU - up to AA792970
LR055339	110/130 HCPU - from AA792971
DA4535	110/130 HCPU - yellow Britpart logo

DA4531



DA1188
Galvanised front mudflap brackets - pair
Equivalent to MTC3000 & MTC3001
Defender 90/110

DA1187
Galvanised rear mudflap brackets - pair
Equivalent to MUC3986 & MUC3987
Defender 90

Britpart now offer a wider than standard mudflap, ideal for Defenders fitted with wheel spacers.

CAT500540PMA



Discovery

Discovery 1

RTC6820	Front	Pair
RTC6821	Rear	Pair

Discovery 2

CAS100900	Front & rear	RH
CAS100910	Front & rear	LH

Replacement mudflaps for side step DA8534

STC50221 NEW		RH
STC50222 NEW		LH

Discovery 3

CAS500010PCL	Front	Pair
CAT500010PCL	Rear - unpainted bumper	Pair
VPLAP0017	Rear - partially painted bumper	Pair

Discovery 4

CAS500010PCL	Front	Pair
CAT500010PCL	Rear - unpainted bumper	Pair
VPLAP0017	Rear - partially painted bumper	Pair

All-New Discovery

VPLRP0283LR NEW	Front	Pair
VPLRP0282LR NEW	Rear	Pair

Discovery Sport

VPLCP0203	Front	Pair
VPLCP0204	Rear	Pair

VPLCP0205LR	7-seat without spare wheel & 5-seat	Pair
	7-seat with spare wheel	Pair

Freelander

Freelander 1

STC7978AB	Front	Up to 1A999999 - Hatton Grey	Pair
STC53075AA	Front	From 2A000001 - Black	Pair
STC53076AA	Rear	From 2A000001 up to 3A999999 - Black	Pair
CAT500060PMA	Rear	From 4A000001 - Black	Pair

Freelander 2

LR003324	Front		Pair
LR003322	Rear		Pair

Range Rover

Range Rover Classic

RTC9562	Front	1986 - 1994	Pair
MXC5587	Front - flap only	1986 - 1994	Single
MXC5587	Rear - flap only	1986 - 1994	Single

Range Rover P38

CAS100920	Front	From XA428522	RH
CAS100930	Front	From XA428522	LH
STC8535	Front		Pair
STC8536	Rear	Single exhaust	Pair
STC7703	Rear	Twin exhaust	Pair
CAT101160	Rear	From XA428522	RH
CAT101170	Rear	From XA428522	LH

Range Rover Sport - 2005 - 2009

CAS500070PCL	Front		Pair
CAT500120PCL	Rear	Less sport bumper protection	Pair

Range Rover Sport - 2010 - 2013

CAS500070PCL	Front		Pair
VPLSP0016	Rear		Pair

Range Rover Sport - 2014 onwards - not SVR model

VPLWP0167	Front	Compatible with electric deployable step	Pair
VPLWP0165	Front	Not compatible with electric deployable step	Pair
VPLWP0166	Rear		Pair

Range Rover L322 - 2002 - 2009

CAS000150PMA	Front	Up to 5A999999	Pair
VUB001320	Front	Up to 5A999999	RH
VUB001330	Front	Up to 5A999999	LH
CAS500060PMA	Front	From 6A198416	Pair
VUB503940	Front	From 6A198416 - for side step	Pair
CAT000180PMA	Rear	Up to 5A999999	Pair
CAT500070PMA	Rear	From 6A198416	Pair

Range Rover L322 - 2010 - 2012

CAS500060PMA	Front	From AA000001	Pair
CAT500070PMA	Rear	From AA000001	Pair

Range Rover L405 - 2013 onwards

VPLGP0111	Front	Compatible with electric deployable step	Pair
VPLGP0109	Front	Not compatible with electric deployable step	Pair
VPLGP0110	Rear		Pair

Range Rover Evoque

VPLVP0065	Front	Pure & Prestige	Pair
VPLVP0069	Rear	Pure & Prestige	Pair
VPLVP0066	Front	Dynamic	Pair
VPLVP0070	Rear	Dynamic - excluding parallel parking sensors	Pair

CAS500010PCL



CAT500010PCL



Note - RH - Right hand side / LH - Left hand side

More mudflap images at www.britpart.com/mudflaps

CAS500070PCL



CAT500120PCL



Rear Protection



DA5647
Discovery 1 - 300Tdi - will also fit 200Tdi. See note below.
> One piece rear heavy-duty bumper manufactured from 5mm steel with incorporated steel end caps and 2 recovery points, finished in black.
> Provision for NATO/recovery point in centre of bumper.
> Fixed to standard mounting points and for added strength, extra fixings in centre where tow bar mounts.
Note - Tow bar and rear lights not included.
Will fit 200Tdi if 300Tdi lamps are used.
Right lamp - AMR6510; left lamp - AMR6509

Bumpers & Bumperettes



DA5646
Discovery 2
> One piece rear heavy-duty bumper manufactured from 4mm steel with incorporated steel end caps, finished in black.
> 2 Recovery points and 2 Hi-Lift jacking points included.
> Fixed to standard mounting points and for added strength, extra fixings in centre where tow bar mounts.
Note - Tow bar and rear lights not included.
Up to 3A771194 - right lamp - XFB101480; left lamp - XFB101490. From 3A771195 - right lamp - XFB000720; left lamp - XFB000730

Added protection...

DA2071	Defender/Series	Black
Rear bumperettes	Pair	
RRC2970	Defender/Series	Black
Rear bumperette	Single - RHS	
RRC2971	Defender/Series	Black
Rear bumperette	Single - LHS	
ISG000040	Defender Wolf	Black
Rear bumperette	Single - RHS	
ISG000050	Defender Wolf	Black
Rear bumperette	Single - LHS	



Replacement Rear Surround Cameras

LR031790
Range Rover Sport - 2010 - 2013
LR031812
Range Rover L322 - 2010 - 2012
LR052028
Discovery 4 - Front bumper/tailgate/side view mirrors
Range Rover Evoque - Front bumper/side view mirrors
Range Rover Sport - 2014 onwards - Front bumper/side view mirrors
Range Rover L405 - Front bumper/side view mirrors



Reversing Camera Kits

DA6611
Rear facing camera kit - includes monitor
Typically mounted under the number plate on a Defender and on the rear end door handle on a Freelander, Discovery & Range Rover Classic.
DA6610
Front facing camera kit - no monitor
An additional camera to add to DA6611 kit.
DA6613
Rear facing camera kit - no monitor
An additional camera to use on a trailer which can be added to DA6611 kit. Cable length is 20 metres.

Seeing exactly what is behind a Land Rover is not easy using conventional mirrors. This kit is a practical driver assistance device with the primary objective of helping the driver to see things that they may not otherwise see when reversing. The kit is engineered to the highest standards with a focus on making it simple to install, robust and discreet. One connection is made to the reversing light circuit and ground to the bodywork. A single cable is then fed through the vehicle from the back to the front to connect the camera to the 3½" slim line monitor. No other work is involved. When the vehicle is put into reverse gear, a sharp and vivid image is instantly displayed on the screen. The camera is the only external part and much like the vehicle it will be installed on it can be submerged in water, it can be blasted by a jet wash, sprayed with mud. Effectively there is very little that can be done to damage the camera, short of hitting it with a solid object. But even then it can withstand some abuse.

- > Waterproof rear view or reverse camera.
- > Small, discreet, MicroBlock™ colour camera.
- > Slimline 3½" LCD monitor.
- > Typically installed above number plate to include the rear bumper in the field of view.
- > Outstanding image quality both day & night.
- > Panoramic view.
- > Instant image on.
- > Single cable installation technology - easy to install.
- > IP68 rated so 100% water and dust proof.



Outstanding image quality

Parking Sensors



Reduce the risk of collision during reversing.

DA4511
These bumper* mounted sensors will detect the distance between your vehicle and any rear obstruction and warn the driver to any potential obstructions. An advanced parking solution for obstacle detection at the rear of your vehicle. Reduce the risk of collision during reversing and reverse parking manoeuvres with this kit.

As the reverse gear is engaged, a sound indicates that the reverse sensors are activated. Any obstacle at the rear of the vehicle is then detected and signalled to the driver through a progressive sound whose frequency increases when moving closer to the obstacle.

Enhance your safety through obstacle detection, even when objects are out of the driver's field of vision. Improve comfort through easy parking manoeuvres. Suitable for 12v cars, SUVs and light commercial vehicles.

- Kit contents include -
- 4 x Bumper fit sensors
 - 1 x Warning buzzer
 - 1 x Control unit
 - 1 x Wiring harness
 - 1 x Cutting tool
 - 1 x Fitting accessories
 - 1 x Installation instructions

Add an extra set of 'eyes' when reversing...



*Note - Not suitable for vehicles with metal bumpers.

Side Protection

Rock & Tree Sliders

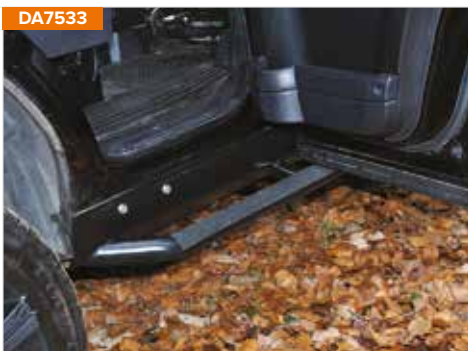

DA7533



DA7534



DA7534B

DA7533

Rock slider/side steps - pair
Discovery 3 & Discovery 4
The best of both worlds with these fitted to your Discovery!

Rock slider - an essential purchase for any off road use. They prevent damage to the underside sill of the vehicle and allow for safe passage over rocky and rough terrain.

Side steps - users often fit side steps to enable easy access to and from the car - this is a problem when going off road as they bend, break and cause snagging. These are heavy-duty side steps made from 5mm steel plate with 50mm tube backed up by an additional 2 x 40mm tube supports. The joints are TiG welded for a smooth OEM finish.

Great protection for the side of your Land Rover and they replace the sill of your vehicle. These rock & tree sliders are a fully welded 3mm steel construction with heavy-duty chassis mounted brackets and zinc primed with a smart black powder coated finish.

Rock Sliders

- DA1307 Defender 90 - 1983 onwards
- DA1308 Defender 110 - 1984 onwards
- DA1311 Discovery 1 - 3-door
- DA1312 Discovery 1 - 5-door
- DA1313 Discovery 2

Rock & Tree Sliders

- DA1307T Defender 90
- DA1308T Defender 110
- DA1311T Discovery 1 - 3-door
- DA1312T Discovery 1 - 5-door
- DA1313T Discovery 2



Photo courtesy of Jon Wilson

DA7534

Aluminium finish

Discovery 3 & Discovery 4

These rock sliders (sill protectors) are manufactured from 6mm 5083 aluminium and come completely machined and drilled ready to fit. An essential purchase for any off-road use as they prevent damage to the underside sill of the vehicle and allow for safe passage over rocky and rough terrain. Attaches to your vehicle using 11 mounting points on the side and underneath and when the car doors are closed they are almost unseen, but you have the piece of mind that your car sills are safe from damage. These units require no additional drilling just unscrewing and unclipping of the plastic OEM parts. For more information & images of these rock sliders visit www.britpart.com/rock

DA7534B

Black finish

For more side protection - see side & rear step section

*Direct fit!
No Cutting!*



DA1307

DA1307T

DA1308

DA1308T

DA1311

DA1311T

DA1312

DA1312T

DA1313

DA1313T

Rubbing Strips

DGJ500020PCL



DGJ500020PCL

Range Rover Sport - 2005 - 2013

Protect your bodywork from dents and scrapes with a smart set of 4 solid and durable bodyside moulding strips.



Photo courtesy of Kristjan Kristjansson

Bowler 'Spectre' Wheel Arches

DA1348 NEW

Defender 110

Produced in the UK and inspired by the JLR Special Vehicles produced Defenders for the film Spectre, these arches are identical in terms of size and shape, are finished in gloss black and come complete with fitting templates.



DA1348



Wheel Arch Kits

DA1059

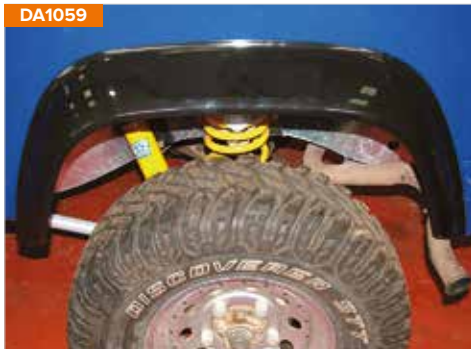

DA1140



Standard Wheel Arch Kits

Replace any faded or damaged wheel arches with this OEM replacement wheel arch kit

DA1059 Defender - all models 4 eyebrows and rivets

DA1140 Discovery 2 Front/Rear & RHS/LHS

DA2364



DA2365



Off-Road Wheel Arch Kits

2.5" wheel arch kits. Wings need cutting for fitting.

DA2364 Discovery 1/Range Rover Classic 3-door

DA2365 Discovery 1/Range Rover Classic 5-door

2" wider than standard enabling tyres up to 14" wide and/or wheel spacers to be fitted while being legal for MOT testing. Made from an unbreakable plastic - ideal for extreme off-road use.

DA2366 Defender 90/110 - 1984 onwards

These two Discovery 2 wheel arches enable larger tyres to be fitted while still being legal as these arches cover the tyres when wider tyres are fitted. The 50mm ones are required for large off set wheels while the 75mm arches will cover the tyres when wheel spacers are used. They are virtually indestructible and all fixings are supplied with the kit. Up to 35" diameter tyres are okay with a 2" lift and these arches as just over 40mm is cut out of the wings when fitting them.

DA1960 Discovery 2 50mm

DA1961 Discovery 2 75mm

DA2366



DA1960



Underside Protection

Fuel Tank, Steering/Sump & Transmission Guards



Great protection from hidden dangers.



Sump guards

These guards from Britpart are manufactured from high-quality, hard-wearing and corrosion resistant materials to counteract any unforeseen obstacles your Land Rover may encounter whilst off-roading. All fixings are supplied and the guards fit into the vehicle's pre-existing holes. Each guard has holes at the front to allow for water drainage and also to help with ventilation for the cooling system.

DA5507	Defender - 1985 -2006 & 2007 onwards	RHD
Aluminium	Main plate - 8mm thick; brackets - 8mm thick	
DA5507LHD	Defender - 1985 -2006 & 2007 onwards	LHD
Aluminium	Main plate - 8mm thick; brackets - 8mm thick	
DA5508	Discovery 1/Range Rover Classic	RHD & LHD
Aluminium	Main plate - 8mm thick; brackets - 8mm thick	
DA2249	Discovery 2	RHD & LHD
Powered coated steel	Main plate - 5mm thick; brackets - 5mm thick	

Note - For use with Discovery 2 winch bumper DA5645

An essential purchase for any off road use as they prevent damage to the underside of the engine and the intercooler at the front of the vehicle. Manufactured from 8mm 5083 aluminium with a smart silver or black finish and supplied completely machined and drilled ready to bolt directly to the 4 pre-drilled holes in the chassis with supplied galvanised fixings. The guard requires no additional drilling just unscrewing and unclipping of the plastic OEM parts. Fitting should take 5 minutes.

Discovery 3	DA7530	Silver finish	DA7530B	Black finish
Discovery 4	DA7535	Silver finish	DA7535B	Black finish



Fuel Cooler Guard

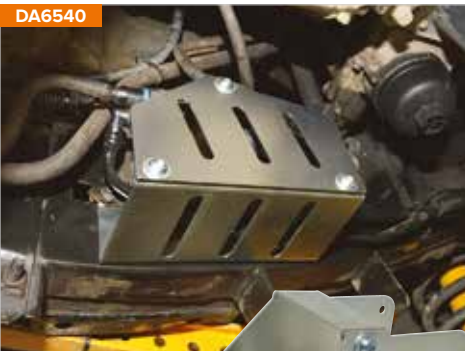

DA6540
Defender - Tdci
Protect the Defender's vulnerable fuel cooler with this easy to fit electro-plated guard.



Diff Guard



DA2250B Defender/Discovery 1/Range Rover Classic
Give your vehicle some extra protection with a diff guard. This guard is simple to fit (no drilling) and has the added advantage of having the fill plug accessible at all times. With electroplate finish.

Universal Joint Silicone Sleeves



Suitable for Series, Defender, Discovery 1, Discovery 2 & Range Rover Classic. By adding one of these silicone sleeves you will reduce debris from building up in the universal joint which, in time, will increase the life span of the joint.
DA4810
Rear UJ silicone sleeve for 63mm diameter propshafts
DA4811
Rear UJ silicone sleeve for 51mm diameter propshafts

Swivel Housing Gaiter Kits



Permanent Protection!

- > Bond in place under existing flange.
- > Completely seals against dust, water and grit.
- > Moulded in high performance neoprene rubber.
- > No special tools required.
- > Proven tongue and groove for easy assembly.
- > Two year guarantee.
- > Kit includes two gaiters, metal straps, bonding agent, gloves and full instructions.

DA3056

Series/Lightweight

DA3057

Defender/Discovery 1/Range Rover Classic

DA3057GLUE

Additional bonding agent for DA3056 & DA3057
For easier fitting of gaiter without dismantling the axle assembly.

Security Marking Kit



DA8533

Help prevent your Land Rover from being stolen with this easy to use security marking kit. Full details of the kit can be found in Security in the miscellaneous section or at www.britpart.com/security

Wind Deflectors



No drilling required for fitting.

The Britpart wind deflectors will reduce buffeting and wind noise when driving with the window open. Custom designed for each vehicle and easily attached - no drilling required for fitting!

DA6078	Defender/Series	Front	2 piece kit	DA6070	Range Rover Classic	Front & rear	4 piece kit
DA6070	Discovery 1	Front & rear	4 piece kit	DA6121	Range Rover P38	Front & rear	4 piece kit
DA6071	Discovery 2	Front & rear	4 piece kit	DA6076	Range Rover Sport - 2005 - 2013	Front & rear	4 piece kit
DA6072	Discovery 3/Discovery 4	Front & rear	4 piece kit	DA6107	Range Rover Sport - 2014 onwards	Front & rear	4 piece kit
DA6079	Discovery Sport	Front & rear	4 piece kit	DA6075	Range Rover L322	Front & rear	4 piece kit
DA6073	Freelander 1 - 2 door	Front	2 piece kit	DA6108	Range Rover L405	Front & rear	4 piece kit
DA6077	Freelander 1	Front & rear	4 piece kit	DA6093	Range Rover Evoque - 3 door	Front	2 piece kit
DA6074	Freelander 2	Front & rear	4 piece kit	DA6094	Range Rover Evoque - 5 door	Front & rear	4 piece kit

Side & Rear Steps

Whether you need to replace a broken step, or want to smarten up your Land Rover with new steps, our selection will provide assistance when getting in and out of your vehicle. We have both rear and side steps in a variety of styles and patterns to allow you to find the one that best suits your Land Rover!

Defender	
Rear steps.....	25
Side protectors.....	24
Side steps.....	25
Discovery	26
Freelander	25
Range Rover	27



> Side & Rear Steps

Defender

Side Protectors



DA7012	Defender 90	Black with chequer plate top	Pair
DA7012SS	Defender 90	Stainless steel	Pair
DA7011	Defender 110	Black with chequer plate top	Pair
DA7011SS	Defender 110	Stainless steel	Pair



For rock sliders - see exterior protection section

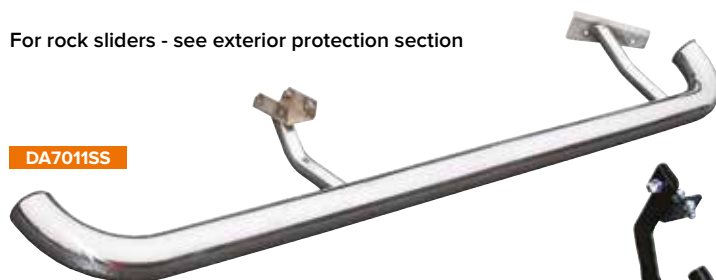

Side Steps



LR008379	Defender 90 – 2003 ->/Defender 110 – 2-dr pick-up – 2003 ->	Fire & Ice style - black with rubber and anodised aluminium top	Pair
LR008375	Defender 110 – 2003 -> - not 2-dr pick-up		
LR008379B	Defender 90 – 2003 ->/Defender 110 – 2-dr pick-up – 2003 ->	Fire & Ice style - black with rubber and anodised black aluminium top	Pair
LR008375B	Defender 110 – 2003 -> - not 2-dr pick-up		
LR008379SS	Defender 90 – 2003 ->/Defender 110 – 2-dr pick-up – 2003 ->	Fire & Ice style - stainless steel with rubber and anodised aluminium top	Pair
LR029294KIT	Defender 110 – 2003 -> - not 2-dr pick-up		
LR029295/7KIT	Defender 90 – 2003 ->/Defender 110 – 2-dr Pick-up – 2003 ->	Black with rubber and anodised aluminium chequer plate top	Pair
LR029294KIT	Defender 110 – 2003 -> - not 2-dr pick-up		

DA4101	Defender 90	Black with rubber top	Pair
DA4060	Defender 110	Black with rubber top	Pair
VPLDP0068	Defender 90	Twin tube - black with rubber top	Pair
VPLDP0067	Defender 110	Twin tube - black with rubber top	Pair

Defender - continued

Side Steps



Photo courtesy of Carol Dabill

STC7631MT



STC7631



DA4814



STC7631	All models	Folding side step with rubber top	Single
STC7631MT	All models	Folding side step with rubber tyre tread top	Single
DA4814		Replacement rubber top with tyre tread pattern for STC7631	Single

Rear Steps

- STC50269AA** Defender 90 - XA onwards
Rear step - includes regulation tow bracket
- STC50301** Defender 110 - XA onwards
Rear step - includes regulation tow bracket
- DA4070** All models
Rear tow ball step - double with zinc plated finish
Will also fit any vehicle with a drop plate tow hitch.
- DA4070B** All models
Rear tow ball step - double with black
Will also fit any vehicle with a drop plate tow hitch.
- STC7632** All models
Folding rear door step with rubber top
- STC7632MT** All models
Folding rear door step with rubber tyre tread top
- DA4818** Replacement rubber top with tyre tread pattern for STC7632 Single

STC7632MT



DA4818



STC7632



DA4070



DA4070B



STC50269AA



Photo courtesy of Pascal Perrier

Freelander

- LR002773** Freelander 2 Side steps Pair
With thermo plastic elastomer side step top and a brushed aluminium side trim

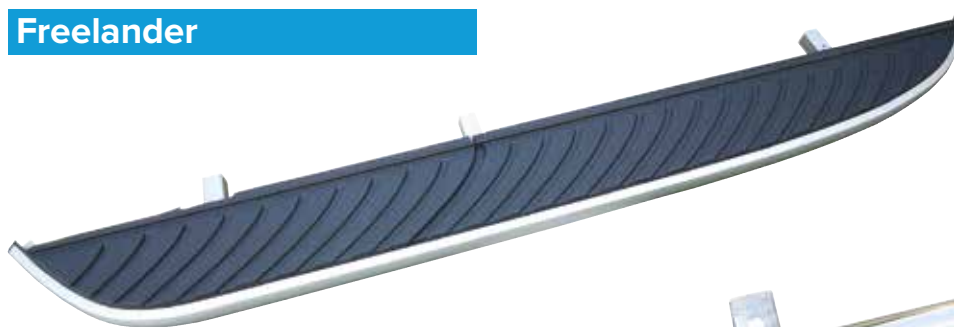

- LR003318** Freelander 2 Side protection tubes Pair
Stainless steel



Discovery



Discovery 1	Side steps	Chevron tread	Pair
STC8130AB			
Discovery 2	Side steps - including mudflaps	Chevron tread	Pair
DA8534			
Replacement mudflaps - STC50221 NEW - RHS & STC50222 NEW - LHS			
STC50032	Side steps - including mudflaps	Stainless steel	Pair
Discovery 3 / Discovery 4			
VTD500010	Black steel side protection tubes		Pair
VTD500020	Stainless steel side protection tubes		Pair
VTK500010	Side steps - with polypropylene side step top and a brushed aluminium side trim		Pair
VPLAP0035			
All-New Discovery			
VPLRP0269LR NEW	Side steps		Pair
VPLRP0270LR NEW	Side tubes		Pair
Discovery Sport			
VPLCP0210LR	Side steps		Pair
VPLCP0209LR	Side tubes		Pair

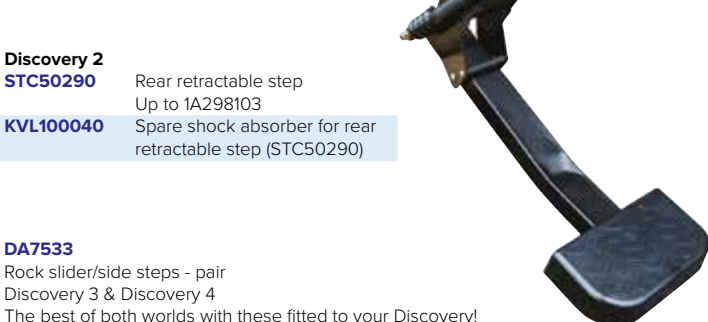

Discovery 2	Rear retractable step	
STC50290	Up to 1A298103	
KVL100040	Spare shock absorber for rear retractable step (STC50290)	



DA7533
Rock slider/side steps - pair
Discovery 3 & Discovery 4

The best of both worlds with these fitted to your Discovery!

Rock slider - an essential purchase for any off road use. They prevent damage to the underside sill of the vehicle and allow for safe passage over rocky and rough terrain.

Side step - users often fit side steps to enable easy access to and from the car - this is a problem when going off road as they bend, break and cause snagging. These are heavy-duty side steps made from 5mm steel plate with 50mm tube backed up by an additional 2 x 40mm tube supports. The joints are TiG welded for a smooth OEM finish. The other benefit of this rock slider/side step combo is that the outer 'bar' pushes away small trees and scrub from the bodywork of the vehicle. They can also be used to 'slide' around thick trees when grip is minimal. These units require no additional drilling just unscrewing and unclipping of the plastic OEM parts. Fitting should take 15 minutes each side. Grip tape supplied loose for optional fitment.

Range Rover



STC8505AA



VUB001230



VUB002510



VUB503660



VTK500020 / VPLSP0040



VPLVP0184

Range Rover Classic

STC8130AB Side steps - black rubber Pair

Range Rover P38

STC8505AA Side steps - includes mudflaps Pair

Range Rover Sport - 2005 - 2013

VTK500020 / VPLSP0040 Side steps Pair

With thermo plastic elastomer side step top and a brushed aluminium side trim

Range Rover Sport - 2014 onwards

VPLGP0226 Side steps Pair

VPLGP0239LR Powered side step - step Left hand side

VPLGP0248LR Powered side step - fixings Left hand side

VPLGP0238LR Powered side step - step Right hand side

VPLGP0249LR Powered side step - fixings Right hand side

Range Rover L322

VUB001230 Stainless steel side protection tubes Pair

VUB002510 Black steel side protection tubes Pair

Note - Can be fitted with or without front mudflaps

VUB503660 Side steps Pair

Including front mudflaps with EPDM (synthetic rubber) top and hard plastic trimming

VUB001300 Side step replacement insert moulding for VUB503660 Right hand side

VUB001310 Side step replacement insert moulding for VUB503660 Left hand side

Range Rover L405

VPLGP0100 Stainless steel side protection tubes Pair

VPLGP0226 Side steps Pair

VPLGP0239LR Powered side step - step Left hand side

VPLGP0248LR Powered side step - fixings Left hand side

VPLGP0238LR Powered side step - step Right hand side

VPLGP0249LR Powered side step - fixings Right hand side

Range Rover Evoque

VPLVP0071 Side steps Pair

VPLVP0184 Stainless steel side protection tubes Pair

STC8130AB



VPLGP0226



VPLGP0100



VPLWP0191

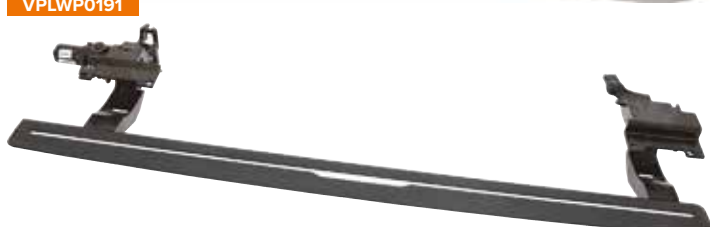

Photo courtesy of Paul Wade

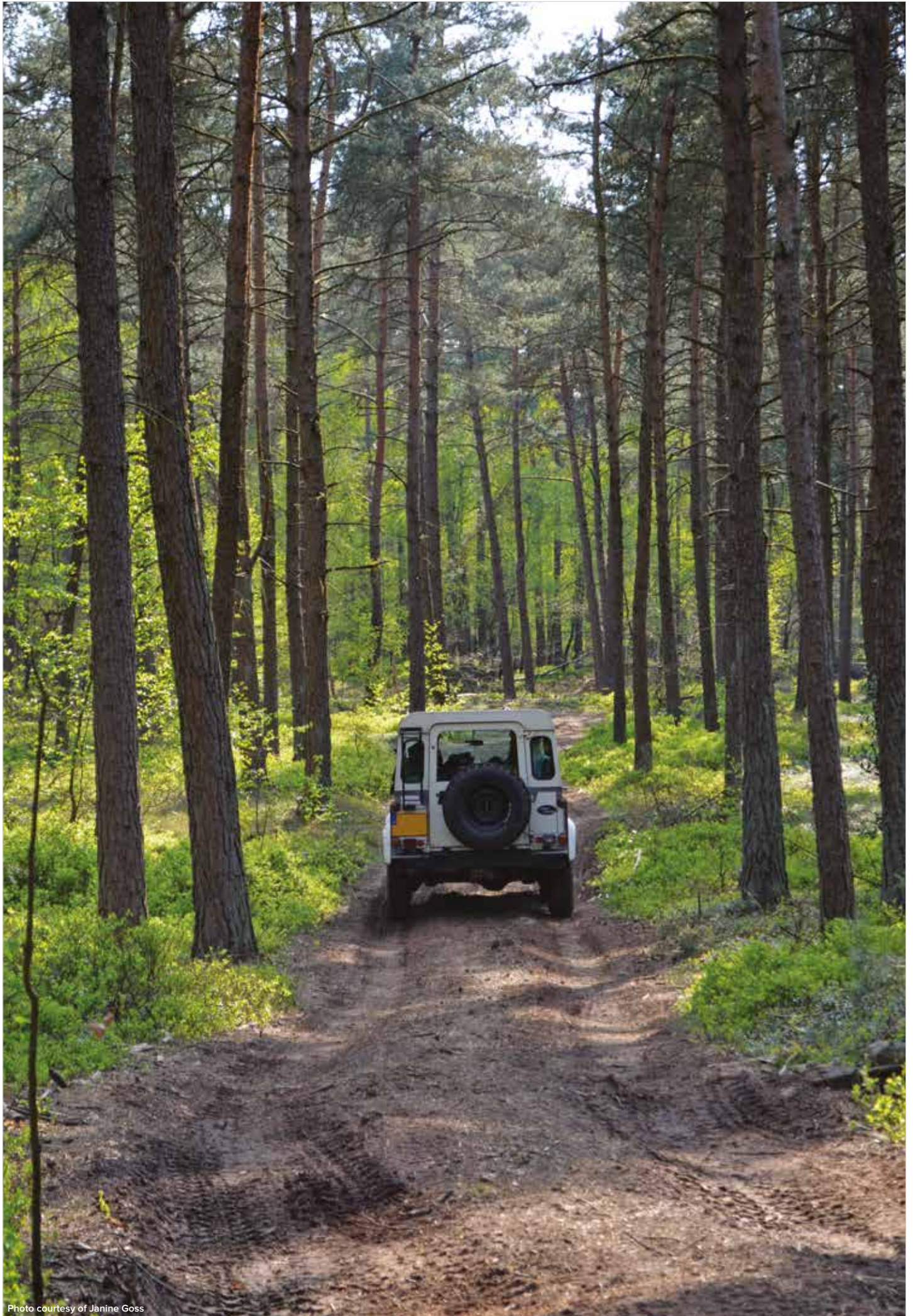

Photo courtesy of Janine Goss

Racks & Roll Cages

Do you need some extra space for transporting items?

Our wide range of roof racks, bike racks and luggage boxes are extremely strong and versatile allowing you to expand your load capacity. Roll cages offer some extra protection and piece of mind whilst off-roading.

Bike Racks	30
Ladders	30
Load Securing System	37
Roof Racks	
Britpart Expedition	33
Front Runner	31
Galvanised roof rack kits	31
Land Rover	32
Mont Blanc	32
Safety Devices	34 - 35
Thule	31
Roll Cages	36

> Racks & Roll Cages

Bike Racks



The Westfalia Cycle Carrier is an innovative and flexible system that allows you to transport your bikes easily, helping make your journey more relaxing and enjoyable. The Cycle Carrier is a highly versatile, foldable, towbar mounted, carrier system. Plenty more information and images at www.britpart.com/westfalia

DA5022
Westfalia towbar mounted cycle carrier - 2 bikes
DA5023
7-pin to 13-pin adaptor.
To use on vehicles with 7-pin towing electric sockets

- DA4118** Discovery 1 - mount to the spare wheel carrier & are easy to fit 4 Bikes
- DA4119** Discovery 2 - mount to the spare wheel carrier & are easy to fit 4 Bikes
- DA4121** Freelander 1 - mount to the spare wheel carrier & are easy to fit 3 Bikes
- STC50063** Discovery 2/Discovery 3/Discovery 4/Range Rover Sport - 2005 - 2013 2 Bikes
- VPLFR0091** Thule cycle carrier. Raised roof rails & crossbar kit required - more information Thule page 1 Bike
- DA4316** 'Scott' - cycle carrier - for more information see Mont Blanc page 1 Bike
- DA4317** 'Barracuda' - cycle carrier - for more information see Mont Blanc page 1 Bike



Ladders



RBL0526SSS

Easy access to your roof rack.

DA1089	Defender 90/110 Series SWB/LWB	Galvanised Non-drill type
DA3073	Defender 90/110	Grey
DA3073B	Defender 90/110	Black
DA4710	Defender 90/110 Safety Devices	Black
STC50417	Defender 90/110	Black
STC50134	Discovery 2	Black
VPLAR0164LR	Discovery 3/Discovery 4	Black
RBL0526SSS		Black

A rear ladder mounted from Safety Devices' Defender 90 and 110 roll cage and Land Rover lower chassis mounting points.

Roof Racks

Galvanised Roof Rack Kits

DA1093



FLAT FLOOR ROOF RACK

DA1091



CONTOUR FLOOR ROOF RACK



Short Wheel Base Flat Packed Galvanised Roof Racks

Length - 1,990mm (78½")
 Height - 420mm (16½");
 Width - 1,460mm (57½")
 Weight - 25kg

DA1093	Defender 90/Series SWB	Flat floor
DA1091	Defender 90/Series SWB	Contour floor

Long Wheel Base Flat Packed Galvanised Roof Racks

Length - 2,800mm (110½")
 Height - 420mm (16½");
 Width - 1,460mm (57½")
 Weight - 30.5kg

DA1090	Defender 110/Series LWB	Flat floor
DA1092	Defender 110/Series LWB	Contour floor

DA1089	Ladder - for above kits	Galvanised Non-drill type
---------------	-------------------------	------------------------------

Note - Contour racks must not be used on vehicles fitted with a sunroof.

DA1089



Thule

Roof Bars

Maximum load weight of 80kg.
 Complete with a pair of black square bars.

Gutter Mount Fitment

DA2990	Defender - 90/110	Lockable	1,630mm wide
DA2990	Discovery 1	Lockable	1,630mm wide
DA2991	Discovery 2		1,630mm wide
DA3002	Range Rover Classic		1,500mm wide

Clamp Style Fitment

DA4328	Freelander 1 - 1998 - 2003 - 3-door & 5-door	1,200mm wide
DA4326	Freelander 2	1,350mm wide
DA2996	Range Rover Sport - 2005 - 2013	1,500mm wide
DA4330	Range Rover L322	1,500mm wide

Fixed Points Fitment

DA4325	Discovery 3	1,270mm wide
DA4325	Discovery 4	1,270mm wide
DA2993	Range Rover P38	1,200mm wide

Raised Roof Rail Fitment (Cross Bars)

STC7639	Discovery 1	1,200mm wide
DA4323	Discovery 2 - up to 2003	1,350mm wide
DA4324	Discovery 2 - 2004 onwards	1,270mm wide
DA4324	Discovery 3	1,270mm wide
DA4329	Freelander 1	1,080mm wide
STC7639	Freelander 1	1,200mm wide
DA4327	Freelander 2	1,270mm wide
DA4324	Range Rover Evoque - 5-door	1,270mm wide

Cycle Carrier

VPLFR0091

- > The smartest, most elegant solution for loading and transporting a bike on the roof.
- > The self-adjusting and upright frame holder into which the bike automatically slides, makes bike loading easy.
- > Adjusting and securing is done comfortably and quickly, with a turning knob, at roof height.
- > Quick-release straps, adjustable for different wheel sizes, hold the wheels securely in place.
- > Light and convenient aluminium design.
- > Can easily be fitted on either side of the car roof.
- > Lockable - bike to bike carrier, bike carrier to load carrier.
- > Fits frame dimensions up to 100mm.



Gutter Mount Fitment



Clamp Style Fitment



Fixed Points Fitment



Raised Roof Rail Fitment



facebook.com/britpart

Front Runner

DA3077



- > All aluminium construction, fully welded
- > Powder coated finish
- > Patented slat, with grooves to accommodate 8mm bolts
- > Modular design - allow accessories to be mounted and removed as need without drilling
- > Rail towards the rear, open in the front
- > Gutter mount stainless steel clamps

DA3077	Freelander 1	Full rack	Silver
DA3086	Freelander 1	Full rack	Silver
	Original mountings		

> Racks & Roll Cages

Mont Blanc



Roof Bars & Rails

3 part roof bar kit which is tailored to suit the vehicle and easily fits to the roof with locks included.

DA4312	Discovery 3	Roof bar FlexiKit 3	Max load - 100kg	Weight - 4.5kg
DA4314	Range Rover Sport - 2005 - 2013	Roof bar FlexiKit 3	Max load - 100kg	Weight - 4.5kg
DA4319	Range Rover L322	Roof bar FlexiKit 3	Max load - 100kg	Weight - 4.5kg

For vehicles with factory fitted roof rails.

DA4311	Freelander 1	Roof bar FlexiKit 2	Max load - 100kg	Weight - 3.3kg
---------------	--------------	---------------------	------------------	----------------

2 part roof bar kit which easily fits to the roof.

DA2311	Defender	Classic roof bars	Max load - 100kg	Weight - 5.0kg
DA2315	Range Rover P38	Classic roof bars	Max load - 100kg	Weight - 5.0kg

Universal fitting for vehicles with standard factory fitted roof rails.

DA2312	Discovery 1	Classic roof bars	Max load - 100kg	Weight - 3.4kg
DA2310	Freelander 1	Classic roof bars	Max load - 100kg	Weight - 3.3kg

Cycle Carriers

DA4316 'Scott' - cycle carrier

- > Stable easy-to-use roof mounted cycle holder.
- > Takes frame diameters from 30mm up to 80mm.
- > Lockable to roof rack as well as bicycle.
- > Frame holder with quick attachment for easy fitting without tools.
- > Wheels rest in adjustable wheel holders and are fastened with strong securing straps.
- > Can be fitted on all standard load bars and aluminium profiles.
- > Maximum load - 17kg.



DA4317 'Barracuda' - cycle carrier

- > Unique free stand feature enables ease of loading.
- > Secured in the frame holder and locks to both bicycle carrier and roof bars.
- > Chromium-plated frame holder tube in special steel.
- > Base unit made of UV-resistant composite material.
- > Takes frame diameters from 20mm up to 80mm.
- > Manufactured in accordance with DIN 75302.
- > Will fit to both standard and aluminium bars.
- > CityCrash approved.
- > Maximum load - 15kg.



For full technical specifications and more images - www.britpart.com/montblanc



Roof Boxes

DA4332 Vista 540 - full width
540 litres
2,000 x 950 x 420mm (L x W x H)
Weight - 17kg

DA4331 Vista 380 - half width
380 litres
2,000 x 650 x 450mm (L x W x H)
Weight - 15kg

- > Lock up struts - new improved design with side opening for ease of loading.
- > Three point central lock system.
- > 80mm width fixings to suit most roof bar sizes.
- > UV resistant, high impact ABS.
- > Load securing straps included.



Land Rover

Defender	Range Rover
VPLDR0063 Defender 90	LR006849 Range Rover P38
VPLDR0064 Defender 110	Range Rover Sport
STC7582 Defender - all models	CAB500130PMA Range Rover Sport 2005 - 2013
Discovery	Range Rover Sport 2005 - 2013
STC8057AC Discovery 2	2014 onwards
VPLAR0001 Discovery 3/Discovery 4	LR006848 Range Rover Sport 2005 - 2013
LR006848 Discovery 3/Discovery 4	VUB502130 Range Rover Sport 2005 - 2013
LR006849 Discovery 3/Discovery 4	LR006849 Range Rover Sport 2005 - 2013 & 2014 onwards
Freelander	CAB500070PMA Range Rover L322
LR002417 Freelander 2	Range Rover L322
LR006848 Freelander 2	Range Rover L405
LR006849 Freelander 2	Range Rover L322
	Range Rover L405
	LR006848 Range Rover Evoque
	LR006849 Range Rover Evoque

For images please visit - www.britpart.com/racks

Britpart Expedition



These roof racks are manufactured from aluminium with a smart black powder coated finish. Fully welded, they are extremely strong, versatile and easy to use. The floor plank profiles are orientated longitudinally which results in a reduction in wind noise. There are nut channels on all the extrusions to allow for easy fitment of 3rd party accessories.

DA3072

Defender 90
3 feet per side
Weight - 32kg
Dimensions - 2,050mm long x 1,500mm wide
Vehicle gutter to top of rack - 265mm

DA3070

Defender 110
4 feet per side
Weight - 38kg
Dimensions - 2,750mm long x 1,500mm wide
Vehicle gutter to top of rack - 265mm

DA3269

Defender 110 Double cab pickup
Defender 130 Double cab pickup
3 feet per side
Weight - 27kg
Dimensions - 1,600mm long x 1,500mm wide
Vehicle gutter to top of rack - 265mm

DA6529

Discovery 1 & Discovery 2
Low profile
3 feet per side
Weight - 26kg
Dimensions - 2,050mm long x 1,500mm wide
Vehicle gutter to top of rack - 265mm
Note - Will only fit vehicles without factory fitted roof rails.

DA6629 NEW

Discovery 1 & Discovery 2
Low profile
3 feet per side
Weight - 27kg
Dimensions - 2,050mm long x 1,500mm wide
Vehicle gutter to top of rack - 340mm

DA6537

Discovery 3 & Discovery 4
4 feet per side
Weight - 23kg
Dimensions - 2,300mm long x 1,260mm wide
Roof to top of rack - 120mm
Note - May need roof rail kit (CAB500120PVJ or CAP500090) to be fitted to vehicle prior to roof rack installation.

DA3070



More images online at www.britpart.com/expedition

DA6529



DA3072



DA3072



DA6529



DA6629



DA6529



DA6629



DA6537



DA6537



DA6537



DA6537



Photo courtesy of Liam Davison

Safety Devices



Defender 90 Hard Top and Station Wagon - Full Length Rack

Defender 110 Hard Top and Station Wagon - Three Quarters Length Rack

3 roof cross rails as standard and can accommodate 2 additional roof cross rails.

DA4702	Short luggage rail	Gutter mount	2.0m x 1.4m	32kg
DA4712	Short luggage rail	Roll cage mount	2.0m x 1.4m	30kg
DA4703	Long luggage rail	Gutter mount	2.0m x 1.4m	32kg
DA4713	Long luggage rail	Roll cage mount	2.0m x 1.4m	30kg
DA4724	Full luggage rail	Gutter mount	2.0m x 1.4m	50kg
DA4723	Full luggage rail	Roll cage mount	2.0m x 1.4m	45kg
DA4704	Marine ply floor		2.0m x 1.4m	16kg

Refer to owners handbook for recommended maximum weight.

Safety Devices Explorer Roof Rack Range

- > Heavy-duty steel roof rack.
- > Explorer roof racks can be affixed with a system of detachable roof cross rails to the rainwater gutters or with aluminium clamps to fit directly on to the majority of Safety Devices' external roll cages.
- > A rain gutter mounted roof rack can be converted in to a roll cage mounted roof rack with the appropriate fitting kit.
- > The standard pack includes a steel roof rack, fixing bolts and optional roof cross rails.
- > Roof racks are grit blasted, primed with a zinc enriched powder undercoat, and finished with a durable black powder coat.
- > Not compatible with a sunroof.
- > Tents can normally be affixed to the roof rack without a floor, although a marine ply non-slip floor is also available.
- > Additional roof cross rails are available to purchase for use without a roof rack for use as, for example, a roof bar, basic tent support, attaching a roof storage box or to spread additional load on the Safety Devices' roof racks.



Discovery 2

DA4732

Discovery 2 with roof rails

Highlander' roof rack for mounting to the rain gutter. Full luggage rail which neatly follows the profile of the vehicle's roof. 4 lamp brackets at the front, 1 at the rear. Roof rack will also fit with factory fitted 'oversized' roof bars. Weight: 29kg. Roof racks are grit blasted, primed with a zinc enriched powder undercoat, and finished with a durable black powder coat. Will allow limited use of the sunroofs although cannot be opened fully.

DA4733

Marine ply floor for DA4732 (1 floor with 2 'levels' plus all stainless and galvanised hardware for mounting). Weight: 19kgs.

Defender 110 Hard Top and Station Wagon - Full Length Rack

4 roof cross rails as standard and can accommodate 3 additional roof cross rails.

DA4705	Short luggage rail	Gutter mount	2.8m x 1.4m	42kg
DA4714	Short luggage rail	Roll cage mount	2.8m x 1.4m	40kg
DA4706	Long luggage rail	Gutter mount	2.8m x 1.4m	42kg
DA4715	Long luggage rail	Roll cage mount	2.8m x 1.4m	40kg
DA4725	Full luggage rail	Gutter mount	2.8m x 1.4m	55kg
DA4716	Full luggage rail	Roll cage mount	2.8m x 1.4m	50kg
DA4707	Marine ply floor		2.8m x 1.4m	23kg

Refer to owners handbook for recommended maximum weight.

Defender 110 and 130 Double Cab/Crew Cab Pick-Up

2 roof cross rails as standard and can accommodate 2 additional roof cross rails.

Not compatible with ladders.

DA4708	Short luggage rail	Gutter mount	1.6m x 1.4m	26kg
DA4731	Full luggage rail	Roll cage mount	1.6m x 1.4m	30kg
DA4709	Marine ply floor		1.6m x 1.4m	12kg

Refer to owners handbook for recommended maximum weight.

DA4711

Additional roof cross rail 4kg

Gutter mount

DA4717

Additional roof cross rail 4kg

Roll cage mount

DA4710

Roof ladder 6.5kg

Mounts to rain gutter and cross-member.

For use with DA4702, DA4703, DA4705 & DA4706

DA4711



Short luggage rail with rain gutter mount, ideal for side loaded tents.

Long luggage rail with rain gutter mount, ideal for front or back loaded tents.



Photo courtesy of Edwin Remsburg

Safety Devices - continued

DA4720 / DA4721



DA4718



Safety Devices®

For more Safety Devices roof rack images
www.britpart.com/safety-devices-racks

Safety Devices 'G4 Expedition' Roof Rack Range

- > An 'all in one' rack without detachable parts and a luggage rail which completely surrounds the roof rack.
- > The roof rack neatly follows the profile of the roof to provide two floor levels and fixes to the rainwater gutter only. This roof rack cannot be fitted to a vehicle where an external roll cage has been fitted.
- > Includes 4 spotlight brackets at the front and 1 spotlight bracket at the rear.
- > Heavy duty steel roof rack, grit blasted, primed with a zinc enriched powder undercoat, and finished with a durable black powder coat.
- > Does not allow a sunroof to be opened.
- > Not compatible with a roof tent.
- > Standard pack includes a steel roof rack and rain gutter fixing bolts.

DA4722



Defender 90 Station Wagon or Hard Top

DA4718	1.9m x 1.2m roof rack with full luggage rail for mounting to rain gutter. Dimensions refer to the usable loading area.	30kg
	Marine ply floor (two floor levels)	
DA4719	Upper section - 1,220mm (w) x 1,405mm (l) x 10mm (h) Lower section - 1,220mm (w) x 540mm (l) x 10mm (h)	12kg
DA4722	Ladder which mounts to roof rack and chassis. Only suitable for attaching to DA4718 & DA4720	8kg

Defender 110 Station Wagon or Hard Top

DA4720	2.6m x 1.2m roof rack with full luggage rail for mounting to rain gutter. Dimensions refer to the usable loading area.	40kg
	Marine ply floor (two floor levels)	
DA4721	Upper section - 1,220mm (w) x 2,128mm (l) x 10mm (h) Lower section - 1,220mm (w) x 540mm (l) x 10mm (h)	15kg
DA4722	Ladder which mounts to roof rack and chassis. Only suitable for attaching to DA4718 & DA4720	8kg



Photo courtesy of David Sherwood

Roll Cages

RBL1727SSS



RBL1857SSS



RBL2447SSS



Safety Devices®

Defender 90, 110 & 130

RBL1383SSS

4 Point external front roll cage

- Defender 90 Station Wagon without bulkhead, 2-door
- Defender 90 Station Wagon with bulkhead, 2-door
- Defender 110 Station Wagon, 4-door
- Defender 110 Crew Cab/Double Cab Pick-up, 4-door

RBL2303SSS - Silver

RBL2303SSSBLACK - Black

Full external style bar

- Defender 90 Hard Top with bulkhead, 2-door
- Defender 90 Hard Top without bulkhead, 2-door
- Defender 90 Station Wagon without bulkhead, 2-door
- Defender 90 Station Wagon with bulkhead, 2-door
- Defender 110 Hard Top, 2-door
- Defender 110 Station Wagon, 4-door
- Defender 110 Crew Cab/Double Cab Pick-up, 4-door
- Defender 130 Station Wagon, 4-door
- Defender 130 High Capacity Crew Cab Double Cab Pick-up, 4-door

RBL0526SSS

Ladder

A rear ladder mounted from Safety Devices' Defender 90 and 110 roll cage and Defender lower chassis mounting points.

RBL1907SSS



RBL2137SSS



RBL2437SSS



RBL2437SSS

6 point full external bolt-in roll cage

- Defender 110 - 2007 - 2015
- Double Cab Pickup 4-door

20-6000-755 NEW

Mounting bracket suitable for any Safety Devices Expedition external roll cage, as well as other roll-cages using 45mm diameter tubing.



Defender 90

RBL1387SSS

8 Point external front roll cage with internal rear roll cage

Black

- Defender 90 Station Wagon without bulkhead, 2-door

RBL1087SSS

6 Point full external roll cage

Black

- Defender 90 Station Wagon with bulkhead, 2-door
- Models between 1983 - 1988 had three raised ribs on the roof approx 22mm (7/8") tall. This kind of roof does not work with our external roll cages as the hoops will clash with them.

RBL2137SSS

6 Point full external roll cage

Black

- Defender 90 Hard Top without bulkhead, 2-door
- Defender 90 Station Wagon without bulkhead, 2-door

RBL1887SSS

8 Point multi-point external/internal bolt-in roll cage

Black

- Defender 90 Soft Top 2-door (1983-present)
- Utilises existing hood which will need modification. Front legs are NAS style.

RBL2367SSS NEW

6 Point bolt-in internal rear heavy duty hood stick replacement

- Defender 90 Soft Top 2-door (1983-present).
- Replaces soft-top hood sticks. 45mm tube diameter, no diagonal, backstays to waist rail includes front and rear seat belt anchor points. Roll cage fits with standard hood.

For more Safety Devices roll cage images - www.britpart.com/roll-cages

Defender 110

RBL2057SSS

8 point multi-point bolt-in full roll cage

Black

- Defender 110 Td5 Double Cab Pickup 4-door (1998-2006)
- With front external roll cage and rear internal roll cage

RBL1907SSS

Full external multi-point bolt-in roll cage

Black

- Defender 110 Hard Top, 2-door
- Made to NAS specification

RBL1727SSS

8 Point full external / internal roll cage

Black

- Defender 110 Station Wagon, 4-door
- The cage will not fit vehicles with the external ribs fitted on the roof, nor will it fit if the rear seat box is stepped in the rear corner. For clarification, see Safety Devices website.

RBL1727PAD

Internal roll cage padding

Black

- Defender 110 Station Wagon, 4-door
- Moulded polyurethane protective padding. 16mm thickness. 4 x 1,000mm lengths.

RBL2427SSS

6 Point full external roll cage

Black

- Defender 110 Station Wagon, 4-door
- Models between 1983 - 1988 had three raised ribs on the roof approx 22mm (7/8") tall. This kind of roof does not work with our external roll cages as the hoops will clash with them.

RBL1857SSS

10 point full external bolt-in roll cage

Black

- Defender 110 Crew/Double cab pick-up 4-door - 1983 onwards

RBL2447SSS

Heavy-duty hood stick set

Black

- Defender 110 200Tdi soft top 2-door - 1990 - 1993
- Set completely replaces soft-top hood sticks. 45mm tube diameter, no diagonal, backstays to waist rail, includes front belt anchor points.

Freelander 1

RBL1506SSS

14 point multi-point bolt-in competition internal roll cage for cross door bars

Black

- Freelander 1 3-door & 5-door
- Rear roll cage has cross diagonal in backstays, harness bars, tunnel brace & lower backstays.

RBL150FFK NEW

Fitting kit for RBL1506SSS.

RBL2303SSS



RBL1727PAD



Add some extra protection to your Land Rover

RBL2303SSSBLACK



Load Securing System

Bungee Clic Load Securing Starter Kit

DA5040

- > Bungee Clic, a complete system for securing loads and objects.
- > It can be customised in a variety of ways to build the correct length ties needed for securing a variety of objects
- > It gives you all you need to build and adjust safe custom-length ties to suit your needs and requirements.
- > No more unsafe coupling or wrong lengths.
- > It can be used to secure loads at work, at home or out camping.
- > Min/max working load for all items - 0 - 80kg.



Kit Contents

- 2 x J-hooks
- 2 x Locking hooks
- 1 x Straight connector
- 1 x 90 - 135cm bungee cord
- 1 x 60 - 90cm bungee cord
- 1 x 30 - 45cm bungee cord

Bungee Clic Additional Accessories

- DA5041** Bungee Clic J hooks - twin pack
- DA5042** Bungee Clic Locking hooks - twin pack
- DA5043** Bungee Clic Straight connectors - twin pack
Straight connectors provide precision length for every job.
- DA5044** Bungee Clic Y connector - single pack
Y connectors allow you to build netting shapes
- DA5045** Bungee Clic Wall mounts - twin pack
The Wall mount offers solid and permanent anchoring; inside your Land Rover or behind any door.
- DA5046** Bungee Clic Adjustable hooks - twin pack
The adjustable hooks let you quickly adjust and set the bungee cord the right length and position.
- DA5047** Bungee Clic 30cm cords - twin pack
30cm extends up to 45cm
- DA5048** Bungee Clic 60cm cords - twin pack
60cm extends up to 90cm
- DA5049** Bungee Clic 90cm cords - twin pack
90cm extends up to 135cm
- DA5050** Bungee Clic 120cm cords - twin pack
120cm extends up to 160cm

DA5041



DA5042



Customised in a variety of ways & used to secure loads at work, at home or out camping.

DA5043



DA5044



DA5045



DA5046



DA5047



DA5048



DA5049



DA5050



Photo courtesy of Pamela Blair



Photo courtesy of Kristjan Kristjansson

Wheels

Smarten up your Land Rover with a new set of wheels!

Our wide selection means that there is a design and colour to suit your needs. Make sure not to get caught out with a flat tyre with monitoring, maintenance and repair kits to keep your tyres in excellent condition.

Black Wheel Nuts	43
Spare Wheel Carriers	40
Speedo Healer	43
Tyre Monitoring & Repair	
Air compressors.....	40 - 41
ARB tyre maintenance.....	41
Inner tubes.....	40
Tyre pressure monitoring system.....	40
Tyre repair kit.....	40
Valve Caps	40
Wheel Protection	
Locking wheel nuts, keys & caps.....	42
Spare wheel covers.....	42
Spare wheel protectors.....	42
Wheel Spacers & Adaptors	
Wheel adaptor kits.....	42
Wheel spacers.....	42
Wheel Wrenches	42
Wheels	
Alloy.....	44
Bowler.....	45
MaxXtrac.....	45
MaxXtrac Blindo.....	45
Steel.....	43
Zu.....	46



Spare Wheel Carriers



DA2232



VPLDR0130



DA2274



DA2274CABLE

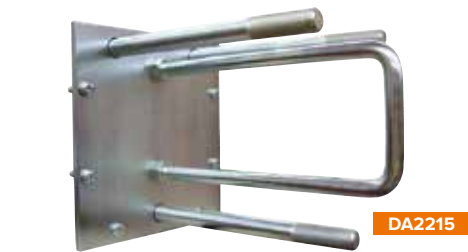

DA2215

- DA2232** Defender - all models/Series Swing away rear door mount
- VPLDR0130 NEW** Defender - all models/Series Swing away rear door mount
- DA2274** Defender - with half door tailgate Swing away rear door mount
- DA2274CABLE** Spare cable for DA2274
- DA2215** Defender/Series Fixed rear door mount
- 345510** Series/Military Replacement strap for fixing your spare wheel to the bonnet.



345510

Inner Tubes

- DA3000** 7.50 x 16 Uses TR15 (large) type valve
- DA3201** 205 x 16 Uses TR13 (small) type valve



Tyre Monitoring & Repair



Are your tyres at the right pressure?

DA4512

This system is an advanced monitoring & alert system of tyre conditions. It monitors tyre pressure and temperature then relays the state of each tyre to a display unit. When any abnormalities are detected, the system will display the status of the affected tyre and sound an alarm to ensure you take action to remedy the problem. Keeping your tyres in good condition at the right pressure can extend the life of your tyres, reduce fuel consumption and improve handling. **Note** - This system will only measure up to a maximum of 3.5 bar.

- Tyres that are at the right pressure will -
- > Improve fuel consumption
 - > Increase the tyre life span
 - > Help enhance vehicle handling & braking
 - > Reduce susceptibility to hydroplaning

- System contents -
- 1 x Display
 - 1 x Receiver
 - 4 x Tyre sensors
 - 3 x Display brackets
 - 2 x 3M stickers
 - 1 x Instruction manual

Air Compressors



DA2392

Double-pump air compressor
Air flow - 150ltr/min

It's no good being able to repair your tyres if you can't inflate them. Full details of these air compressors can be found in the off-road section.



DA2354

Single-pump air compressor
Air flow - 72ltr/min



DA5078 NEW
Rapid digital air compressor



Valve Caps



- LR027664** Red, white & blue Union flag Set of 4
- LR027666** Black, white & grey Union flag Set of 4

Enhance your wheels with a set of smart aluminium valve caps.

Tyre Pressure Monitoring System

Tyre Repair Kit

Don't get caught out with a flat tyre or two!



DA2390 - Tyre repair* kit in travel case
How It Works

1. Find and remove the item that caused the puncture.
2. Apply rubber solution to the reamer tool then push the reamer into the puncture and work up and down until the reamer moves easily in the hole.
3. Thread one rubber tyre plug in the hook tool.
4. Push the rubber tyre plug into the hole until 1/2" of the tyre plug remains outside the tyre then turn the hook tool a quarter turn and pull out slowly.
5. Cut off the excess tyre plug as close to the tyre as possible.
6. If the puncture is too big have the tyre fixed by a professional.

*Recommended for off-road use only.

Space Saver Wheels



DA1217 NEW
Black steel - 5.5J x 19 - RRC002882PBG
Continental tyre - 175/80 x 19
Discovery 3/Discovery 4
Range Rover Sport - 2005 - 2009/Range Rover L322

DA1417 NEW
Black steel - 4B x 18 - LR088518
Continental tyre - T155/85 x 18
Freelander 2/Discovery Sport/Range Rover Evoque

DA1230 NEW
Black alloy - 5.5 x 19 - RRC505870PBG
Continental tyre - T175/80 x 19
Range Rover Sport - 2005 - 2013

DA1231 NEW
Black alloy - 6J x 20 - LR033229
Pirelli tyre - T195/70 x 20
Range Rover Sport - Mk2/Range Rover L405



DA1217



DA1231

ARB Tyre Maintenance



- DA8927** ARB Tyre Inflator
- > Compatible with ARB air compressors.
 - > Easy to read dial with dual scale PSI/bar increments.
 - > Quality bronze Bourdon tube gauge design.
 - > Fully geared, solid brass precision movement.
 - > Protective rubber gauge guard.
 - > Air bleed button for deflating.
 - > 330mm stainless braided flexible hose.
 - > Clip on chuck.
 - > Incorporates ¼ NPT-US standard made air fitting.
 - > Internal air shut off valve.



- DA8931** ARB E-Z tyre Deflator
- The unique, patented design of the E-Z Deflator allows for removal of the valve core for rapid tyre deflation, while also providing accurate pressure reading via the simple movement of a sliding valve. Provided in a protective canvas pouch, the quality bronze Bourdon Tube gauge design ensures accuracy is not affected by fluctuations in temperature, humidity or altitude.
- > Corrosion resistant brass/stainless deflator tool.
 - > Fully geared, solid brass precision movement.
 - > Protective rubber gauge guard.
 - > Easy to read dial with one PSI increments.



- DA6825** ARB Low Air Pressure Gauge
- > Specifically designed for off road use.
 - > Lower scale for improved accuracy at lower pressures.
 - > Quality bronze Bourdon Tube gauge ensures accuracy is not affected by changes in temperature, humidity or altitude.
 - > Fully geared, solid brass precision movement.
 - > Protective rubber gauge guard.
 - > Simple to use with a large 3.5" diameter gauge.
 - > Three pressure scales (PSI, kPa and bar).
 - > Flexible hose with dual chuck for all rim and valve types.
 - > Tested and designed to stay accurate.



- DA8998** ARB Portable Air Compressor
- This portable 12V air compressor comes in a durable polypropylene carry case for added versatility and uses quality components for quiet operation and extra long life. Including a 19ft air hose, it also comes with all the necessary fittings for tire inflation and camping or leisure gear. Its twin motors are internally thermal protected against extreme temperature damage while a heavy duty in-line maxi fuse for each motor provides professional circuit protection. The compressor comes in a high quality carry case featuring internal pockets for components and accessories including a 6 metre air hose. Much more information available online.



- DA6823** ARB Twin Portable Air Compressor
- Designed to fill the market need for a compact sized yet high performance compressed air source for rapid inflation of large tyres as well as the high volume air needs of most air powered tools. The ARB compressor is a world class recreational product designed and built to commercial/industrial standards to survive harsh and demanding outdoor conditions. Much more information available online.



- DA6253** ARB Tyre Inflation Kit
- The ARB tyre inflation kit for air compressors is specially sourced from Japan, providing a unique high-heat tolerant hose for the hi-output compressor (DA4190). The practical kit includes a dust resistant air chuck and an enclosed internal bearing system to prevent dirt ingestion.
- > Suitable for camping, touring and off-road applications as well as everyday usage.
 - > Provides fast, accurate inflation.
 - > Kit includes
 - 1 x high heat pressure hose.
 - 1 x ARB air chuck with quick press fitting.
 - 1 x ARB T-fitting for use with the ARB air compressor (DA4190) and an assortment of additional fittings to suit various camping and sporting gear such as air mattresses and footballs.



- DA6842** ARB Inflation Case
- Designed to keep all your ARB air accessories secure in the one bag and easy to reach, the ARB Inflation Case is a simple yet highly functional solution. Designed with six specialised pockets, fit to house ARB Inflation, ARB Deflation, ARB Gauges, ARB Hoses and other general air accessories, this simple and convenient case keeps all your accessories organised and secure in the one bag. Externally, ARB's bright orange topographical design insures the case itself will not get lost within the back of your vehicle. It has also been manufactured to incorporate the highest of quality materials, from the handle to the internal pockets, ensuring the durability of the case. World renowned YKK#10 zippers appear internally and externally on the case and an abrasion resistant canvas is used to protect your air accessories from outside elements. For ease of use, a large durable rubber handle can be used to carry the case and a high-vis reflective tapping appears on the outside of the case for safety.



- DA8930** ARB Speedy Seal Puncture Repair Kit
- Coming in a compact, high visibility carry case, the Speedy Seal includes all the components necessary to repair tubeless radial or cross ply tyres, without removing the tyre from the vehicle or rim. A pencil type tyre gauge with dual chuck makes setting pressures a snap, while a spring steel insertion needle and hardened reamer tool allow fast tyre repairs.
- > Lubricant for easier tool insertion.
 - > Additional accessories (valve core tool, spare valves and valve caps).
 - > 30 self vulcanising repair cords for complete air sealing.
 - > Allen keys.



4X4 ACCESSORIES



- DA6824** ARB Compressed air blow gun

ARB products available in the UK only.

Wheel Protection

Locking Wheel Nuts, Keys & Caps

Protect your valuable wheels & tyres

Locking wheel nut keys

Defender
Discovery 1
Discovery 2
Range Rover P38

	Locking wheel nuts	Locking wheel nut keys
Code A	STC3410	STC3580
Code B	STC3411	STC3581
Code C	STC3412	STC3582
Code D	STC3413	STC3583
Code E	STC3414	STC3584
Code F	STC3415	STC3585
Code G	STC3416	STC3586
Code H	STC3417	STC3587
Code I	STC3418	STC3588
Code J	STC3419	STC3589

Locking wheel nuts
Freelander 1 - up to 2006

	Locking wheel nuts	Locking wheel nut keys
Code A	RRD100520	KBM100450
Code B	RRD100530	KBM100460
Code C	RRD100540	KBM100470
Code D	RRD100550	KBM100480
Code E	RRD100560	KBM100490
Code F	RRD100570	KBM100500
Code G	RRD100580	KBM100510
Code H	RRD100590	KBM100520
Code I	RRD100600	KBM100530
Code J	RRD100610	KBM100540

For more images www.britpart.com/nuts



STC50080

Locking wheel nuts & key kits

STC7623LR

Defender with Deep Dish alloy wheels
Kit - 5 x nuts; 5 x caps; 1 x key

STC3601

Defender/Discovery1/Range Rover Classic - 1989 - 1994 with alloy wheels

Kit - 5 x nuts; 5 x caps; 1 x key; 1 x black bag for key

RTC9535

Defender/Discovery 1/Range Rover Classic - 1989 - 1994 with steel wheels

Kit - 5 x nuts; 1 x key (black finish)

STC8843AA

Defender/Discovery 1/Range Rover Classic - 1989 - 1994 with alloy wheels (not deep dish)

Kit - 5 x nuts; 5 x caps; 1 x key

RRB100510

Discovery 2 with alloy wheels

Kit - 1 x nut; 1 x cap; 1 x key; 1 x removal tool

STC50080

Discovery 2 - Full set of wheel nuts

Kit - 4 x locking nuts; 4 x spare caps;

18 x normal nuts (inc. caps); 1 x key; 1 x remover tool

ANR6091

Freelander 1

Kit - 5 x nuts; 1 x key; 1 x removal tool

RRB100370

Range Rover P38 with alloy wheels

Kit - 4 x nuts; 4 x caps; 1 x key

RRB500100

Discovery 3/Range Rover Sport - 2005 - 2009

Range Rover L322 - 2005 - 2009

Kit - 4 x nuts; 1 x key

ANR6094L	Freelander 1	Locking wheel nut cap
KBP10001	Freelander 1	Universal nut cover removal tool
RRD000100	Range Rover L322	Locking wheel nut - 35
RRD000110	Range Rover L322	Locking wheel nut - 36
RRD000120	Range Rover L322	Locking wheel nut - 37
RRD000130	Range Rover L322	Locking wheel nut - 38
RRJ000030	Range Rover L322	Locking wheel nut cap Defender
RRJ100120	Discovery 2	Locking wheel nut cap Range Rover P38

Spare Wheel Covers



DA2025

Plain black, easy to fit spare wheel covers.

DA2021	7.5 x 16
DA2022	6.0 x 16 & 195 x 80 x 15
DA2026	205 x 16
DA2025	235 x 70 x 16 & 255 x 55 x 18
DA2027	235 x 85 x 16
STC7889	Defender



[facebook.com/britpart](https://www.facebook.com/britpart)



Wheel Adaptors & Spacers

Wheel Adaptors

Convert your existing stud pattern to allow for fitment of a different style of wheel.



DA6343

Set of 4

To fit Range Rover L322 or Range Rover Sport wheels to a Discovery 2 or Range Rover P38.

DA5005



To fit Range Rover P38 wheels to Defender, Discovery 1 or Range Rover Classic

Boss height is 66.65mm

DA5005 Set of 4

DA5005S Single adaptor

DA5006



To fit Discovery 2 wheels to Defender, Discovery 1 or Range Rover Classic

Boss height is 58mm

DA5006 Set of 4

DA5006S Single adaptor

Spare Wheel Protectors



DA1156

The valuable spare wheel on the Discovery 3, Discovery 4 and Range Rover Sport - 2005 - 2013 are very vulnerable to theft. These spare wheel protectors are designed to restrict access to the winching mechanism and makes it almost impossible for anyone to steal the wheel. Easy to fit to give you piece of mind.

DA1156

Aluminium

DA1360

Steel



DA1360

Wheel Spacers

Improve your Land Rover's appearance, steering lock & handling with a set of wheel spacers.



Defender/Discovery 1/Range Rover Classic

30mm thick, steel machine finish complete with wheel nuts and OEM studs

DA5004 Set of 4

DA5004S Single spacer



Sign up to the regular Britpart newsletter to find out about all the latest product releases.
www.britpart.com/newsletter

Wheel Wrenches



NTC7829HD

537179

DA4026

537179	Wrench size - 15/16"
DA4026	Wrench size - 27mm
NTC7829	Wrench size - 27mm
NTC7829HD	Wrench size - 27mm - heavy-duty
LR011870	Wrench size - 27mm
LR011870HD	Wrench size - 27mm - heavy-duty

Wheels

Steel Wheels



Enhance your Land Rover with a set of smart new wheels.

Defender

ANR4583PM	16" x 6.5J	Primed
Wolf style - welded tubeless - use longer studs (FRC7577)		
ANR4583SILVER	16" x 6.5J	Silver
Wolf style - welded tubeless - use longer studs (FRC7577)		
VPLDW0095PVT	16" x 6.5J	Black gloss
Wolf style - welded tubeless - use longer studs (FRC7577)		
ANR4636PM	16" x 5.5F	Primed
Standard - welded tubed		
ANR5593PM	16" x 6.5J	Primed
Wolf style - welded tubed		
DA3187	16" x 7	White
8-spoked - welded tubeless		
RRC503600PM	16" x 5.5J	Primed
Standard - welded tubeless Defender - 1987 onwards		
LR053845	16" x 5.5J	Primed
Standard - welded tubeless Defender - 2007 onwards		

Discovery

DA3187	16" x 7	White
8-spoked - welded tubeless Discovery 1		
NTC5193PM	16" x 7JH	Primed
Discovery 1		

Freelander

ANR3973	15" x 5.5J	Silver
Freelander 1		

Range Rover Classic

DA3187	16" x 7	White
8-spoked - welded tubeless		

Series

ANR4636PM	16" x 5.5F	Primed
Standard - welded tubed		

Black Wheel Nuts



DA2548 NEW	Black single nut
Black locking wheel nut kit	
Discovery 3/Discovery 4/Range Rover/Range Rover Sport	
RRD500560B NEW	Black single nut
Defender - 2007 onwards	
Discovery 1/Range Rover Classic	
DA3548 NEW	Black single nut
Black locking wheel nut kit	
Defender - 2007 onwards	
Discovery 1/Range Rover Classic	

LR068126B NEW	Black single nut
Discovery 4/Discovery 5	
Range Rover L322 - 2010 - 2012	
Range Rover L405	
Range Rover Sport - Mk1 - 2010 - 2013	
Range Rover Sport - Mk2	
RRD500510B NEW	Black single nut
Discovery 4	
Range Rover L322 - 2010 - 2012	
Range Rover L405	
Range Rover Sport - Mk1 - 2010 - 2013	
Range Rover Sport - Mk2	

Speedo Healer NEW

DA1343 NEW
 Defender - Td5 & 2007 onwards
 Behind the handbrake backplate, on later Defenders, is a green 3 wire transducer which generates a pulse. This is then sent to the speedometer to show your vehicle's speed. Fitting different sized tyres or a non-standard ratio ring and pinion in the diffs could well mean the speed displayed is inaccurate. Fitting and programming this small box is easy. Once installed it allows you to adjust the output pulse, both up and down, which means your speedo will indicate the correct speed at which you are travelling. The instructions included detail how easy it is to program the box using a sat nav system.



Alloy Wheels



Defender			
ANR3631MNH		16" x 7	Deep Dish alloy
ANR5307MNH	TA onwards	16" x 7	Tornado alloy
RRC503400MNH	1994 onwards	16" x 7	Boost alloy
LR023391BLK	1994 onwards	16" x 7	Boost alloy - black gloss
Sawtooth style alloys			
ET20 / Load 1,000kg / JWL tested / Defender PCD / Standard wheel nuts			
LR025862	1994 onwards	16" x 7	Black
LR025862MNH	1994 onwards	16" x 7	Silver
DA6548	1994 onwards	18" x 8	Black
DA6549	1994 onwards	18" x 8	Silver

Discovery			
ANR3631MNH	Discovery 1	16" x 7	Deep Dish alloy
ANR5307MNH	Discovery 1	16" x 7	Tornado alloy
RRC501470MCM	Discovery 2	18" x 8	Hurricane alloy
RRC505360MNH	Discovery 3/Discovery 4	18" x 8	10-spoke alloy Silver sparkle finish

Range Rover			
RRC501470MCM	Range Rover P38	18" x 8	Hurricane alloy
RRC505360MNH	Range Rover Sport - 2005 - 2009	18" x 8	10-spoke alloy Silver sparkle finish
RRC505370MNH	Range Rover Sport - 2005 - 2009	19" x 9	10-spoke alloy Silver sparkle finish

Note - Centre caps and wheel nuts not included with any wheels.

*Enhance your Land Rover
with a set of smart new wheels.*



Note - It is the responsibility of the vehicle owner to ensure that the wheels fitted to their vehicle have an appropriate load rating. The minimum required load rating can be determined by taking the manufacturers recommended maximum axle weight and dividing by two.

MaxXtrac - Mach 5



DA2471



DA2472



DA2473

MaxXtrac Mach 5 alloy wheels
 Defender
 Discovery 1
 Range Rover Classic
 Engineered in UK & supplied with 5 standard wheel nuts.

DA2477

- > Size - 16" x 8
- > Offset - et 10
- > Load rating - 1,450kg

DA2478

	Wheel	Wheel Centre
Satin Black	DA2471	DA2476
Anthracite	DA2472	DA2478
Silver	DA2473	DA2477
DA2474	Set of 5 spare wheel nuts	
DA2475	Set of 5 locking wheel nuts	



DA2475

DA2474



MaxXtrac - Blindo



DA2488



DA2489

Defender/Discovery 1/Range Rover Classic

Specifications

- > Size - 16" x 7"
- > PCD - 5 x 165.1
- > Offset - et 15
- > Weight - 14.3kg

DA2488 Anthracite

DA2489 Black

ANR2763MMM

Wheel nut

Single



Smart looking, tough, high quality alloy wheels which are ideal for off-road use. Used for rally-road competition vehicles as well as the military these Blindo wheels are TÜV approved and manufactured in Italy.

- > Only prime aluminium is used.
- > Less silicon is added than cheaper alloy wheels.
- > Alloys are heat-treated for improved mechanical properties.
- > Metal is de-gassed to remove any small bubbles.
- > Low pressure cast to ensure improved metal density.
- > Once made each alloy is x-rayed to check for defects, then water tank pressure tested to ensure no leaks.

Bowler Lightweight **NEW**



DA1346



DA1347

Made in the UK exclusively for Bowler, these lightweight, high strength wheels are TÜV tested and are used in the Defender Challenge. They have a manufacturers guarantee and are used extensively in motorsport. Maximum load rating 1,250kg.

Bowler 18" Lightweight Wheels

They are 8" wide and will accept tyres ranging from 255 - 285 wide.

DA1346 **NEW** Black

DA1347 **NEW** Anthracite

Bowler 16" Lightweight Wheels

They are 7½" wide and will accept tyres ranging from 235 - 265 wide (including standard 16" Land Rover options of Continental Cross Contacts or Goodyear MTR).

DA1350 **NEW** Black

DA1349 **NEW** Anthracite



DA1350



DA1349

Note - It is the responsibility of the vehicle owner to ensure that the wheels fitted to their vehicle have an appropriate load rating. The minimum required load rating can be determined by taking the manufacturers recommended maximum axle weight and dividing by two.

Zu Wheels

- > Super strong
- > Super Light
- > TÜV approved and meets or exceeds UK - European - U.S. - Canadian - Australian - South African and Japanese wheel manufacturing specifications
- > Uses standard Land Rover alloy wheel nuts
- > Easy to balance
- > Manufactured in the UK

Defender/Discovery 1/Range Rover Classic

16 x 7 Rims

- > 11mm + VE offset
- > 1,400kg rating
- > 10.4kg each

DA2437	Anthracite - gloss
DA2436	Black - gloss
DA2439	Black - matt
DA2435	Silver
DA2434	White

Note - Wheel nuts not included

ANR2763MMM	Alloy wheel nut
Defender - up to 2006/Discovery 1/Range Rover Classic	
RRD500560	Alloy wheel nut
Defender - 2007 onwards	

Discovery 2/Range Rover P38

16 x 8 Rims

- > 38mm + VE offset
- > 1,400kg rating
- > 12.0kg each

DA2433	Anthracite - gloss
DA2432	Black - gloss
DA2438	Black - matt
DA2431	Silver
DA2430	White

18 x 8 Rims

- > Part number includes wheel adaptor ring
- > 36mm + VE offset
- > 1,400kg rating
- > 12.0kg each

DA2458	Anthracite - gloss
DA2459	Anthracite - matt
DA2456	Black - gloss
DA2457	Black - matt
DA2461	High Power Silver
DA2460	Silver

Note - Centre caps and wheel nuts not included

RRD500510	Alloy wheel nut
LR089424LR	Wheel cap
Discovery 2/Range Rover P38	

Discovery 3/Discovery 4*/Range Rover Sport* & Range Rover L322*

18 x 8 Rims

- > 36mm + VE offset
- > 1,400kg rating
- > 12.0kg each

DA2452	Anthracite - gloss
DA2453	Anthracite - matt
DA2450	Black - gloss
DA2451	Black - matt
DA2455	High Power Silver
DA2454	Silver

Note - Centre caps and wheel nuts not included

***Note** - Zu rims will not fit any Range Rover L322 Supercharged or Range Rover Sport Supercharged fitted with Brembo brake callipers. Will only fit Discovery 4 with 2.7ltr engine.

RRD500510G	Alloy wheel nut
Discovery 3/Discovery 4/Range Rover Sport - 2005 - 2013	
RRD000011	Alloy wheel nut
Range Rover L322	
LR089424LR	Wheel cap
Discovery 3/Discovery 4	
Range Rover Sport - 2005 - 2009/Range Rover L322	

ANTHRACITE - GLOSS



ANTHRACITE - MATT



BLACK - GLOSS



BLACK - MATT



HIGH POWER SILVER



SILVER



WHITE



Super **Strong**
Super Light

BRITPART
EXCLUSIVE UK
TRADE DISTRIBUTOR



Note - It is the responsibility of the vehicle owner to ensure that the wheels fitted to their vehicle have an appropriate load rating. The minimum required load rating can be determined by taking the manufacturers recommended maximum axle weight and dividing by two.

Lighting

Our wide selection of lights allow you to replace broken lights or upgrade your existing lights to something more powerful. These lights will help you be better seen on the road and ensure that you can clearly see what is ahead of you. We also have inspection lights to help increase visibility when looking under your Land Rover's bonnet.

Exterior Lights	
Driving lights	48
Fog lights	48
Roo-lites	49
LED Bumper	49
LED Light Bars	52
Light Conversion & Upgrades	
Britpart Lynx Eye LED headlamps	51
Clear lights	51
ECE LED headlamps	51
Heater control light upgrade kit	51
Individual lights - LED	50
LED interior festoon bulbs	50
Light kits	49
Replacement headlamps	50
Xenon headlight bulbs	51
Xenon headlight upgrade	51
Light Mountings	
Light bars	52
Light mounting kits	52
Spare Light Bulb Kits	51
Work Lights	
Exterior lights	52
Inspection lamps	53



Exterior Lights



DA4088

- > 100 watt
- > Universal fitting
- > High power halogen lamps
- > Fits all 12 volt vehicles
- > Easy installation
- > Armoured cable
- > Fitted plastic stone guards
- > Excludes wiring kit

DA4088	8" Light	Black	Pair
DA4088C	8" Light	Chrome	Pair
DA4088W	Wipac 8" Light	Black	Pair

DA4088BULB

Replacement 100 watt bulb for DA4088; DA4088C & DA4088W

DA4088COVER

Replacement cover for DA4088; DA4088C & DA4088W



DA4088W

Driving Lights

DA4099	Hella Rallye 3000	Black	Single
PRC8238	Spoiler lamps classic	Black	Pair
STC7644	Hella Rallye 1000 long range	Black	Single
STC8480LR	Safari 5000	Black	Single
	Defender - 1987 - 2006/Discovery 1/Discovery 2/Range Rover Classic - 1992 - 1994/Range Rover P38	Black	Pair
XQB500080	Discovery 3	Driving light kit - includes electrics	

Replacement Light Guards

DA4398	For STC7644	Solid	White	Single
---------------	-------------	-------	-------	--------



DA4099



PRC8238



STC8480LR



XQB500080

Fog Lights

STC7643



RTC8922

Defender - up to 2006/Range Rover Classic
Hella Comet 550 Black Pair
Rectangular

Note - 195mm wide x 96mm high x 83mm deep

STC7643

Defender - up to 2006/Discovery 1/Discovery 2
Hella Rallye 1000 Black Single
Round

DA4398

Replacement guard for STC7643 White Single
Solid



RTC8922



STC7644

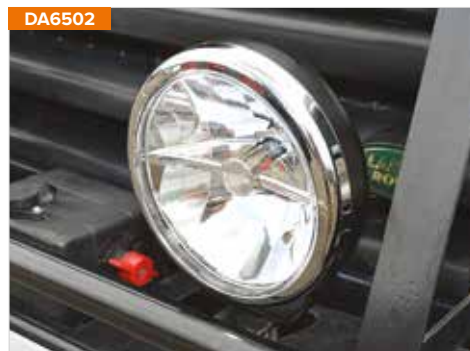

DA6502

Cibié LED Spot Lights

- DA6502** Cibié spot light - single
High performance with a large, homogeneous beam
- > Includes one Oscar LED lamp with wiring, mounting hardware, installation instructions, white protective cover with Cibié logo and Cibié sticker.
 - > Coated polycarbonate lens is waterproof, shock resistant, corrosion resistant and UV resistant.
 - > Luminous flux - 700lm
 - > Voltage - 12-24V DC
 - > Light temperature - 6,000K
 - > Candelas - 75,000 cd
 - > Length of visibility - 370m
 - > Width of visibility - 40m
 - > Safety certification - ECE/SAE/CCC

DA6503

Replacement Cibié cover Pair



Photo courtesy of Istvan Szecsodi

Roo-Lites

DA1062



DA1062 Roo-Lite
 > High performance lighting with super strength construction.
 > 7¼" round long range spot lamps with "stone-proof" clear polycarbonate lens.
 > Super strength housing with an Osram 100 watt Xenophot long life technology bulb.
 > Variable focus from spot to fog beam pattern.
 > Lightweight for reduced vibration.
 > Reflector unit is screw-on for easy bulb change.
 > 12V - 100W - 8 amps.
Note - Roolites sold individually



Exclusive to Britpart

Roo-Lite impact resistant covers

Plain

- DA1062AMBER** Amber
- DA1062BLUE** Blue - produces 'Xtra white' light
- Diffused** - suitable for fog/snow conditions
- DA1062FOGA** Amber
- DA1062FOGW** Blue - produces 'Xtra white' light
- DA1062COVER** Protective cover

Note - Roo-Lite covers sold individually

DA1063 100W Spare bulb

DA1064 Harness

Harness is of a heavy gauge wire to ensure safe operation of high wattage lamps. It includes digital switch, in-line fuse, built-in relay and wiring harness.

High performance lighting with super strength construction

DA1062AMBER / DA1062BLUE



DA1062FOGA / DA1062GOGW



DA1062COVER



DA1064



DA5678



LED Bumper

This smart and functional standard fit Defender bumper is equipped with a pair of LED lights for additional lighting in the dark or day light running for safety.

DA5678

Front bumper with LED lights

DA5679

LED lights - pair
 190mm wide x 28mm high

Light Conversion & Upgrades

Defender & Series Replacement 73mm light kits

- DA1077** Series/Defender - up to 300Tdi
- DA1077G** OEM Series/Defender - up to 300Tdi
- Defender - 300Tdi onwards
- DA1080** Defender - Td5 - up to WA159806
- Defender - 300Tdi onwards
- DA1080G** OEM Defender - Td5 - up to WA159806

Defender & Series LED 73mm light kits

- DA1191** Clear LED light kit
 Contents - 2 x Clear front sidelight; 2 x Clear front indicator; 2 x Clear rear indicator; 2 x Clear stop/tail & 1 x 12v LED flasher unit
- DA1192** Colour LED light kit
 Contents - 2 x Clear front sidelight; 2 x Amber front indicator; 2 x Amber rear indicator; 2 x Red stop/tail & 1 x 12v LED flasher unit
- DA1291** Clear deluxe LED light kit
 As per DA1191 kit with clear reverse light, clear fog light and number plate light.
- DA1292** Colour deluxe LED light kit
 As per DA1192 kit with clear reverse, red fog light and number plate light.

Defender North American Specification (NAS)

LED Upgrade Kit

- DA1143** Full kit Colour
- DA1143CL** Full kit Clear

These stylish and waterproof NAS style LED rear lamps are a brighter alternative to the traditional halogen lighting with the added additional benefits of having a longer life (typical LED life 100,000 hours) with low energy consumption. The complete LED lamp kit includes

- > 1 x reverse LED light
- > 1 x fog LED light
- > 2 x indicator LED lights
- > 2 x stop/tail LED lights
- > 6 x plinths & screws & smart load devices

- DA1274** Front kit Colour
- DA1274CL** Front kit Clear

DA114424V 24 volt smart load device kit
Note - To use the LED kit (DA1143) on a 24 volt Defender use DA114424V which replaces the 12 volt smart load device.

DA1077



DA1291



DA1143



Light Kits

DA1080G



DA1192



DA1143CL



Individual Lights - LED

Defender & Series LED Lights

- > High quality LED lights
- > Multi-voltage 9 - 33V
- > 73mm diameter
- > Wipac branded
- > Waterproof to IP67
- > E Marked and SAE Approved
- > AMP type connector fitted
- > Comes complete with stainless steel screws

Defender - 1987 - 2006 & Series 2 & 3

AMR6514LED	Front side	Clear	Single
XBD100670LED	Front indicator	Clear	Single
AMR6515LEDCL	Rear indicator	Clear	Single
AMR6513LED	Front indicator	Amber	Single
AMR6515LED	Rear indicator	Amber	Single
XFD100100LEDCL	Stop/tail	Clear	Single
XFD100100LED	Stop/tail	Red	Single

Defender - 2007 onwards

XBD500050LED			
LR048189LED	Front side	Clear	Single
XBD500010LED			
LR047798LED	Front indicator	Clear	Single
XFD500050LEDCL			
LR048187LEDCL	Rear indicator	Clear	Single
XBD500040LED			
LR048188LED	Front indicator	Amber	Single
XFD500050LED			
LR048187LED	Rear indicator	Amber	Single
XFD500040LEDCL			
LR048200LEDCL	Stop/tail	Clear	Single
XFD500040LED			
LR048200LED	Stop/tail	Red	Single
XFE500010LED			
LR048201LED	Fog - 95mm	Red	Single
XFE500010LEDCL			
LR048201LEDCL	Fog - 95mm	Clear	Single
LR048202LED	Reversing	Clear	Single
XFC100550LEDG	Number plate	NEW	Single



AMR6514LED



XBD100670LED



XFD100100LEDCL



AMR6513LED

Many more images available at www.britpart.com/lights

LED Side Repeaters - Defender - Td5 onwards

DA8530	Clear	Pair
DA8531	Smoked	Pair
DA8532	Amber	Pair



Defender 95mm Special Edition Lights

LR008982	Reverse LED	Clear	Single
LR009792	Indicator	Clear	Single
LR008913	Stop/tail LED	Clear	Single
LR008975	Fog LED	Clear	Single

Note - LR008982 & LR008975 require additional wiring - LR009711. LR008913 require additional wiring - LR010368.



LR008975



LR009792

12v LED Flasher Unit

PRC8876LED

Upgrade the standard flasher unit to the LED version. Manual adjustment to correct flasher rate. Can be used with any combination of LEDs and halogen bulbs - with or without additional loads such as trailers.



facebook.com/britpart

Defender North American Specification (NAS) Lights

AMR6526	Stop/tail	Red	Single
AMR6527	Indicator	Amber	Single

Note - Supplied without mounting plinth and screws.

AMR6528	Reverse	Clear	Single
---------	---------	-------	--------

Note - Supplied with mounting plinth but without screws.

XFD500010	Reverse	Clear	Single
-----------	---------	-------	--------

XFE500010	Fog	Red	Single
-----------	-----	-----	--------

Note - Supplied with mounting plinth and screws.

Defender NAS LED lights

AMR6526LED	Stop/tail LED	Red	Single
AMR6527LED	Indicator LED	Amber	Single
AMR6526LEDCL	Stop/tail LED	Clear	Single
AMR6527LEDCL	Indicator LED	Clear	Single
XFD500010LED	Reverse LED	Clear	Single
XFE500010LED	Fog LED	Red	Single
XFE500010LEDCL	Fog LED	Clear	Single
DA1273	Front side LED	Clear	Single



AMR6527



AMR6527LEDCL

Sundry items

DA4349	ABS plastic NAS tail light guard	Single
AMR3850	Mounting plinth	Single

SE105161L	Screws	Pack of 10
-----------	--------	------------

STC1188	Link leads	
---------	------------	--

2 wire for indicator, side, reverse and fog lamp

STC4637	Link leads	
---------	------------	--

3 wire for stop and tail lamp

DA114412V	12 volt smart load device kit	
-----------	-------------------------------	--

DA114424V	24 volt smart load device kit	
-----------	-------------------------------	--

Note - To use the LED kit (DA1143) on a 24 volt Defender use DA114424V which replaces the 12 volt smart load device.

DA4349



Replacement Headlamps

Replacement headlamps for Series, Defender & Range Rover Classic

Crystal halogen headlamp

> Clear lenses and profiled back reflector offer brilliant lighting.

> Fully E-marked.

RTC4615C	Right hand drive - Britpart	Pair
----------	-----------------------------	------

RTC4615CW	Right hand drive - Wipac	Pair
-----------	--------------------------	------

PRC7994C	Left hand drive - Britpart	Pair
----------	----------------------------	------

Note - Bulbs not included

589783	Bulb - 60/55W H4	Single
--------	------------------	--------

Sealed beam to halogen headlamps with bulbs

RTC4615K	Right hand drive	Pair
----------	------------------	------

PRC7994K	Left hand drive	Pair
----------	-----------------	------

Wipac with bulbs

RTC4615KW	Right hand drive	Pair
-----------	------------------	------

RTC4615W	Right hand drive	Single
----------	------------------	--------

589783	Replacement bulb	
--------	------------------	--

589783	60/55W H4	Single
--------	-----------	--------



LED Interior Festoon Bulbs



- > Premium 12V 6000K
- > Ideal for upgrading interior bulbs
- > LEDs produce around 200 lumens and a 6000K colour temperature
- > They will last roughly 5 times longer than a standard bulb
- > 2 watts

586438LED NEW

Defender - 1987 onwards/Discovery 1/Discovery 2

Freelander 1/Range Rover Classic - 1986 - 1994

Range Rover P38

CZQ000010LED NEW

Range Rover L322

RTC3633LED NEW

Discovery 1/Discovery 2/Freelander 1/

Range Rover Classic - 1992 - 1994/

Range Rover P38

Heater Control Light Upgrade Kit Clear Lights



JFC102550B
Restore the Range Rover P38's heater control unit back to full brightness with this Britpart kit. Full fitting instructions are included.



XBD100760W
Freshen up the look of your Discovery 1 with a set of these clear lens lights. Bulbs included.

AMR6510W Rear bumper lamp assembly Right
AMR6509W Rear bumper lamp assembly Left
XBD100760W Front indicator Right
XBD100770W Front indicator Left

Xenon Headlamp Bulbs



DA5052	Ultima	H1 fitment	Pair
DA5016	Ultima	H4 fitment	Pair
DA5016-130	Xenon 130	H4 fitment	Pair
DA5024	Ultima	H7 fitment	Pair
DA5024-130	Xenon 130	H7 fitment	Pair
DA5053	Ultima	H11 fitment	Pair
DA5053-130	Xenon 130	H11 fitment	Pair

- > Ultima - up to 120% more light on the road.
- > Xenon 130 - up to 130% more light on the road.
- > 100% Xenon gas and advanced filament technology produce exceptional night driving performance.
- > A longer beam pattern enables other road users to be seen more clearly and allows more time to react to potential hazards.
- > Better reflections from road markings and signs make for more comfortable and safer night driving.
- > Street legal and a simple upgrade from standard bulbs, requiring no changes to vehicle wiring.

Xenon Ultima Headlamp Upgrade



DA5014
Xenon 7" universal fit headlamp upgrade kit includes Xenon Ultima. Suitable for Defenders, Series and Range Rover Classic. Xenon Ultima is the first auto bulb to put 120% more light on the road. The lamps have a complex surface to give a superior light distribution. They are E-approved, fully road legal and the kit includes headlamp units and xenon bulbs. 3 year warranty.

DA5014	Right hand drive	Pair
DA5015	Left hand drive	Pair
DA5016	H4 replacement headlight bulbs for DA5014 & DA5015	Pair

Spare Light Bulb Kits



DA5018 H1 kit **DA5019** H4 kit



DA5020 H7 kit **DA5021** H7/H11 kit

Britpart Lynx Eye LED Headlamps



DA6282 Right hand drive pair
DA6283 Left hand drive pair
 Standard 7" fitment for Defender, Series & Range Rover Classic. Durable polycarbonate lens & die-cast aluminium housing provide maximum protection

Features & Benefits

- Light source - 8pcs CREE(XML-10W) LED
- > Certification - DOT & E-mark.
- > 2800LM@30W on low beam.
- > 4450LM@48W on high beam.
- > Stepless thermal management system built-in.
- > Durable polycarbonate lens stands up to harsh environmental conditions.
- > Rugged solid LED means never having to replace another bulb again.
- > Die-cast aluminium housing provides maximum protection.



General Specifications

- > Lens material: Polycarbonate
- > Housing material: Die-cast aluminium
- > Mounting: Replaces PAR56 headlights
- > Mounting connector: H4 and H4 to H13 converter
- > Colour temperature: 6000-6500K

Technical Specifications

- > Low beam: 2.5 amps @12V DC
- > High beam: 2.00 amps @ 24V DC
- > Low beam: 1.25 amps @ 24V DC
- > Row lumen output: 5600LM
- > Effective lumen output: 3640LM

Note - Some EU countries may require fitment of headlamp washers.

ECE LED Headlamps



DA6280K Right hand drive Pair
DA6281K Left hand drive Pair

Series/Defender/Range Rover Classic

Technical Specifications

- > Hard-coated polycarbonate lens.
- > eCoat aluminium housing and internal structures.
- > Metallized reflector.
- > 1.3mm CSA / 16 gauge wire.
- > Light source - 2 LED arrays.
- > Multi-volt (9V-33V) design works with both 12V and 24V systems.
- > More technical information available online.

Note - Some EU countries may require fitment of headlamp washers.

Features & Benefits

- > ECE & ROHS compliant.
- > LED sealed beam technology with polycarbonate lens and sealed electronics.
- > Up to 50 x longer life than halogen headlamps, lowering life-cycle costs.
- > Produces pure white light, nearly identical to daylight that is easy on the eye, unlike harsh blue HID systems.
- > Includes built-in position lamp with optional wiring.
- > Offers great forward vision, improved roadside coverage and highly controlled beam patterns, offering glare protection to oncoming traffic.
- > Dipped/passing beam and main/driving beam functionality.
- > Ultra-bright output for maximum night visibility.
- > H4, 3-Blade connector system (main & dipped beam only).

LED Light Bars

DA6284



DA6284
500mm LED light bar - single
Size - including bracket
H 98mm x W 574mm x D 91mm
Function - Combination beam
Watts - 90W
Light source - 30 x 3W LED
Light output - 7,500 Lumens

DA6295



DA6295
120mm LED light bar - single
Size - including bracket
H 98mm x W 174mm x D 91mm
Function - Spot beam
Watts - 18W
Light source - 6 x 3W LED
Light output - 1,500 Lumens

- > Housing - aluminium extrusion with black electrophoretic coating.
- > Bracket - adjustable heavy-duty stainless steel.
- > Lens - Clear polycarbonate.
- > ECE Approved.
- > Long life/Low power
- > Dual voltage - 12/24V
- > Waterproof rating - IP67



Light Mountings

DA5624



DA5624
Defender - non-air-con Black
Note - Light bar excludes lights



STC50243



STC50243
Discovery 2 Black



Note - Light bar excludes lights DA4088

Light Mounting Kits

Replacement plastic bowls for standard 7" headlight mountings on Defenders & Series.

DA3010	7" Headlamp	Single with chrome bezel
DA3010B	7" Headlamp	Single with black bezel
DA1158	7" Headlamp fixing kit - less bowl	Single Black bezel
STC3018SS	7" Headlamp mounting bezel	Single Stainless steel



Work Lights

Exterior Lights



DA1146
3 watt LED exterior work light with smart matt black aluminium housing. Input voltage 10-30 volts. Waterproof to IP67 standards. 85mm diameter with mounting bracket. Incredibly bright and in most cases will not require a relay due to the 3 watt load.

Verdict
"Robust and gives a useful spread of light."
Neil Watterson, LRO Deputy Editor



DA5075 NEW
12V, 55W
H3 Halogen bulb



DA4120
Hella Torero 5760 Work Light Long-range illumination H3 work light with handle. Includes universal mount (swivel) with M10 mounting screw for upright or pendant mounting. Prism optics for long-range illumination. The housing is made of black plastic, with a prominent edge to protect the lens. The reflector of steel sheet is bonded to the glass lens. With switch, vibration damper and guard.

- > Rated voltage: 12/24 volts
- > Recommended inclination angle: 15° - 20°
- > Range: 40m
- > Light exit diameter: 120mm
- > Diameter: 152mm
- > Overall height: 239mm
- > Protection: IP5K4K
- > Suitable bulb: H3 (Halogen) not included
- Part no. 12v - 606178



DA5073 NEW
Dual voltage round switched worklamp

- > Dual voltage
- > H3 bulb fitment
- > Bulb not included - DA5075
- > Wide flood light output
- > Clear polycarbonate lens
- > Impact and heat resistant polypropylene housing
- > Protected switch
- > Heavy duty zinc plated bracket

Product dimensions (mm) -
Height - 253 x Width - 168 x Depth - 119
Weight - 0.772kg
Voltage - 12/24V DC
Watts - 55/70W
Cap type - PK22s



DA5074 NEW
Dual voltage rectangular switched worklamp

- > Dual voltage
- > H3 bulb fitment
- > Bulb not included - DA5075
- > Handle for repositioning lamp, can be rotated through 270° and angled through 90°.
- > Clear polycarbonate lens
- > Impact and heat resistant polypropylene housing.
- > Protected switch
- > Heavy duty zinc plated bracket

Product dimensions (mm) -
Height - 239 x Width - 176 x Depth - 91
Weight - 0.658kg
Voltage - 12/24V DC
Watts - 55/70W
Cap type - PK22s

Inspection Lamps



DA5063

- High Power Mechanics Headlamp
- > 3W Cree LED provides 320 lumens of light output.
 - > Operating times: 2.5hrs (high); 8hrs (med) & 18hrs (low).
 - > Lamp adjusts through 50° to focus on work area.
 - > Tough & robust impact resistant aluminium construction, ideal for a workshop environment.
 - > Weatherproof design for outdoor use.
 - > Adjustable headstrap with padding for comfortable usage.
 - > 4 x AAA batteries included.



DA5026

- Professional LED Inspection Pocket Lamp
- > Rechargeable and cordless for convenient use.
 - > High powered LEDs provides a bright light output.
 - > Anti-slip comfortable grip.
 - > Magnet for hands free use.
 - > LED torch function for focused light output.
 - > Precision reflector provides wide angle light output.
 - > Tough and robust polycarbonate lens for demanding conditions.
 - > Lithium ion battery for faster consistent recharging.
 - > Includes AC mains charging adapter with UK plug.

Specifications

Light output: 120 lumens
 Battery: 3.7v 1200mAh
 Mains adapter: Input 240v - 50/60Hz
 Output 5v - 300mA
 Operating time: 5hrs
 Charging time: 5hrs



DA5027

- Essential LED Inspection Pocket Lamp
- > Magnet for hands free use.
 - > LED torch function for focused light output.
 - > Protective lens for demanding conditions.
 - > Integral swivel pocket clip.
 - > Includes batteries.

Specifications

Battery: 3 x AAA
 Operating time: 5hrs



Add some light to your working environment.



DA5066 / DA5067

MAGflexTwist Ultra Bright LED Inspection Lamp

DA5066

UK plug

DA5067 NEW

EU plug

- > Rechargeable and cordless.
- > New technology COB LED provides 250 lumens light output.
- > Lamp can rotate 360° with a 180° ratcheting design to allow ultimate directional lighting.
- > White light output simulates daylight.
- > Wide angle of light output that has uniform intensity.
- > Magnet for hands free use.
- > Integral hanging hook.
- > High power LED torch function.
- > Anti slip comfortable grip.
- > Li-ion battery for faster consistent recharging.
- > Includes AC mains charger and 12v DC charging lead.

Light output: 250 lumens
 Battery: 3.7v Li-ion 2200mAh
 8.14Wh
 Mains adaptor: Input 230v AC-50/60Hz
 Output 5v DC-500mA

DA5065

LED Under Bonnet Inspection Lamp

- > 3 x 5W LEDs provide 1,000 lumens light output.
- > Long operating time allows full working day usage.
- > 3 levels of light output.
- > 6000K colour temperature for bright white light.
- > 40° adjustable head to shine light on the engine bay exactly where it is required.
- > 60° wide angle illumination.
- > Sturdy polycarbonate, ABS and aluminium construction.
- > Rechargeable 3.7V 10,400mAh li-ion battery.
- > Hook design allows usage with different vehicle types including, cars, vans and 4x4s.
- > Illuminated battery status indicator.
- > Includes AC mains adaptor.

Light output: 1000 lumens (3 lamps)
 675 lumens (2 lamps)
 350 lumens (2 lamps)
 Operating time: 6 hours (3 lamps)
 10 hours (2 lamps)
 15 hours (1 lamp)
 Battery: 3.7V Li-ion
 10400mAh
 38.48Wh
 Main adaptor: Input: 230V AC 50/60Hz
 Output: 5V DC 2000mA

DA5065



Photo courtesy of James Harding



MONDAY	TUESDAY	WEDNESDAY	THURSDAY	FRIDAY	SATURDAY	SUNDAY
						1st
2nd	3rd	4th	5th	6th	7th	8th
9th	10th	11th	12th	13th	14th	15th
16th	17th	18th	19th	20th	21st	22nd
23rd	24th	25th	26th	27th	28th	29th
30th	31st					

BRITPART

The quality parts for Land Rovers

JANUARY 2017

Winter Warrior

Land Rover L34 - Black Package
Winning, Cornwall, UK
by Mark Rowley

Make Your Land Rover A Star in 2018!

Here at Britpart we are planning our next Land Rover themed calendar and we'd love to feature the pictures of proud Land Rovers owner's vehicles – whatever model, age or condition of the vehicle.

We love to see pictures of Land Rovers in locations stretching from rural UK, right through to vehicles in a foreign urban environment - use your imagination. Winning entries will all feature in the next Britpart calendar and each one picked will win a great prize. So get out there with your Land Rover and camera - happy snapping. You can send us as many entries as you would like! **Good luck!**

Prizes

There will be 12 prizes awarded –

1 x first prize: £250 cash prize, 10 copies of the calendar with the winning image on the front cover and featured inside the calendar and a large Britpart hamper.

11 x second prizes: 5 copies of the calendar and a Britpart hamper.

Details on how to enter and full terms and conditions - www.britpart.com/calendar

Towing

This section contains all of the equipment needed to get you hitched up and towing with a wide selection of hitches and ancillary parts to suit all Land Rover models!

All Models	56
Defender	57
Discovery	58 - 59
Freelander	60
Range Rover	61 - 62
Series	60



All Models

Towing Hitches



201691



DA5100



KNB100640



- 201691** Ball, jaw & pin - heavy-duty
4 bolt mounted
(ball 3½ ton/jaw 5 ton)
- DA2123** Ball, jaw & pin
(RTC8159/LR008244)
- DA5100** Tow hitch (3½ ton)
- KNB100640** Towing jaw (3½ ton)
- NRC2051** NATO Tow hitch

NRC2051



Photo courtesy of Joel Forte

Ancillary Parts

- 67187** Pin universal coupling - heavy-duty (201691)
- DA2194** Replacement pin for DA2123
- DA2196** Replacement slider pin
- DA2197** Replacement slider pin 'R Clip'
- DA2123A** Replacement chain, tag & clip
- ANR3635** 50mm Tow ball cover
- 579408** 7-pin trailer plug
- DA5023** 7-pin to 13-pin adaptor
To use on vehicles with 7-pin towing electric sockets
- DA5025** 13-pin to 2 x 7-pin adaptor - 12N/12S
Ideal for when vehicles with a 13-pin socket are required to tow caravan/trailer with twin 7-pin plugs.
- DA1126** Universal towing electrics
12N Rear audible relay kit with pre-wired 2m cable

- RTC8872** 12N 8-Core single socket assembly with audible relay & fog cut out
- > 12N 7 pin socket suitable for connection to trailers with a 12N plug.
- > Pre-wired with 2 metres of 12N cable and mounted on a mounting plate for quick and easy fitment to the towing vehicle.
- > Includes an 8th connection for use as a fog-cut-out facility when towing a caravan.
- > Comes complete with audible sensor relay (RCT380), rubber grommet and connectors.

- DA1342 NEW** 1.5" towball spacer block kit
- DA2195** Replacement slider bracket - 1-pin
- DA2118** Replacement slider bracket - 2-pin
- RTC8831** Saddle slider - fits all Dixon Bates kits



67187



DA2194



DA2196

DA2197



DA2123A



ANR3635



579408



DA5023



DA5025



DA1126



RTC8872



DA1342



DA2195



DA2118



RTC8831

Defender

Towing Hitches



STC50269AA / STC50301



242139



LR007221 / DA2123

DA2121	Defender 90/110 - up to WA	Adjustable kit (RTC8828AA)
DA2136	Defender 90 - XA onwards	Towbar assembly (VUB105460) - no electrics
DA2137	Defender 110 - XA onwards	Towbar assembly (VUB105470) - no electrics
LR007221	Defender 90 - Td5 & 2007 onwards	Adjustable tow kit
LR007222	Defender 110 - Td5 & 2007 onwards	Adjustable tow kit
LR007223	Defender 110/130 - 1998 onwards	High-Cap pickup adjustable tow kit (STC50257AB)
STC50269AA	Defender 90 - XA onwards	Rear step - includes regulation tow bracket
STC50301	Defender 110 - XA onwards	Rear step - includes regulation tow bracket
VPLDT0086	Defender 110 - High-Cap pickup - 2007 onwards	Multi-height tow bar with tow ball
242139	Defender - all models	Front towing eye
RTC8891AA	Defender - all models	50mm Tow ball. 3.5 ton EU approved.

RTC8891AA



DA2121



DA2136



DA2137



LR007222



Photo courtesy of James Hutchinson

LR007223



VPLDT0086



Britpart have all the equipment to get you hitched up and towing.

Ancillary Parts

LR005919	Defender - 2007 onwards - all models	13-pin socket electrics kit
LR005920	Defender - 2007 onwards - all models	'N' Type electrics kit
LR005921	Defender - 2007 onwards - all models	'S' Type electrics kit - front
STC4286	Defender - all models	12N 7-pin socket
YWJ101500	Defender - Td5	'N' Type electrics plug



LR005920



LR005921

STC4286



LR005919



YWJ101500



Discovery

Towing Hitches



DA2134	Discovery 1 - up to 1994 Includes electrics (not plug-in) (STC8816)	Tow kit
DA2125	Discovery 1 - 1994 onwards (RTC8830, STC8060)	Adjustable coupling
RTC8891AA	Discovery 1	50mm Tow ball
DA2138	Discovery 2 Includes electrics (not plug-in), excludes tow ball	Towing kit
STC50287AB	Discovery 2 No electrics	Tow kit - coil suspension
STC50289AB	Discovery 2 No electrics	Tow kit - air suspension
STC50319	Discovery 2 None sliding adjuster - no electrics	Multi-height tow kit
KNB500070 LR071295	Discovery 3 / Discovery 4 Quick disconnect without height adjustment Less Canada, Mexico & USA	Towing hook assembly
KNW500020	Discovery 3 / Discovery 4	Replacement lock for KNB500070 & LR071295
LR007484	Discovery 3 Less Canada, Mexico & USA	Adjustable tow hook kit
LR007484G	Discovery 3 Less Canada, Mexico & USA	Adjustable tow hook kit
LR041041	Discovery 4 Less Canada, Mexico & USA	Adjustable tow hook kit
LR041041G LR070497G NEW	Discovery 4 Less Canada, Mexico & USA	Adjustable tow hook kit
VPLRT0171LR NEW VPLRT0175LR NEW	All-New Discovery All-New Discovery	Detachable tow bracket Fixed multi-height tow bracket
VPLCT0140LR	Discovery Sport 5-seat / 7-seat (less spare wheel)	Kit tow bar – flange ball
VPLCT0142	Discovery Sport 7-seat (with spare wheel)	Kit tow bar – flange ball
VPLCT0143	Discovery Sport 7-seat (with spare wheel)	Kit tow bar – swan neck
VPLCT0147	Discovery Sport 5-seat / 7-seat (less spare wheel)	Kit tow bar – quick release
VPLCT0148	Discovery Sport 7-seat (with spare wheel)	Kit tow bar – quick release
LR061295LR	Discovery Sport	Bumper cover



Photo courtesy of Louise Thompson

Discovery

Ancillary Parts

STC4286



STC8875



YWT10002L



STC50081



STC50181



STC50389



STC8919AA



DA2602



STC4286	Discovery 1	12N 7-pin socket
STC8875	Discovery 1 - MA081881 onwards	12S socket
YWT10002L	Discovery 1	Electronic flasher unit for towing
STC50081	Discovery 2	'N' Type electrics socket
STC50181	Discovery 2	'N' Type electrics socket - less front fog lamps
STC50389	Discovery 2	Socket - split charge 'S' type post 1999 caravan
STC8919AA	Discovery 3	Tow strap
DA2602	Discovery 3	Tow bar electrics kit - 13-pin (YWJ500160) Plug in electrics
YWJ500201	Discovery 3	Tow bar electrics kit 'N' & 'S' type For Great Britain & Ireland
VPLAT0011	Discovery 4	12N/12S 7-pin electric socket
VPLCT0244 NEW	Discovery Sport	Tow bar electrics - 13-pin 7-seats with spare wheel
VPLCT0182	Discovery Sport	Tow bar electrics - 13-pin 7-seats without spare wheel/5-seats
DA1325	Discovery Sport	Tow bar electrics - 7-pin
DA1326	Discovery Sport	Tow bar electrics - 13-pin

YWJ500201



VPLAT0011



VPLCT0244



VPLCT0182



DA1325



DA1326



Sign up to the regular Britpart newsletter to find out about all the latest product releases. www.britpart.com/newsletter



Photo courtesy of Jundío Salvador

Freelander

Towing Hitches

KNK500060



KNK500070



STC50391



KNK500080



VPLFT0120



VPLFT0118



VPLFT0119



facebook.com/britpart

- KNK500060** Freelander 1 Tow bracket kit - European style fixed swan neck
- KNK500070** Freelander 1 Tow bracket kit - UK style 50mm ball fitted (VUB501490)
Note - This has a plug connection to the vehicle loom - with electrics
- STC50391** Freelander 1 Tow bracket kit
Includes electrics but not plug-in electrics or tow ball
- KNK500080** Freelander 1 Tow bracket kit - swan neck detachable
With plug-in electrics

- VPLFT0120** Freelander 2 - DH000001 onwards Tow bracket kit - swan neck
- VPLFT0118** Freelander 2 Tow bracket kit
- VPLFT0119** Freelander 2 Tow bracket kit - detachable ball tow bar
Excluding body styling kit

Ancillary Parts

- STC50459** Freelander 1 Electrical assembly kit
12S pre-1999 caravan auxiliary electrics
- STC50460** Freelander 1 Electrical assembly kit
12S post-1999 caravan auxiliary electrics
- YMZ101030** Freelander 1 Electrical assembly kit - 7-pin 12N lighting
- YWJ500070** Freelander 1 Electrical assembly kit
13-pin auxiliary electrics
- YWT10002L** Freelander 1 Electronic flasher unit for towing
- VPLFT0001** Freelander 2 - up to DH Electrical assembly kit
12N/12S 7-pin socket (LR003106)
- VPLFT0105** Freelander 2 - DH onwards Electrical assembly kit
12N/12S 7-pin socket
- VPLFT0077** Freelander 2 CH000001 - CH999999 Electrical assembly kit - 13-pin socket
- VPLFT0106** Freelander 2 - DH onwards Electrical assembly kit - 13-pin socket

- STC50459** Freelander 1 Electrical assembly kit
12S pre-1999 caravan auxiliary electrics
- STC50460** Freelander 1 Electrical assembly kit
12S post-1999 caravan auxiliary electrics
- YMZ101030** Freelander 1 Electrical assembly kit - 7-pin 12N lighting
- YWJ500070** Freelander 1 Electrical assembly kit
13-pin auxiliary electrics
- YWT10002L** Freelander 1 Electronic flasher unit for towing
- VPLFT0001** Freelander 2 - up to DH Electrical assembly kit
12N/12S 7-pin socket (LR003106)
- VPLFT0105** Freelander 2 - DH onwards Electrical assembly kit
12N/12S 7-pin socket
- VPLFT0077** Freelander 2 CH000001 - CH999999 Electrical assembly kit - 13-pin socket
- VPLFT0106** Freelander 2 - DH onwards Electrical assembly kit - 13-pin socket

YMZ101030



YWJ500070



YWT10002L



VPLFT0001



VPLFT0105



VPLFT0077



VPLFT0106



Series

Towing Hitches

- 242139** Series - all models Front towing eye
- DA2122** Series - all models Adjustable tow hitch kit
- RTC8891AA** Series - all models 50mm Tow ball
- DA2129** Lightweight Adjustable tow hitch kit

242139



DA2122



RTC8891AA



DA2129



Ancillary Parts

- DA2012** Series - SWB Drop plate - standard
- DA2133** Series - all models Drop plate - extended

DA2012



DA2133



Range Rover

Towing Hitches



DA2125	Range Rover Classic	Adjustable coupling (RTC8830/STC8060)
DA2134	Range Rover Classic	Tow kit (STC8816) up to 1994
	Range Rover P38	Tow kit
DA4030		Note - No tow ball included. It is not a Swan neck type, a standard 50mm tow ball is required (RTC8891AA). Electrics are included but not plug-in.
KNB500070 LR071295	Range Rover Sport - 2005 - 2013 Less Canada, Mexico, USA & Australia	Towing hook assembly Quick disconnect without height adjustment
KNW500020	Range Rover Sport - 2005 - 2013	Replacement lock for KNB500070 & LR071295
LR007484	Range Rover Sport - 2005 - 2009 Less Canada, Mexico & USA	Adjustable tow hook kit
LR007484G	Range Rover Sport - 2005 - 2009 Less Canada, Mexico & USA	Adjustable tow hook kit
LR041041	Range Rover Sport - 2010 - 2013 Less Canada, Mexico & USA	Adjustable tow hook kit
LR041041G	Range Rover Sport - 2010 - 2013 Less Canada, Mexico & USA	Adjustable tow hook kit
VPLWT0159	Range Rover Sport - 2014 onwards	Fixed multi-height tow bracket kit
DA5030	Range Rover L322	Towbar/flange towball - equivalent to VUB000740 & VUB000720
VUB000740	Range Rover L322 Up to 2006 Europe model	Tow bar armature - towing subframe
		Note - The tow bar armature accepts quick release, multi-height tow bars and bike carrier
VUB000720	Range Rover L322 - inc. 2010 onwards Less Canada, Mexico & USA	Multi-height tow bar Includes carry bag
VUB000730	Range Rover L322 - inc. 2010 onwards Less Canada, Mexico & USA	Quick release tow bar
VUB503960	Range Rover L322 - inc. 2010 onwards Towing subframe - 6A000001 onwards	Tow bar armature
VPLGT0082	Range Rover L405	Tow kit bracket - swan neck fixed
VPLVT0065	Range Rover Evoque	Tow kit bracket - swan neck fixed
VPLVT0069	Range Rover Evoque	Tow kit bracket - quick release tow bar
VPLVT0078	Range Rover Evoque	Tow kit bracket - flange ball



Range Rover

Ancillary Parts

YWT10002L



DA2602



YWJ500150



VPLST0014



VPLWT0114



STC8919AA



VUH000020



YWC000840



YWJ500450



YWJ500460



VPLGT0073



VPLHT0061



VPLHT0062



YWT10002L	Range Rover Classic - 1992 - 1994	Electronic flasher unit for towing
DA2602	Range Rover Sport - 2005 - 2009	Tow bar electrics kit 13-pin (YWJ500160) Plug in electrics
YWJ500150	Range Rover Sport - 2005 - 2009 Less Canada, Mexico, USA	Tow bar electrics kit 12'N' & 12'S' type - 7-pin
VPLST0014 NEW	Range Rover Sport - 2010 - 2013 Less Canada, Mexico, USA	Tow bar electrics kit 12'N' & 12'S' type - 7-pin
VPLWT0114	Range Rover Sport - 2014 onwards	Tow bar electrics kit 13-pin
STC8919AA	Range Rover Sport - 2005 - 2013 & 2014 onwards	Tow strap
VUH000020	Range Rover L322 - up to 2006	Towing electrics with 13-pin socket, harness & control unit module (YWC000840)
YWC000840	Range Rover L322	Towing electrics control unit module
YWJ500450	Range Rover L322 - 6A000001 onwards Less Canada, Mexico & USA	Tow bar electrics kit 12'N' & 12'S' type - 7-pin
YWJ500460	Range Rover L322 - 6A000001 - up to 2009 Less Canada, Mexico & USA	Tow bar electric 13-pin socket & harness
STC8919AA	Range Rover L322	Tow strap
VPLGT0073	Range Rover L405 Less Canada, Mexico, USA & Australia	Tow bar electrics 13-pin socket & harness
VPLHT0061	Range Rover Evoque Less Canada, Mexico, USA & Australia	Tow bar electrics - 13-pin
VPLHT0062	Range Rover Evoque Canada, Mexico, USA	Tow bar electrics



Photo courtesy of Pamela Blair

Interior Protection

Protect the inside of your Land Rover with our selection of dog guards, load space mats, carpets and seat covers. Keep your vehicle looking smart inside no matter what you have to throw in it!

Dog Guards-----64 - 65

Loadspace

Loadspace mats & protectors-----67 - 68
Loadspace nets & retention kits-----69
Loadspace protectors - premium-----66

Mats

Carpet-----70
Premium-----70
Rubber-----70 - 71

Waterproof Seat Covers

Britpart-----72 - 73
Other-----73



Dog Guards

DA4027 / RTC8095

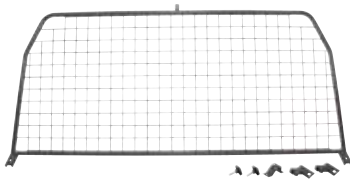

STC50479

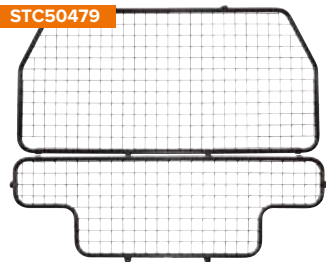

Defender/Series

DA4027 / RTC8095 Half height Mesh type Grey
 Defender 90/110 - 1987 - 2006 & 2007 onwards - hardtop with bulkhead
 Series - hardtop with bulkhead

STC50479 Full height Mesh type Grey
 Defender 90 - 1987 - 2006 - without bulkhead

STC7555 Full height - 1 piece Mesh type Grey
 Defender 110 - County Station Wagon - 1987 - 2006
 Defender 90/110 - Commercial with bulkhead removal bar fitted - 1987 - 2006

VUB500510LR Full height - 2 piece Mesh type Black
 Defender 110 - County Station Wagon - 1987 - 2006

DA5539 NEW Full height Mesh type Black
 Defender 110 - County Station Wagon & Utility - 2007 onwards without bulkhead

Discovery

STC8414 Discovery 1 Half height Mesh type Grey

STC50323 Discovery 2 Half height Mesh type Grey

DA5511A Discovery 3/Discovery 4 Half height Mesh type Black

VUB501170 Discovery 3/Discovery 4 Full height Mesh type Black

DA5809 NEW All-New Discovery (5) Half height Mesh type Black

VPLCS0300 Discovery Sport **NEW** Half height - cargo barrier Mesh type Black

DA5812 NEW Discovery Sport Full height Mesh type Black

Freelander

STC7939AB Freelander 1 Full height Bar & mesh type Grey

DA5801A Freelander 2 Half height Mesh type Grey

LR002521 Freelander 2 Full height/full width Mesh type Black

STC7555



VUB500510LR

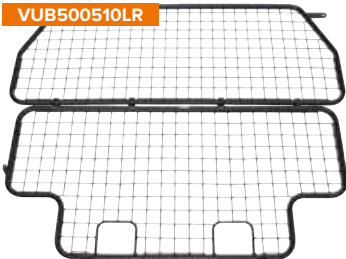

DA5539

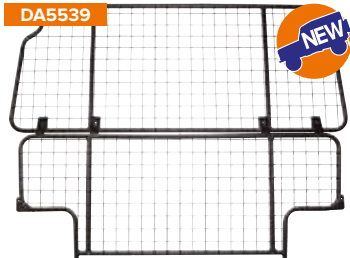

STC8414

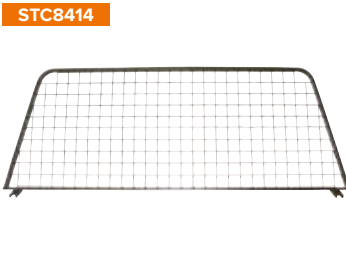

STC50323



DA5511A

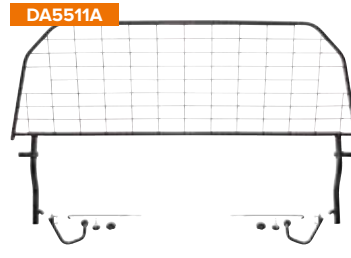

VUB501170



facebook.com/britpart

DA5809



DA5809

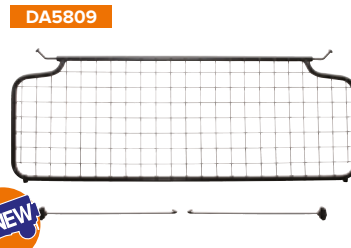

VPLCS0300



VPLCS0300



DA5812



STC7939AB



DA5801A



LR002521

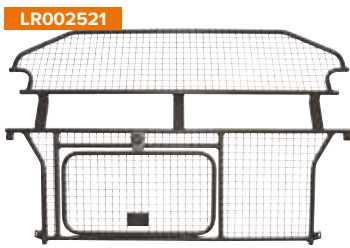

Photo courtesy of Richard Reid

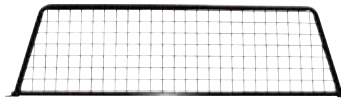

Photo courtesy of Ian Egerton

Range Rover

DA4141	Range Rover Classic - 1986 - 1994	Half height	Mesh type	Black
STC8524	Range Rover P38	Half height	Bar type	Grey
DA1081	Range Rover Sport - 2005 - 2013	Half height	Mesh type	Grey
DA1082	Range Rover Sport - 2005 - 2013		Mesh type	Grey
	Dog guard divider - use with DA1081			
DA5810	Range Rover Sport - 2014 - onwards	Half height	Mesh type	Black
DA5811	Range Rover Sport - 2014 - onwards		Mesh type	Grey
	Dog guard divider - use with DA5810			
VUB002120	Range Rover L322	Half height	Mesh type	Black
LR007320	Range Rover L322	Half height	Mesh type	Black
DA5806	Range Rover L405		Mesh type	Black
DA5807	Range Rover L405	Lower guard	Mesh type	Grey
	Can only be used in conjunction with DA5806			
DA5803	Range Rover Evoque - 5-door	Half height	Mesh type	Black
DA5805	Range Rover Evoque - 3-door	Half height	Mesh type	Black

DA4141



STC8524



For more images - www.britpart.com/dog

Keep Rover firmly in his place!

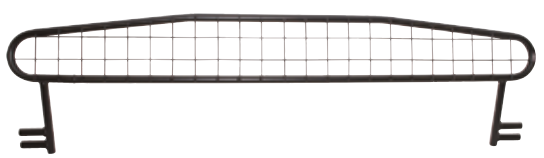
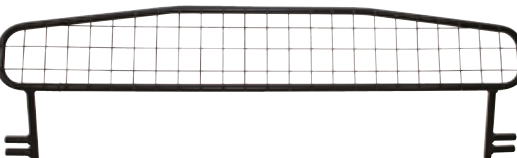

Fits in seconds, no drilling, no bolts.

Fits in seconds, no drilling, no bolts.



Photo courtesy of Jo Pritchard



Photo courtesy of Henry van Vliet

Loadspace

Loadspace Protectors - Premium



Premium semi-rigid loadspace protectors

DA4183	Discovery 1	3" deep sides
DA4169	Discovery 2	3" deep sides
DA5602	Discovery 3/Discovery 4	3" deep sides
DA4171	Freelander 1	2" deep sides
DA5554	Freelander 2	2" deep sides
DA4170	Range Rover P38	3" deep sides
DA5555	Range Rover Sport - 2005 - 2013	2" deep sides
DA5556	Range Rover L322 - all models	2" deep sides

Britpart's unique premium loadspace mats are manufactured from a high-specification material. Designed to be durable with an anti-slip, matt look finish. These quality protectors will look after your Land Rover's loadspace for years to come.



Premium loadspace protectors manufactured from semi-rigid foam with anti-slip finish and 2" deep sides.

DA4829	Discovery Sport	DA4825	Range Rover Sport - 2014 onwards
DA5557	Range Rover Evoque - 3 & 5 door models	DA4822	Range Rover L405



Photo courtesy of Alan Yim

Loadspace Mats & Protectors



Keep dirt at bay with a loadspace liner..



Sign up to the regular Britpart newsletter to find out about all the latest product releases. www.britpart.com/newsletter

Defender/Series

331401	Series SWB	Loadspace mat	1,177 x 920 x 3mm	Ribbed rubber
331670	Series LWB	Loadspace mat	1,560 x 920 x 3mm	Ribbed rubber
MTC8294	Defender 90	Loadspace mat	1,250 x 920 x 3mm	Ribbed rubber
DA4470	Defender 90	Loadspace mat	1,230 x 920 x 6mm	Moulded rubber
LR005615	Defender 90	Loadspace mat	1,230 x 890 x 6mm	Moulded rubber
EAH500530	Defender 90 Station Wagon - 2007 onwards - 4-seat configuration	Loadspace mat	1,240 x 920 x 3mm	Ribbed rubber
331670	Defender 110	Loadspace mat	1,560 x 920 x 3mm	Ribbed rubber
DA4503	Defender 110 - Hard top & truck cab	Loadspace mat	1,980 x 930 x 5mm with 6mm foam backing	Rubber
LR005613	Defender 110 - 2007 onwards - 5-seat configuration	Loadspace mat	1,230 x 890 x 6mm	Moulded rubber
LR005040	Defender 110 - 2007 onwards - 7-seat configuration	Loadspace mat	1,230 x 890 x 6mm	Moulded rubber
EAH500520	Defender 110 Station Wagon - 2007 onwards - 7-seat configuration	Loadspace mat	1,565 x 920 x 3mm	Ribbed rubber
EAH500540	Defender 110 Station Wagon - 2007 onwards - 5-seat configuration	Loadspace mat	1,565 x 920 x 3mm	Ribbed rubber



Photo courtesy of Kyriakos Achilleos



Freelander

STC50434	Freelander 1 - 3-door	Loadspace mat	Rubber
STC50435	Freelander 1 - 5-door	Loadspace mat	Rubber
LR002516	Freelander 2	Loadspace mat	Rubber
LR002424	Freelander 2	Loadspace protector	Semi-rigid with 3" deep sides
VPLFS0244	Freelander 2	Loadspace flexible protector	Note - Not shown but is similar to image VPLSS0016 - see Range Rover Sport

> Interior Protection

Loadspace Mats & Protectors - continued



Discovery	Discovery 2	Discovery 2	Discovery 2
STC50052AA	Discovery 2	Loadspace mat - half length	Rubber
STC50053AA	Discovery 2	Loadspace mat - full length	Rubber
STC50050	Discovery 2	Loadspace protector Note - Trim required for air-con models	Semi-rigid with 8" deep sides
LR006401	Discovery 3/Discovery 4	Loadspace mat - half length	Rubber
EBF500010	Discovery 3/Discovery 4	Loadspace protector	Semi-rigid with 6" deep sides
VPLAS0015	Discovery 3/Discovery 4	Loadspace flexible protector Note - Not shown but is similar to Range Rover image - VPLSS0016	Semi-rigid with 2½" deep sides
VPLRS0386LR NEW	All-New Discovery (5)	Loadspace protector	Rubber
VPLRS0373AAML NEW	All-New Discovery (5)	Loadspace mat - non-rear air-con - Espresso	Rubber
VPLRS0373PVJLR NEW	All-New Discovery (5)	Loadspace mat - non-rear air-con - Ebony	Rubber
VPLCS0279LR	Discovery Sport	Rubber mat – loading compartment	
VPLCS0273LR	Discovery Sport	Rubber mat – loading compartment extension	
VPLCS0268LR	Discovery Sport	Semi-rigid liner - loading compartment	Compatible with cargo barrier
VPLCS0274LR	Discovery Sport	Semi-rigid liner – loading compartment	Not compatible with cargo barrier

Keep dirt at bay with a loadspace liner...



Range Rover	Range Rover Sport - 2005 - 2013	Range Rover Sport - 2005 - 2013	Range Rover Sport - 2005 - 2013
VPLSS0043	Range Rover Sport - 2005 - 2013	Loadspace mat	Rubber
EBF500020	Range Rover Sport - 2005 - 2013	Loadspace protector	Semi-rigid with 4" deep sides
VPLSS0016	Range Rover Sport - 2005 - 2013	Loadspace flexible protector	
LR003894	Range Rover L322	Loadspace mat	Rubber
EBF000040	Range Rover L322	Loadspace protector	Semi-rigid with 6" deep sides
VPLGS0263	Range Rover L405	Loadspace protector	Semi-rigid with 2" deep sides
VPLGS0151	Range Rover L405	Loadspace mat	Rubber
DA5054 NEW	Range Rover L405	Loadspace mat	Rubber
VPLVS0091	Range Rover Evoque	Loadspace mat	Rubber
VPLVS0089	Range Rover Evoque	Loadspace protector	Semi-rigid with 2" deep sides
VPLVS0090	Range Rover Evoque	Loadspace flexible protector	

Note - Not shown but is similar to Range Rover image - VPLSS0016

Loadspace Nets & Retention Kits



VPLMS0302



LR017770



VPLCS0271

Umbrella not included

Loadspace Retention Kits

Restricts the movement of goods in the rear of the vehicle.

VPLMS0302

Range Rover L322

Contents - 1 x floor net & 2 x ratchet straps

VPLCS0269

Discovery 3/Discovery 4/Discovery Sport

Range Rover Sport - 2005 - 2013/Range Rover Evoque

Contents - 1 x floor net & 2 x ratchet straps

VPLVS0125

Range Rover Sport - 2010 - 2013/Range Rover Evoque

Contents - 1 x rear retention bars; 1 x side retention strap & 1 x storage case

Note - must be used in conjunction with loadspace luggage rails.

Loadspace Luggage Rails

VPLSS0138

VPLSS0138

Range Rover Sport - 2010 - 2013

VPLVS0102

Range Rover Evoque



Loadspace Nets

A convenient way of storing luggage.

LR017770 Range Rover L322 Contents - 2 x nets

VPLCS0271 Freelander 2/Discovery Sport

Range Rover Evoque Contents - 1 x net

Can be used in two positions within the loadspace

Umbrella Holder

A convenient way of storing your umbrella

VPLGS0153 Range Rover L405 Contents - 2 x holders

Ratchet Straps

Make sure your load is safely secured.

DA1267

2m - pair



DA1267



VPLGS0153

Umbrella not included



VPLVS0125



SVX style cargo tie down point

DA1170

Smart and easy to fit

Single



Photo courtesy of Louise Thompson

Mats

DA4022BLACK



Carpet Mat Sets

DA4023GREY



DA4022BLACK	Defender - all models - front only	Black
DA4023BLACK	Discovery 1	Black
DA4023BLUE	Discovery 1	Blue
DA4023GREY	Discovery 1	Grey

Note - Front and rear carpet sets with rubber backing.

Rubber Mat Sets

BTR7895



BTR7896



BTR7897



BTR7898



Heavy-duty Defender rubber mats with foam backing

Individual Mats

BTR7895	Defender - LT77 gearbox	Front floor left hand
BTR7896	Defender - LT77 gearbox	Front floor right hand
BTR7897	Defender - 1993 onwards	Front floor left hand
BTR7898	Defender - 1993 onwards	Front floor right hand

Mat Sets

DA4501	Defender - LT77 gearbox	Front right & left hand	Contains - BTR7895 & BTR7896
DA4502	Defender - 1993 onwards	Front right & left hand	Contains - BTR7897 & BTR7898
STC50172	Defender - from XA159807	Front right & left hand	No foam backing
LR005039	Defender - up to BA999999	Front right & left hand	No foam backing
VPLDS0147	Defender - from CA000001	Front right & left hand	No foam backing

Premium Mat Sets

LR002485



VPLRS0332PVJLR



LR045096



Carpet Mats with Rubber Backing

VPLFS0245PVJ	Freelander 2	Front & rear contour set	RHD	Ebony black
VPLFS0246PVJ	Freelander 2	Front & rear contour set	LHD	Ebony black
LR002485	Freelander 2	Front & rear contour set	RHD	Alpaca beige
LR002497	Freelander 2	Front & rear contour set	LHD	Alpaca beige
EAH500080PVJ	Discovery 3	Front & rear floor set	LHD	Ebony black
LR006433	Discovery 3	Front & rear contour set	LHD	Alpaca beige
VPLAS0023PVJ	Discovery 3/Discovery 4	Front & rear contour set	LHD	Ebony black
EAH500011LUP	Range Rover Sport - 2005 - 2013	Front & rear floor set	LHD	Aspen
LR006437	Range Rover Sport - 2008 - 2013	Front & rear contour set	LHD	Ebony black
EAH500011PVJ	Range Rover Sport - 2005 - 2013	Front & rear floor set	LHD	Ebony black
EAH500015SMS	Range Rover Sport - 2005 - 2013	Front & rear floor set	LHD	Alpaca beige
EAH000300JMN	Range Rover L322 - up to 6A	Front & rear contour set	RHD	Navy
EAH000310JMN	Range Rover L322 - up to 6A	Front & rear contour set	LHD	Navy
EAH000310LUP	Range Rover L322 - up to 6A	Front & rear contour set	LHD	Aspen
EAH000300PVA	Range Rover L322 - up to 6A	Front & rear contour set	RHD	Jet
EAH000300SUN	Range Rover L322 - up to 6A	Front & rear contour set	RHD	Sand
EAH500290LUP	Range Rover L322 - from 7A	Front & rear contour set	LHD	Aspen
EAH500290PVA	Range Rover L322 - from 7A	Front & rear contour set	LHD	Jet
EAH500290SUN	Range Rover L322 - from 7A	Front & rear contour set	LHD	Sand

Premium protection for your Land Rover...

Rubber Mats

VPLFS0233	Freelander 2	Front & rear contour set	RHD	Black
VPLFS0234	Freelander 2	Front & rear contour set	LHD	Black
LR006237	Discovery 3/Discovery 4	Front & rear contour set	RHD	Black
LR006238	Discovery 3/Discovery 4	Front & rear contour set	LHD	Black
EAH500100PMA	Discovery 3/Discovery 4	3rd row floor mat	N/A	Black
EAH500052PMA	Discovery 3	Front & rear floor set	RHD	Black
EAH500050PMA	Discovery 3	Front & rear floor set	LHD	Black
EAH500058PMA	Discovery 3	Front contour set	RHD	Black
EAH500057PMA	Discovery 3	Front contour set	LHD	Black
VPLRS0332AAMLR NEW	All-New Discovery (5)	Front & rear floor set	RHD	Espresso
VPLRS0332PVJLR NEW	All-New Discovery (5)	Front & rear floor set	RHD	Ebony
VPLRS0333AAMLR NEW	All-New Discovery (5)	Front & rear floor set	LHD	Espresso
VPLRS0333PVJLR NEW	All-New Discovery (5)	Front & rear floor set	LHD	Ebony
VPLCS0278LR	Discovery Sport	1st & 2nd row	RHD	Black
VPLCS0281LR	Discovery Sport	1st & 2nd row	LHD	Black
VPLCS0280LR	Discovery Sport	3rd row floor mat	N/A	Black
VPLAS0197	Range Rover Sport - 2005 - 2013	Front & rear contour set	RHD	Black
VPLAS0198	Range Rover Sport - 2005 - 2013	Front & rear contour set	LHD	Black
VPLSS0104	Range Rover Sport - 2005 - 2013	Front & rear floor set	RHD	Black
EAH500051PMA	Range Rover Sport - 2005 - 2013	Front & rear floor set	LHD	Black
EAH500320PMA	Range Rover L322	Front & rear contour set	RHD	Black
EAH500330PMA	Range Rover L322	Front & rear contour set	LHD	Black
EAH000261PMA	Range Rover L322	Front & rear floor set	RHD	Black
EAH000271PMA	Range Rover L322	Front & rear floor set	LHD	Black
LR045096	Range Rover Evoque	Front & rear contour set	RHD	Black
LR045097	Range Rover Evoque	Front & rear contour set	LHD	Black

Rubber Mats

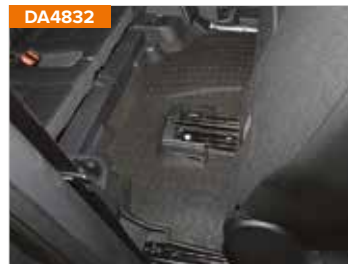
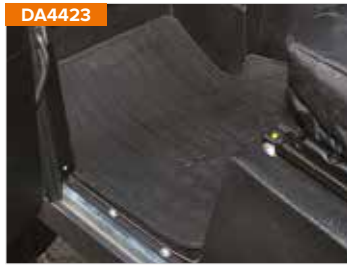

Quality fitted rubber over mats

DA4422	Series 2/Series 3	Front	Pair
DA4423	Defender - all models from XA159807	Front	Pair
LR005041	Defender - 110 - 2007 onwards - crew cab pick up	2nd row	Single
DA4426	Discovery 1	Front	Pair
DA4427	Discovery 1	Rear	Pair
DA4424	Discovery 2	Front	Pair
DA4425	Discovery 2	Rear	Pair
DA4802	Discovery 3/Discovery 4	RHD Front & Rear	Set
DA4803	Discovery 3/Discovery 4	LHD Front & Rear	Set
DA4819	Discovery 3/Discovery 4	3rd row contour floor mat	
DA4827	Discovery Sport	RHD Front & Rear	Set
DA4828	Discovery Sport	LHD Front & Rear	Set
DA4832	Discovery Sport	3rd row contour floor mat	
DA4428	Freelander 1	Front	Pair
DA4429	Freelander 1	Rear	Pair
DA4800	Freelander 2	RHD Front & Rear	Set
DA4801	Freelander 2	LHD Front & Rear	Set
DA4430	Range Rover P38	Front	Pair
DA4431	Range Rover P38	Rear	Pair
DA4804	Range Rover Sport - 2005 - 2013	RHD Front & Rear	Set
DA4805	Range Rover Sport - 2005 - 2013	LHD Front & Rear	Set
DA4823	Range Rover Sport - 2014 onwards	RHD Front & Rear	Set
DA4824	Range Rover Sport - 2014 onwards	LHD Front & Rear	Set
DA4806	Range Rover L322 - up to 6A999999	RHD Front & Rear	Set
DA4807	Range Rover L322 - up to 6A999999	LHD Front & Rear	Set
DA4808	Range Rover L322 - 7A000001 onwards	RHD Front & Rear	Set
DA4809	Range Rover L322 - 7A000001 onwards	LHD Front & Rear	Set
DA4820	Range Rover L405 - 2013 onwards	RHD Front & Rear	Set
DA4821	Range Rover L405 - 2013 onwards	LHD Front & Rear	Set
DA4812	Range Rover Evoque - 2 & 4 door	RHD Front & Rear	Set
DA4813	Range Rover Evoque - 2 & 4 door	LHD Front & Rear	Set

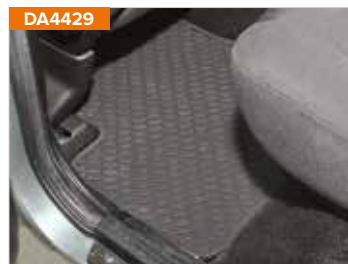

For more mat images -
www.britpart.com/mats

Keep your Land Rover interior clean with a set of Britpart fitted rubber mats.

Waterproof Seat Covers

Britpart Seat Covers

Colour swatches for illustrative purposes only.



Model	BLACK	BLUE	GREEN	GREY	SAND
Defender					
Defender - up to 2007 - 3 Seats - Front Covers in kit - 3 x full seat (excludes headrest covers)	DA2815BLACK	DA2815BLUE	DA2815GREEN	DA2815GREY	
Defender - 2007 onwards - Front Covers in kit - 2 x full seat; 2 x headrest	DA2818BLACK			DA2818GREY	DA2818SAND
Defender 110 Station Wagon - up to 2007 - Forward facing 2nd row - 60/40 Covers in kit - 1 x twin seat back & base & 1 x single seat back & base. Note - Will fit 110 Crew Cab with minor modification to seat covers.	DA2816BLACK			DA2816GREY	
Defender 110 Station Wagon - up to 2007 - Rear inward facing bench Covers in kit - 2 x bench-seat back & base. Note - For 1,200mm long seat.				DA2817GREY	
Defender 90/110 - 2007 onwards - Rear 2nd row forward facing Covers in kit - 2 x full seat; 2 x headrest	DA2838BLACK				
Defender 110/130 - 2007 onwards - Rear 2nd row forward facing - 60/40 split Covers in kit - 1 x twin seat back & base & 1 x single seat back & base	DA2828BLACK				
Discovery					
Discovery 1 - Front Covers in kit - 2 x full seat. Note - Discovery 1 seat covers will not fit vehicles with leather seats and 200Tdi's with pocket on rear seat.	DA2807BLACK	DA2807BLUE	DA2807GREEN	DA2807GREY	DA2807SAND
Discovery 1 - Rear Covers in kit - 1 x two-seat back & base; 1 x one-seat back & base. Note - Discovery 1 seat covers will not fit vehicles with leather seats and 200Tdi's with pocket on rear seat.	DA2808BLACK	DA2808BLUE	DA2808GREEN	DA2808GREY	DA2808SAND
Discovery 1 - Boot Covers in kit - 2 x full seat. Note - Discovery 1 seat covers will not fit vehicles with leather seats and 200Tdi's with pocket on rear seat.		DA2809BLUE	DA2809GREEN	DA2809GREY	
Discovery 2 - Front Covers in kit - 2 x full seat; 2 x headrest; 2 x armrest.	DA2800BLACK	DA2800BLUE	DA2800GREEN	DA2800GREY	DA2800SAND
Discovery 2 - Rear Covers in kit - 1 x full seat; 1 x two-seat back & base; 1 x armrest; 3 x headrest	DA2801BLACK	DA2801BLUE	DA2801GREEN	DA2801GREY	DA2801SAND
Discovery 2 - Boot Covers in kit - 2 x full seat; 2 x roof headrest.			DA2802GREEN	DA2802GREY	
Discovery 3 - Front Covers in kit - 2 x full seat; 2 x headrest; 2 x armrest. Note - Suitable for vehicles with side airbags.	DA2822BLACK				DA2822SAND
Discovery 3 - Rear - 35/30/35 split Covers in kit - 3 x full seat; 3 x headrests.	DA2823BLACK				DA2823SAND
Discovery 4 - Front Covers in kit - 2 x full seat; 2 x headrest; 2 x armrest. Note - Suitable for vehicles with side airbags.	DA2832BLACK				



A fantastic way to protect your Land Rover seats with these Britpart waterproof covers.

- > An extensive range of quality and stylish waterproof seat cover sets.
- > Front and rear sets available with headrests and armrests included in the Range Rover and Freelander range.
- > Rear inward facing sets are also available for the 7-seater Discovery models.
- > The hard-wearing washable covers are made from waterproof woven polyester with a PVC backing.
- > Snug fit covers available in stylish colours.
- > Easy to put on the seats and just as easy to remove again.

Britpart Seat Covers - continued

Colour swatches for illustrative purposes only.



Freelander				
Freelander 1 - 3 Door - Front	DA2810BLACK		DA2810GREY	
Covers in kit - 2 x back, base & headrest. Note - Not suitable for 2004 onwards facelift models.				
Freelander 1 - 5 Door - Front	DA2811BLACK		DA2811GREY	
Covers in kit - 2 x back, base & headrest. Note - Not suitable for 2004 onwards facelift models.				
Freelander 1 - 3 & 5 Door - Rear 60/40 split without armrest	DA2813BLACK	DA2813GREEN	DA2813GREY	
Covers in kit - 1 x two-seat back & base; 1 x one-seat back & base; 3 x headrest. Note - Not suitable for 2004 onwards facelift models.				
Freelander 1 - 3 & 5 Door - Rear 60/40 split with armrest			DA2814GREY	
Covers in kit - 1 x two-seat back & base; 1 x one-seat back & base; 3 x headrest. Note - Not suitable for 2004 onwards facelift models.				
Freelander 1 - 3 Door Sport - 2 Rear Seats		DA2812BLUE	DA2812GREEN	DA2812GREY
Covers in kit - 2 x back, base & headrest. Note - Not suitable for 2004 onwards facelift models.				
Freelander 2 - Front	DA2821BLACK			
Covers in kit - 2 x full seat; 2 x headrest; 2 x armrest. Note - Suitable for use with airbags but not vehicles without armrests.				
Freelander 2 - Rear	DA2831BLACK			
Covers in kit - 1 x two-seat back & base; 1 x one-seat back & base; 3 x headrest & 1 x armrest. Note - Not suitable for vehicles with leather seats.				
Range Rover				
Range Rover Classic - 4 Door - Front	DA2803BLACK	DA2803BLUE	DA2803GREY	DA2803SAND
Covers in kit - 2 x back, base, armrest & headrest.				
Range Rover Classic - 4 Door - Rear		DA2804BLUE	DA2804GREEN	DA2804GREY
Covers in kit - 1 x two-seat back & base; 1 x one-seat back & base; 3 x armrest.				DA2804SAND
Range Rover P38 - Front			DA2805GREEN	DA2805GREY
Covers in kit - 2 x full seat, headrest & armrest. Note - Not suitable for vehicles with rear air bags mounted in the front seats or seats with electric headrests.				
Range Rover Sport - 2005 - 2009 - Front	DA2819BLACK			DA2819SAND
Covers in kit - 2 x full seat; 2 x headrest; 2 x armrest.				
Range Rover Sport - 2005 - 2009 - Front - vehicles with electric headrests				DA2825SAND
Covers in kit - 2 x full seat; 2 x headrest; 2 x armrest.				
Range Rover Sport - 2005 - 2009 - Rear	DA2829BLACK			
Covers in kit - 1 x two-seat back & base; 1 x one-seat back & base; 3 x headrest & 3 x armrest				
Range Rover Sport - 2010 - 2013 - Front	DA2839BLACK			DA2839SAND
Covers in kit - 2 x full seat, headrest & armrest				
Range Rover L322 - 2007 - 2009 - Front	DA2820BLACK			
Covers in kit - 2 x full seat; 2 x headrest; 2 x armrest. Note - Non-power assisted headrests only.				
Range Rover L322 - Rear	DA2830BLACK			
Covers in kit - 1 x one-seat base; 1 x two-seat base; 2 x back; 1 x middle back; 2 x headrest				

Plenty more images available to view at www.britpart.com/seatcovers



Waterproof Seat Covers - Other

Inka Seat Covers

These stylish seat cover kits also include headrest and armrest covers (where applicable) with a fitting guide. The kits are waterproof, fire retardant and washable.

VPLDS0011	Defender - 2007 onwards	Front	Black
VPLAS0130PVJ	Discovery 4	Front	Black
VPLCS0291PVJ	Discovery Sport	Front	Black
VPLFS0107PVJ	Freelander 2	Front	Black
LR005059	Freelander 2	Front	Sand
LR005058	Freelander 2	Front	Aspen
VPLSS0026PVJ	Range Rover Sport - Mk1	Front	Black
VPLWS0228SVA NEW	Range Rover Sport - Mk2	Front	Almond
VPLWS0230SVA NEW	Range Rover Sport - Mk2	Rear	Almond
		60/40 manual fold	
Range Rover Evoque			
VPLVS0070PVJ	3-door less rear entertainment	Front	Black
VPLVS0071PVJ	5-door less rear entertainment	Front	Black
VPLVS0072PVJ	2 individual 2nd row seat	Rear	Black
VPLVS0073PVJ	2nd row 60/40 folding with armrests	Rear	Black
VPLVS0077PVJ	2nd row 60/40 folding	Rear	Black
Range Rover L405			
VPLGS0154SVA		Front	Almond
VPLGS0154PVJ		Front	Black
VPLGS0155SVA	60/40 power fold	Rear	Almond
VPLGS0155PVJ	60/40 power fold	Rear	Black
Range Rover L322 - 2010 - 2012			
VPLMS0085SVA		Front	Sand
VPLMS0085PVJ		Front	Black
VPLMS0087SVA		Rear	Sand
VPLMS0087PVJ		Rear	Black

Land Rover Seat Covers

All-New Discovery (5)			
VPLRS0335PVJLR NEW	Front	Black	
VPLRS0337LKPLR NEW	Front	Nimbus	
Discovery Sport			
VPLCS0291PVJLR	Front	Black	
VPLCS0292PVJLR	2nd row	Black	
VPLCS0293PVJLR	3rd row	Black	
VPLCS0291SVALR	Front	Almond	
VPLCS0292SVALR	2nd row	Almond	
VPLCS0293SVALR	3rd row	Almond	
Range Rover L322 - 2002 - 2006			
HBD000320JMN	Front	Navy	
HBD000320LUP	Front	Aspen	
HBD000320LYR	Front	Charcoal	
HBD000320SUN	Front	Sand	
Range Rover Sport - 2014 onwards			
VPLWS0228PVJ	Front	Black	
VPLWS0229PVJ	Rear - 60/40 split	Black	
VPLWS0230PVJ	Rear - 60/40 manual fold	Black	
VPLWS0229SVA	Rear - 60/40 split	Almond	





Photo courtesy of James Rob

Seats & Trim

Are your Land Rovers seats looking old and saggy?

Our extensive range of seats and re-trim kits will smarten up your vehicle. Fitting a Britpart cubby box in your Land Rover will help keep your vehicle clutter free!

Bulkhead Bars	77
Cubby Boxes & Armrests	
Defender & Series	76
Discovery Sport.....	77
Freelander	76
Range Rover Evoque.....	77
Door Stays	84
Extended Slide Seat Rails	77
Gear Box Gaiters	78
Glove Boxes	77
Hoods	
Fume curtain	79
Hood stick kits.....	79
Hoods	79
Retrofit Seat Heaters	81
Seat Belts	78
Seat Belt Stress Plate	78
Seats	
Corbeau seats.....	83
Defender - front seats	80
Defender & Series - rear seats	81
Re-trim kits	82
Series - front seats.....	81
Sparco seats	83
Trade tack stab.....	82
XS style seats.....	82
Trim	
Chain cover.....	84
Dash trim kits.....	84
Door card fixing kit.....	84
Door trims.....	84
Seat handle & cover kit	82

Cubby Boxes & Armrests

Defender & Series



DA2035



DA2035LCS



DA2035RPI

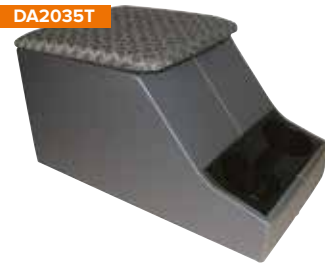

DA2035T



DA2035MESH



DA2035GREY



New black mesh trim now available

Fitting a Britpart cubby box in your Land Rover will help you keep your vehicle clutter free. With a double cup holder as standard, spilt drinks are a thing of the past. Hand-built in the UK, these quality cubby boxes are suitable for Series 3 and Defenders. Well crafted with precision tools using a hard wearing leatherette outer with locking stay brass hinges.

	Top	Body
DA2035	Black	Black
DA2035LCS	Grey	Grey
DA2035RPI	Vinyl twill	Grey
DA2035T	Techno	Grey
DA2035MESH	Black mesh	Black
XS Style		
DA2035GREY	Light grey	Dark grey

Security Cubby Box



DA2149

FWJ500020PMA

Cubby box double cup holder for both old and new model Defenders - ideal for holding a Britpart travel mug or two!!

Note - Will fit Defenders up to 2007.

To fit to existing carpet lined cubby box the lining may have to be taken out.

Excludes travel mug - DA8015.



DA2149

If security is a worry, then peace of mind can be achieved with this secure powder coated steel cubby box with padded lid. Includes a lockable slot for radios and CB units. 2 keys & 3 removable cup holders.

Freelander



DA5101



DA5103



DA5111



DA5139

Freelander 1 - 2001 - 2006

Add some support to your Freelander with one of these stylish adjustable armrests.

> Innovative design.

> Easy do-it-yourself installation.

Dimensions - 290mm long x 170mm wide x 130mm high.

DA5116	Black eco leather
DA5117	Black real leather
DA5118	Smokestone real leather



DA5116

Freelander 2 - up to 2012 - with no factory fitted armrests

Add some extra storage space in your Freelander 2 with one of these stylish cubby boxes.

> Innovative design.

> Strong ABS storage base.

> Large storage capacity.

> Easy do-it-yourself installation in only 5 minutes in the original point.

> Boxes have adjustable sliding tops.

Dimensions - 230mm long x 145mm wide x 180mm high.

DA5101	RHD	Black real leather
DA5102	RHD	Black eco leather
DA5103	RHD	Alpaca leather
DA5113	RHD	Almond leather
DA5104	LHD	Black real leather
DA5105	LHD	Black eco leather
DA5106	LHD	Alpaca leather
DA5114	LHD	Almond leather



DA5113

Freelander 2 - up to 2012 - with factory fitted armrests

Dimensions - 220mm long x 125mm wide x 160mm high.

DA5115 RHD & LHD Black real leather

DA5109 RHD & LHD Black eco leather

DA5111 RHD & LHD Alpaca leather

DA5112 RHD & LHD Almond leather



DA5115

Freelander 2 - 2013 onwards - without original armrest in the seat

> Armrest with soft pad and real stitching.

> Simple do-it-yourself fitting in only 5 minutes.

Dimensions - 280mm long x 200mm wide x 220mm high.

DA5138 RHD & LHD Black eco leather

DA5139 RHD & LHD Black automotive fabric

DA5140 RHD & LHD Black real leather

DA5141 RHD & LHD Almond real leather



DA5140

For more images - www.britpart.com/cubby

Discovery Sport



DA5142



DA5144



DA5143

Armrest with soft pad and real stitching for Discovery Sport models without one fitted originally. The armrest is made and designed using only quality materials to guarantee comfort and longevity. Handmade in Italy.

- > Innovative design.
- > Fits right and left hand drive vehicles.
- > Flips up and out of the way.
- > Soft pad.
- > Invisible fitting system - no screws or brackets in sight.
- > Do-it-yourself fitting in only 5 min.

DA5144	Black real leather
DA5142	Black eco leather
DA5143	Black automotive fabric

Range Rover Evoque



DA5122



DA5123



DA5148

Improve your driving position in a Range Rover Evoque with an additional armrest.

- > Manufactured from real leather and simple to fit.
- > The armrest can easily be moved to suit your driving position and you will still be able to access the cubby box.

Evoque with non-adjustable armrests

DA5122	Black
DA5123	Lunar
DA5124	Almond

Evoque with adjustable armrests

DA5146	Black
DA5147	Lunar
DA5148	Almond

Bulkhead Bars



DA1810



DA2351

DA1810 Defender OEM bulkhead removal bar kit

DA2351 Defender bulkhead reduction bar kit

Need more leg room and seat adjustment in your Defender?

These bulk head bars alleviate that problem without compromising strength. The bulk head bars allow for extra seat recline and travel on the seat base - giving you a more comfortable seating position and more space in the front foot wells. The bars create a rigid bracing for the front of the Defender tub as well as the added benefits of extra room in the vehicle due to the seats being more manoeuvrable, access to the rear of the Defender is now not compromised by a higher bulk head. Powder coated and supplied complete with all the necessary fixings and instructions.

Extended Seat Rails



DA2148

- > Ideal for the taller driver.
- > A more practical and comfortable driving position.

DA2148

Give your Defender (including 2007 onwards model) seats 3" of extra slide with a pair of these seat rails. Ideal for the taller driver to give a more practical and comfortable driving position. One pair of rails is suitable for one seat.



Photo courtesy of Andy Yung

Glove Boxes



DA2603



DA2603CF

Neat storage solution for the Defender - 2007 onwards model - which utilises the available dashboard space. Ideal for storing all the usual small items you carry with you. Robust construction and easy to fit with all the necessary parts supplied. Suitable for both right and left hand drive vehicles.

DA2603	Normal interior finish fascia plate
DA2603CF	Carbon fibre effect finish fascia plate

Gear Box Gaiters



DA5499

Got a Land Rover with a tatty gear box gaiter? Why not replace it with a smart new one?

DA5498	Defender	Grey
DA5499	Defender	Black
DA5497	Defender - 2007 onwards	Black
DA2466	Series	Black

Kit contents - handbrake, gearstick and 4-wheel drive selector.



DA2466

DA5498

DA5496

Discovery 1 & Discovery 2

FJL101680PMA	Gear lever	Black
FJL101710PMA	Handbrake lever	Black
FJL101530PMA	High/low lever	Black
DA5496	Re-trim kit	Black

Kit contents - gaiters for gear lever, handbrake lever & high/low lever.



DA5497



FJL101530PMA / FJL101680PMA / FJL101710PMA

Seat Belt Stress Plate



DA3502

FIA specification stress plate with 65mm square backing plate and 7/8" captive nut.



Photo courtesy of Sean Lannan

Got a great photograph of your Land Rover?

Why not enter the Britpart calendar competition for your chance to make your Landy a star. Full details can be found here - www.britpart.com/calendar



Seat Belts



DA5055

Add a splash of colour to your Defender's interior by fitting a set of these red seat belts. Type approved.

DA5055	Defender - truck cab	Equivalent to BTR6562	RHS
DA5056	Defender - truck cab	Equivalent to BTR6561	LHS
DA5057	Defender - station wagon	Equivalent to BTR6563	Front
DA5079 NEW	Defender - station wagon - Td5 onwards		RHS Front
DA5080 NEW	Defender - station wagon - Td5 onwards		LHS Front
DA5058	Defender - station wagon	Equivalent to EVL501580	Rear
NEW DA5059RH	Defender 110 - 2007 onwards	Crew cab pick up - non-hi-cap	Rear outer - right hand side
NEW DA5059LH	Defender 110 - 2007 onwards	Crew cab pick up - non-hi-cap	Rear outer - left hand side
NEW DA5060RH	Defender 110 - From YA183533 - 2007	Crew cab pick up - non-hi-cap	Rear outer - right hand side
NEW DA5060LH	Defender 110 - From YA183533 - 2007	Crew cab pick up - non-hi-cap	Rear outer - left hand side
		Equivalent to EVL000080PMAG	
		Equivalent to EVL000090PMAG	



DA5056



DA5058



Hoods

Fume Curtain



MRC3519

Defender/Series

Note - Hood stick not included - 330553

Hood Stick Kits



330999

Series 2, 2A & 3 SWB

332951

Series 2, 2A & 3 LWB



Hoods

Got a Land Rover with a hood that has seen better days?

Tears? Frayed fixings? Scratched windows?

Well give your vehicle a quick facelift with a new canvas hood from Britpart.

33110SA



33113SA



33113AG



331259SA



33110AG	Series - SWB	Full hood Khaki	Without windows
33113AG	Series - SWB	Full hood Khaki	With windows
33110SA	Series - SWB	Full hood Sand	Without windows
33113SA	Series - SWB	Full hood Sand	With windows
331371AG	Series - SWB	Three quarters hood Khaki	Without windows
331259AG	Series - LWB	Full hood Khaki	Without windows
331260AG	Series - LWB	Full hood Khaki	With windows
331259SA	Series - LWB	Full hood Sand	Without windows
331260SA	Series - LWB	Full hood Sand	With windows
MUC2437	Series - LWB - V8	High capacity pick-up ¾hood	Without windows
MUC4122ABE	Defender 90	Full hood Sand	With windows
MUC7916AG	Defender 110	¾ hood Khaki	With windows

MUC4122ABE



- > Hoods are made from the original 18oz canvas and made to OEM specifications.
- > All fittings are brass and made to OEM specifications.
- > Webbing is made the same way as the original.
- > Polypropylene rope is the same construction as the original rope.
- > Ropes are all inserted into the hood to help customers.
- > Care instruction are included.

Other hoods available on request - please ask for details.



Photo courtesy of Ryan Ramsamooj

Seats

Defender - Front Seats

Black Seats

DA4028	Seat cover	Outer base
DA4041	Seat cover	Outer back
DA4589	Seat cover	Centre base - 1990 onwards
DA4590	Seat cover	Centre back - 1990 onwards
MWC3302	Seat	Right hand back
MWC3303	Seat	Left hand back
MWC4535	Seat	Outer base
MWC1010	Headrest assembly	

Grey Seats

DA4029	Seat cover	Outer base
DA4042	Seat cover	Outer back
DA4591	Seat cover	Centre base - 1990 onwards
DA4592	Seat cover	Centre back - 1990 onwards
BTR1759LCS	Seat cover with map pocket	Outer back
MWC9844LCS	Seat	Right hand back
MWC9843LCS	Seat	Left hand back
MWC5670LCS	Seat	Outer base
MWC5628LCS	Headrest assembly	
MXC3257LCS	Left hand assembly	Less headrest

All products leaving the Trim Shop are produced to the highest standards.

Vinyl Twill Seats

AWR5701RPI	Seat cover	Outer base
AWR5702RPI	Seat cover	Outer back
DA4593	Seat cover	Centre base - 1990 onwards
DA4594	Seat cover	Centre back - 1990 onwards
AWR5698RPI	Seat	Right hand back
AWR5699RPI	Seat	Left hand back
AWR5700RPI	Seat	Outer base
AWR5708RPI	Headrest assembly	
HAD501820RPI	Right hand assembly	Less headrest
HAD501870RPI	Left hand assembly	Less headrest

Techno Style Seats

HAD501870LOY	Seat assembly with map pocket	Right hand side
HAD501850LOY	Seat assembly with map pocket	Left hand side
HAG100970LOY	Base	
HCA106010LOY	Cover base	
DA4595	Seat cover	Centre base - 1990 onwards
DA4596	Seat cover	Centre back - 1990 onwards
HAJ101400LOY	Squab assembly - no pockets	Right hand side
HAJ101410LOY	Squab assembly - no pockets	Left hand side
HBA106190LOY	Squab cover - no pocket	
HBA106180LOY	Squab cover - with pocket	
HAH103510LOY	Headrest	

Foam, Runners & Finishers

349943	Plastic corner capping for standard Defender & Series seat bases	
DA4031	Seat foam	Outer base
DA4055	Seat foam	Outer back
HGA500500	Seat foam	Back - 2007 onwards
DA4057	Seat foam	Centre base
DA4056	Seat foam	Centre back
MTC9967	Front seat edge finisher	
HHD102280	Runner & sub-frame	Right hand side
HHD102290	Runner & sub-frame	Left hand side



The highly skilled team in the Britpart Trim Shop make a wide range of seats and seat covers for Land Rover vehicles by hand. The material arrives in vast reams and has to be cut with great precision before being stitched together and then assembled into seat bases, seat backs, seat benches etc. In keeping with the Britpart philosophy, all products leaving the Trim Shop are produced to the highest standards and meet with the strictest safety regulations.

For many more pictures of our seats and trim - www.britpart.com/seats



Series - Front Seats

Black Seats

349967	Seat base	Standard outer
320699	Seat base - adjustable	Standard outer
320726	Seat base	Standard centre
320698	Seat back - bolt fitment - adjustable	Standard outer
MUC1520	Seat back - pin fitment	Standard outer
MUC1520G	Seat back - bolt fitment	Standard outer
MUC1488	Seat back	Standard centre
DA4305	Standard seat kit	

Note - Kit contains - 2 x 349967; 2 x MUC1520; 1 x 320726 & 1 x MUC1488

MRC6980	Seat base	Deluxe outer
MRC6982	Seat back	Deluxe outer
MRC6982H	Seat back with headrest	Deluxe outer
MRC6985	Seat base	Deluxe centre
MTC3181	Seat back	Deluxe centre
DA4298	Deluxe seat kit	

Note - Kit contains - 2 x MRC6982; 2 x MRC6980; 1 x MTC3181 & 1 x MRC6985

County Brown Seats

MRC6980CB	Seat base	Deluxe outer
MRC6982CB	Seat back	Deluxe outer
MRC6985CB	Seat base	Deluxe centre
MTC3181CB	Seat back	Deluxe centre

County Grey Seats

MRC6980CG	Seat base	Deluxe outer
MRC6982CG	Seat back	Deluxe outer
MRC6985CG	Seat base	Deluxe centre
MTC3181CG	Seat back	Deluxe centre



MRC6982CB



MRC6985CG

Retrofit Seat Heaters



DA5717 NEW

These retrofit seat heaters will allow you to enjoy a comfortable and warm seat in any Land Rover vehicle with a removable seat cover. These highly durable and flexible heating elements are placed between the upholstery and seat cover on the seat base and back and will not alter the shape of the seats. There are two switches provided for the driver and passenger seats which allow the heat output to be altered to the two different settings. A ready-made cable set connects the switches to the 12V on-board power supply to the heat the pads. There are integrated temperature sensors which ensure that the seat heater will not overheat.

- Operating voltage: 12 volt
- Output: Low - 44 watts / High - 90 watts
- Dimensions: Seat base - 400 x 280mm / Backrest - 300 x 280mm
- > Complete set for driver and passenger seats.
- > Two stages of heating.
- > Kit includes four heating elements and items needed for installation.
- > Pre-assembled cable set with switching relay and buttons included.
- > Temperature guard to prevent overheating.
- > Heating elements are durable and extremely flexible.
- > For use on seats which have a removable cover.
- > Includes fitting materials and instructions.
- > Test mark: e-approved to 95/54/EC (EMC guidelines for vehicles)

DA5717W

Waeco version available. www.britpart.com/DA5717W for full details

Defender & Series - Rear Seats

Black Seats

320737	Bench seat (810mm wide)	Rear assembly (inc. full fitting kit)
320647	Bench seat (810mm wide)	Rear back
396739	Bench seat (810mm wide)	Rear back - metal backed
320674	Bench seat (810mm wide)	Rear base
DA3059	Bench seat (1,200mm wide) - LWB	Rear assembly (inc. full fitting kit)
DA4067	Rear seat	Individual inward facing

County Brown Seats

320647CB	Bench seat (810mm wide)	Rear back
320674CB	Bench seat (810mm wide)	Rear base

County Grey Seats

320737CG	Bench seat (810mm wide)	Rear assembly (inc. full fitting kit)
320647CG	Bench seat (810mm wide)	Rear back
320674CG	Bench seat (810mm wide)	Rear base

Grey Seats

320737LCS	Bench seat (810mm wide)	Rear assembly (inc. full fitting kit)
320647LCS	Bench seat (810mm wide)	Rear back
320674LCS	Bench seat (810mm wide)	Rear base
DA3059LCS	Bench seat (1,200mm wide) - LWB	Rear assembly (inc. full fitting kit)
DA4075	Rear seat	Individual inward facing

Techno Style Seats

320737T	Bench seat (810mm wide)	Rear assembly (inc. full fitting kit)
320647T	Bench seat (810mm wide)	Rear back
320674T	Bench seat (810mm wide)	Rear base
DA3059T	Bench seat (1,200mm wide) - LWB	Rear assembly (inc. full fitting kit)
DA4075T	Rear seat	Individual inward facing

Vinyl Twill Seats

320737RPI	Bench seat (810mm wide)	Rear assembly (inc. full fitting kit)
320647RPI	Bench seat (810mm wide)	Rear back
320674RPI	Bench seat (810mm wide)	Rear base
DA3059RPI	Bench seat (1,200mm wide) - LWB	Rear assembly (inc. full fitting kit)
DA4075RPI	Rear seat	Individual inward facing



DA4067

DA4075T

All products leaving the Trim Shop are manufactured to the highest standard.



320737



Re-trim Kits

DA5628



Outer Seats

Defender - from VIN AA677964 to 2007 (non-plastic backed front squab)

An outer Britpart re-trim kit includes:

- 1 x Can of contact adhesive spray
- 1 x Squab foam
- 1 x Squab cover
- 6 x Plastic nails
- 3 x Cable ties
- 1 x Cushion foam
- 1 x Cushion cover
- 1 x Headrest cover
- 2 x Metal rods
- 1 x Rubber retainer

Kit excluding adhesive spray

DA5627	DA5627E	Vinyl twill
DA5628	DA5628E	Techno
DA5629	DA5629E	Black
DA5630	DA5630E	Grey
DA5603	DA5603E	Black Mesh

DA5675



Outer Seats

Defender - 2007 onwards

An outer Britpart re-trim kit includes:

- 1 x Can of contact adhesive spray
- 1 x Squab foam
- 1 x Squab cover
- 2 x Metal rods
- 1 x Rubber retainer
- 1 x Cushion foam
- 1 x Cushion cover
- 6 x Plastic nails
- 3 x Cable ties

Kit excluding adhesive spray

DA5675	DA5675E	Vinyl twill
DA5676	DA5676E	Techno
DA5673	DA5673E	Black
DA5674	DA5674E	Grey
DA5677	DA5677E	Black Mesh

DA5634



Centre Seats

Defender - 1990 onwards

A centre Britpart re-trim kit includes:

- 1 x Can of contact adhesive spray
- 1 x Squab foam
- 1 x Squab cover
- 1 x Metal rods
- 1 x Cushion foam
- 1 x Cushion cover
- 6 x Plastic nails
- 1 x Rubber retainer

Kit excluding adhesive spray

DA5632	DA5632E	Vinyl twill
DA5633	DA5633E	Techno
DA5634	DA5634E	Black
DA5635	DA5635E	Grey

New style Black Mesh material re-trim kits now available. Matching cubby box also available with Black Mesh top.



Off-roading? Got a working Land Rover?

Well the chances are your seats won't be in showroom condition, luckily Britpart have the answer - a Defender re-trim kit.

Online Fitting Guide

We have compiled a 25 minute tutorial giving you detailed step-by-step on how to disassemble and assemble your Defender seat and information on the correct use of the included parts.

The video can be found at www.britpart.com/re-trim

XS Style Seats

DA5611



Hand-built in the UK, these quality XS style seats are suitable for Defenders. Well-crafted with precision tools using a hard wearing leatherette outer and velour trim inner. Comfort is ensured with injection moulded foam. Seats complete with base, back and headrest but the runners are not included.

	Outer	Inner	Side
DA5610	Dark grey	Light grey	RHS
DA5611	Dark grey	Light grey	LHS
HHD102280	Runner & sub-frame		RHS
HHD102290	Runner & sub-frame		LHS

Seat Handle & Cover Kit

DA5495



DA5495

A pair of Defender seat handles and covers



Got a great photograph of your Land Rover?

Why not enter the Britpart calendar competition for your chance to make your Landy a star. Full details can be found here - www.britpart.com/calendar



Trade Tack Stab

DA6348

Super bond spray adhesive.

- > High strength
 - > Variable spray
 - > Quick
 - > Clean
 - > High tack/long tack
 - > Very fast set
 - > 250ml aerosol
- Ideal for bonding and laminating of polyurethane foam, polystyrene foam, fibres, fabrics & felts etc to themselves.



Sparco Seats



DA7301



DA7305



DA7302



DA7303

DA7301	Black leatherette
DA7302	Black/blue
DA7303	Black/grey
DA7304	Black/black
DA7305	Black/red
DA7306	Seat runners
DA7307	Mounting kit - removable
DA7308	Mounting kit - fixed



DA7304

- > Lightweight and compact
- > High comfort
- > Tubular frame construction
- > High quality recline mechanism for smooth and easy adjustment
- > Compatible with 3 or 4 fixing point harnesses
- > Base mounted - 271 x 345mm



These Sparco seats are ideal for the Defender (excluding truck cabs*). Drawing on decades of racing history, Sparco has created a line of street car seats that offer the ultimate in comfort and performance. The ergonomic designs help cradle and protect the driver against even the most demanding lateral forces. The R100 is Sparco's latest incarnation of ground-breaking steel-model seats. It features redesigned bolsters for greater support and new padding configurations for improved comfort. It has been built with comfort and support in mind but it's lower side bolsters and slightly narrower steel frame allow it to fit into vehicles where fitting seats with larger side bolsters may be difficult. The seat features backrest harness slots so that it can be used with a race type harness or normal seatbelts. The seats can be reclined using the double adjuster lever. Made from a durable fabric, the R100 is available in single tone or duo-tone styles. Duo-tone styles feature contrasting side accenting and stitching to match any interior. The Sparco R100 range is designed to attach using Sparco vehicle specific seat mounts.

*Not suitable for vehicles with truck cabs fitted as they restrict the leg room in the vehicle.



DA7307



DA7308



DA7306

Corbeau Seats

Corbeau Sportline RRS Low Base Seats

A revised version of the RSS, the Low Base has been designed specifically for Defender owners. The RRS has up-to-the-minute styling, giving you the ultimate in comfort and safety. This steel-framed sports recliner has a high quality moulded foam cushion, with lumbar support to give maximum comfort whilst not compromising lateral support. With its ultra low side bolster this is the perfect application for any high rise vehicle. Fitted with a high quality single reclining and tilting mechanism for ease of adjustment. TÜV Approved. Sold in pairs.

Dimensions	
Base width	500mm
Length	560mm
Height	930mm
Shoulder width	540mm
Thigh width	350mm



DA7317 NEW	Leather & Alcantara	Pair
DA7311	Dakota leather	Pair
DA7310	Vinyl	Pair

Corbeau Harness Pads

Provide extra padding for all seat belt widths. The harness pads can be used for on road, off-road or competition.

- > Provides extra padding for all seat belt widths.
- > Supplied as a pair.
- > Suitable for 50mm harness straps.
- > Velcro fastening.

DA7314	Red
DA7315	Blue
DA7316	Black

Corbeau Seat Mounting Kit

DA7313	Pair
--------	------



DA7317



DA7311



DA7310

Trim

DA2098



Dash Trim Kits

Put a stop to the dreaded Discovery 1 dash peel with one of these repair kits.

Discovery 1

DA2090	Black
DA2091	Blue
DA2096	Grey
DA2098	Brown

DA2091



Door Trim

Replace the tatty old door cards in your Defender with one of these smart plastic replacements. Easy to fit, they are also easy to keep clean with a wipe clean finish.

DA2440	Defender - 1987 - 2006	Front casing	Manual window	Black	RHS
DA2441	Defender - 1987 - 2006	Front casing	Manual window	Black	LHS
DA2442	Defender - 1987 - 2006	Front casing	Manual window	Grey	RHS
DA2443	Defender - 1987 - 2006	Front casing	Manual window	Grey	LHS
DA2490	Defender - 1987 - 2006	Front casing	Manual window	Light Grey	RHS
DA2491	Defender - 1987 - 2006	Front casing	Manual window	Light Grey	LHS
DA2444	Defender - 1987 - 2006	Front casing	Electric window	Black	RHS
DA2445	Defender - 1987 - 2006	Front casing	Electric window	Black	LHS
DA2446	Defender - 1987 - 2006	Front casing	Electric window	Grey	RHS
DA2447	Defender - 1987 - 2006	Front casing	Electric window	Grey	LHS
DA2494	Defender - 1987 - 2006	Front casing	Electric window	Light Grey	RHS
DA2495	Defender - 1987 - 2006	Front casing	Electric window	Light Grey	LHS
DA2480	Defender	Rear casing	Manual window	Black	RHS
DA2481	Defender	Rear casing	Manual window	Black	LHS
DA2482	Defender	Rear casing	Manual window	Grey	RHS
DA2483	Defender	Rear casing	Manual window	Grey	LHS
DA2492	Defender	Rear casing	Manual window	Light Grey	RHS
DA2493	Defender	Rear casing	Manual window	Light Grey	LHS
DA2484	Defender	Rear casing	Electric window	Black	RHS
DA2485	Defender	Rear casing	Electric window	Black	LHS
DA2486	Defender	Rear casing	Electric window	Grey	RHS
DA2487	Defender	Rear casing	Electric window	Grey	LHS
DA2496	Defender	Rear casing	Electric window	Light Grey	RHS
DA2497	Defender	Rear casing	Electric window	Light Grey	LHS

DA2441



DA2494



DA2492



DA2499

Defender
3 piece door lock
button kit - black



Rear door cards

Defender 1987 - 2006 with wash wipe doors.

Fixings not included

MXC1992LCS	Defender - FA358393 up to JA910753	Slate Grey
BTR3793LCS	Defender - JA910754 up to KA929577	Slate Grey
BTR7959LCS	Defender - KA929578 up to MA965105	Slate Grey
BTR9712LCS	Defender - MA965106 up to TA99921	Slate Grey
BTR9712LOY	Defender - MA965106 up to TA99921	Dark Granite
BTR9712PMA	Defender - MA965106 up to TA99921	Black

Rear door casings for Defender - up to 2002 with rear wiper motor cover.

Includes fixings.

DA2515	Defender - up to 2002	Black
DA2516	Defender - up to 2002	Dark Grey
DA2517	Defender - up to 2002	Light Grey

For more images visit www.britpart.com/door-trim

DA2124

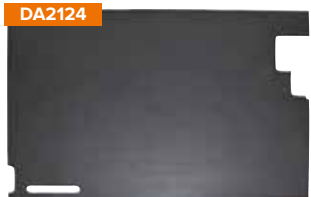

MWC1743



DA2030

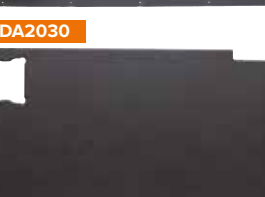

DA2124	Defender/Series	Door trim safari - 2 hinges	Black	Rear
MWC1743	Defender	Door trim safari - 3 hinges	Black	Rear
DA2029	Series	Door trim lower	Black	RHS
DA2030	Series	Door trim lower	Black	LHS

Note - Fixings not included.

Chain Cover

330422



330422

Defender - 1987 - 2006/Series

Stop your tailgate chain rattling away with this easy to fit chain cover. Single. Requires 2 per side.

Door Card Fixing Kit



DA4649 NEW

Defender door card fixing kit
Suitable for one door.

Black

Door Stays

DA1203



Does your Defender's rear door sometimes close on you unexpectedly?

This neat and easily installed gas strut kit will solve that problem and replaces the original door stopper. The gas strut will hold the door in place when open - even with a spare wheel in place - and will assist in the opening of the rear door too with a smoother and more controlled movement. Complete with fittings and instructions.

DA1204 Defender - up to 2002

DA1203 Defender - 2002 onwards

DA1204



Off-Road

Off-roading can present many unexpected challenges. Make sure that your Land Rover is prepared with our range of off-road equipment. From recovery kits to long range fuel tanks, there is a wide selection of essentials for your off-road adventures.

Air Compressors	86
Diff Lockers	
ARB.....	86 - 88
Ashcroft Transmission.....	89
Detroit.....	90
Diff lock lever kit.....	90
Emergency Equipment	
Emergency hammer.....	91
Fire extinguishers.....	91
First aid & travel kits.....	90
Recovery kits.....	91
Fuel Storage	
Jerry cans.....	91
Long range fuel tanks.....	91
Ground Anchor	93
Jacks	
Anti-rattle jack clamps.....	93
Bottle jack.....	93
Hi-Lift.....	92
Jack base.....	93
Jackall.....	92
Sand Ladder & Waffle Boards	93
Land Meters	93
Lift Rod Kit	93
PowerPacks	94
Raised Air Intakes	
Other.....	94
Safari.....	95
Tyre Repair Kit	86



Air Compressors

Double Pump

DA2392



DA2354

Single Pump



24 Months Guarantee BRITPART



Ideal for 4x4 use!

Features for both air compressors

- > Max. pressure - 150psi.
- > 10 metre air hose with heavy-duty gauge and brass fittings.
- > Integrated sand tray.
- > Blow moulded carrying case.
- > Also great for camping and outdoor use.

DA2392

Double-pump air compressor

- > Air flow - 150ltr/min
- > 12 volt / 50 amp

DA2354

Single-pump air compressor

- > Air flow - 72ltr/min
- > 12 volt / 30 amp

DA2394

Replacement cap and filter for DA2392 & DA2354

DA2354FUSE40A

Replacement fuse for DA2354

DA2392FUSE50A

Replacement fuse for DA2392

Heavy-duty gauge



3 nozzles



In-line fuse



Screw in air filter - DA2394



Built-in sand tray



Anti-vibration rubber feet



10m coiled hose



Heavy-duty battery clips



Blow moulded case



Tyre Repair Kit

Don't get caught out with a flat tyre or two!

Pack and leave an easy to use Britpart tyre repair kit in your vehicle.*

DA2390

Tyre repair kit in travel case. See the wheels section for more details on the tyre repair kit from Britpart.

* Recommended for off-road use only.



DA5078 NEW

Rapid Digital Tyre Inflator

- > Powerful inflation from a 12V socket - 4x4 tyre inflates in 5 minutes.
- > Easy and accurate set up - rotating dial to pre-set the pressure. Automatically stops once pressure reached. Screen on top of the device to read easily while using.
- > LED light built in for safer use at night.
- > Back lit digital display is easy to read.
- > Long cables to reach tyres all around the vehicle.
- > Comes with three piece adaptor kit for small inflatables & bikes.

Diff Lockers & Associated Equipment

ARB

DA419024V



DA4190 12 volt
DA419024V 24 volt

ARB High flow on-board compressor assembly

- > Airflow - 87.2lpm
- > Designed for Air Locker use.
- > Sealed for moisture and dust resistance.
- > Hard anodised cylinder bore and Teflon impregnated carbon fibre piston seal for reduced friction and maximum trouble free life.
- > Heavy-duty maxi-fuse equipped for professional in-line circuit protection.
- > Quality components for quiet operation and extra long life.
- > Anodised mounting brackets dissipates motor heat and allows compressor to be repositioned by 180°.
- > Constructed entirely of lightweight, high strength engineering grade materials.
- > Over-pressure safety valve equipped.
- > Motor is internally thermal protected against extreme temperature damage.

DA4958

ARB Compact 12 volt on-board compressor assembly

- > Airflow - 27.7lpm
- > Designed for Air Locker use.
- > Compact, vehicle mounted design.
- > Sealed for moisture & dust resistance.
- > Quality components for quiet operation & extra long life.
- > Mounting bracket allows for versatile positioning.
- > Kit contains 12V air compressor, mounting bracket & hardware, auto on/off pressure switch, plug-in Air Locker wiring loom and installation instructions.

DA4985

ARB Twin on-board compressor kit

Designed to fill the market need for a compact sized yet high-volume compressed air source to suit the high volume airflow needs of most air powered tools, and also to suit the actuation and control needs of the ARB Air Locker, and the harsh and demanding environment of the ARB Air Locker user. Much more information available online.

DA8961



4X4 ACCESSORIES

- DA4194** Dash switch for compressor and lockers
- DA4360** Front locker dash switch cover
- DA4361** Rear locker dash switch cover
- DA4362** Compressor dash switch cover
- DA8959** Switch bracket 1 switch
- DA8960** Switch bracket 2 switches
- DA8961** Switch bracket 3 switches



Quality components for quiet operation and extra long life.

ARB products available in the UK only.

ARB - continued



DA6836
 ARB Air tank
 Ideal for use with ARB's twin motor and high output on-board compressors.

- > 4 litre aluminium air tank.
- > Rated to a maximum working pressure of 1030KPA (150PSI).
- > Delivers high volume air output suitable for rapid tyre inflation and most air powered tools.
- > Two 1/4NPT ports (input and output) with JIC-4 male fitting pre-installed.
- > Designed for use with ARB's on-board compressors.
- > 50% lighter than an equivalent steel tank.
- > Mounting hardware included.



DA8994
 ARB Air compressor pressure switch
 Threads into the ARB air compressor to regulate internal pressure in the compressor tank. Turns compressor on at 70psi and off at 100psi.



DA6837
 ARB Air locker manifold kit

- > Designed for the remote mounting of air locker solenoids.
- > Stainless steel braided PTFE hose and fittings connect to and cool the compressor outlet air.

Kit includes

- > Manifold body with mounting bracket
- > 2 x 1/8" BSPP ports for installation of up to 2 x Air Locker solenoids
- > 2 x 1/4" NPT ports, one to be used as an input and the second could be used for installation of a pump up kit
- > 1 x high temperature resistant Teflon stainless steel braided hose with heavy duty JIC4 fittings
- > 2 x JIC4 - 1/4" NPT nipples to connect the included hose to the compressor outlet and manifold kit input
- > 2 x M6 hex head bolt and nylon lock-nuts for securing the manifold kit



4X4 ACCESSORIES

ARB products available in the UK only.



DA8956
 ARB Bulkhead fitting kit
 Handy little kit to help pass an airline through any panel.



DA8987
 ARB Diff side clip (ARB - RD150602)



DA8988
 ARB Diff air feed ring & pipe (ARB - RD082002)



DA8989
 ARB O-Rings
 2 x O-Rings for 24 spline air locker



DA4392
 Replacement solenoid for the compressors to activate the ARB airlockers.

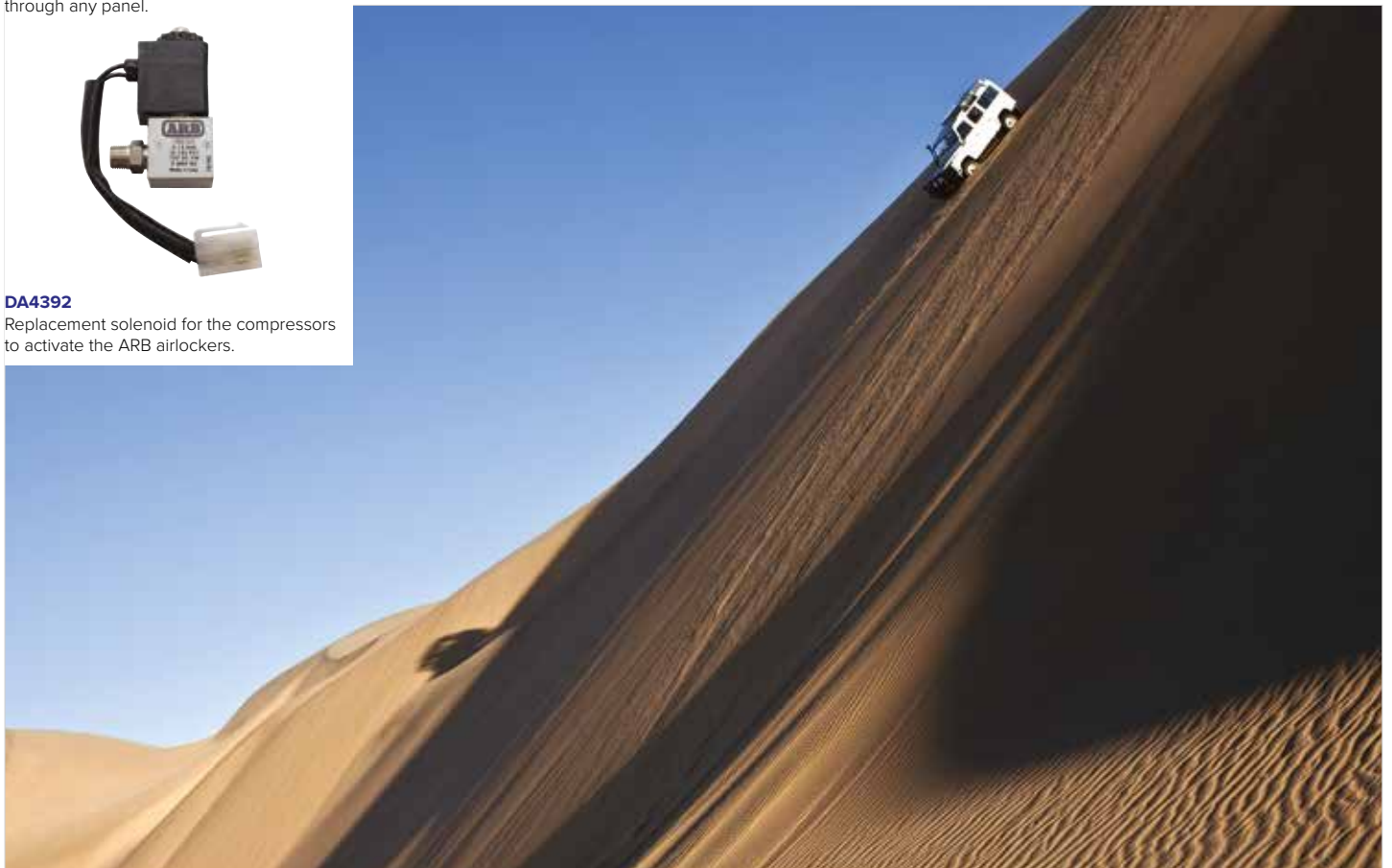

ARB - continued

ARB Diff Lockers

- > Provides 100% traction on demand without affecting on road driveability or driveline wear.
- > Vastly improved traction means less reliance on momentum, thus reducing the likelihood of vehicle damage and environmental impact.
- > Easy, convenient operation allows the driver to concentrate on the terrain without leaving the comfort and safety of their seat.
- > Ultra durable and extremely strong - only the highest quality materials used in construction.
- > Incredibly simple yet effective design that employs minimal moving parts, thereby ensuring maximum reliability.
- > Thoroughly tested and proven design - trusted and used in over 80 countries around the world.
- > Easy installation and maintenance - no special tools, skills or additives required.
- > Two year warranty guarantees the Air Locker will be free of defects in materials.

Air Locker locking differentials allow you to tackle the toughest terrain. As the world's premier traction aid, ARB Air Lockers keep you moving in all conditions. Ultra durable and extremely strong - only the highest quality materials used in construction.



Part Number	Vehicle/Model	Year	Axle Location	Shaft Description	Shaft Diameter	Spline	Ratio
Series							
DA4191 ^{2,3}	Series 1/Series 2/Series 3	1948 - 1985	Front	Rover type	28.2 (1.11")	10	4.7
DA4191 ^{2,3}	Series 1/Series 2/Series 3	1948 - 1985	Rear	Rover type	28.2 (1.11")	10	4.7
Defender							
DA4191 ¹	Defender 90	1984 - 1993	Front	Rover type	28.2 (1.11")	10	3.54
DA4193 ^{1,5}	Defender 90	1993 onwards	Front	Rover type	31.5 (1.24")	24	3.54
DA4193 ^{1,6}	Defender 90	2007 onwards	Front	Rover type	31.5 (1.24")	24	3.54
DA4191 ^{1,2}	Defender 90	1983 - 1993	Rear	Rover type, 4 cyl. petrol & diesel engines	28.2 (1.11")	10	3.54
DA4193 ^{1,6}	Defender 90	1993 onwards	Rear	Rover type	31.5 (1.24")	24	3.54
DA4344 ⁶	Defender 90	2002 onwards	Rear	Rover type, P38A	31.5 (1.24")	24	3.54
DA4193 ^{1,6}	Defender 90 with 2 pin rear diff	2007 onwards	Rear	Rover type	31.5 (1.24")	24	3.54
DA4344 ⁶	Defender 90 with 4 pin rear diff	2007 onwards	Rear	Rover type, P38A	31.5 (1.24")	24	3.54
DA4191 ¹	Defender 110/130	1983 - 1993	Front	Rover type	28.2 (1.11")	10	3.54
DA4193 ^{1,5}	Defender 110/130	1993 onwards	Front	Rover type	31.5 (1.24")	24	3.54
DA4193 ^{1,6}	Defender 110/130	2007 onwards	Front	Rover type	31.5 (1.24")	24	3.54
DA4192	Defender 110/130	1983 - 2002	Rear	Salisbury type	31.5 (1.24")	24	3.54
DA4193 ⁶	Defender 110/130	2002 onwards	Rear	Rover type	31.5 (1.24")	24	3.54
DA4344 ⁶	Defender 110/130	2002 onwards	Rear	Rover type, P38A	31.5 (1.24")	24	3.54
DA4344 ⁶	Defender 110/130	2007 onwards	Rear	Rover type, P38A	31.5 (1.24")	24	3.54
Discovery							
DA4191 ¹	Discovery 1	Up to 1993	Front	Rover type	28.2 (1.11")	10	3.54
DA4193 ^{1,5}	Discovery 1	1993 - 1998	Front	Rover type	31.5 (1.24")	24	3.54
DA4191 ¹	Discovery 1	Up to 1993	Rear	Rover type	28.2 (1.11")	10	3.54
DA4193 ^{1,5}	Discovery 1	1993 - 1998	Rear	Rover type	31.5 (1.24")	24	3.54
DA4193 ^{1,5}	Discovery 2	All	Front	Rover type	31.5 (1.24")	24	3.54
DA4193 ⁶	Discovery 2	All	Rear	Rover type	31.5 (1.24")	24	3.54
DA4344 ⁶	Discovery 2	2002 onwards	Rear	Rover type, P38A	31.5 (1.24")	24	3.54
DA6254	Discovery 3	All	Front	IRS, Clamshell type	31.5 (1.24")	29	All
Note - Check diff ratio before ordering this part.							
DA6252	Discovery 3	All	Rear	IRS, Clamshell type	33.6 (1.32")	31	All
DA6254	Discovery 4	All	Front	IRS, Clamshell type	31.5 (1.24")	29	All
Range Rover							
DA4191 ^{1,4}	Range Rover Classic	Up to 1992	Front	Rover type	28.2 (1.11")	10	3.54
DA4193 ^{1,5}	Range Rover Classic	1993 - 1996	Front	Rover type	31.5 (1.24")	24	3.54
DA4191 ^{1,4}	Range Rover Classic	Up to 1992	Rear	Rover type	28.2 (1.11")	10	3.54
DA4193 ^{1,5}	Range Rover Classic	1993 - 1996	Rear	Rover type	31.5 (1.24")	24	3.54
DA4344 ⁵	Range Rover P38	1996 - 2002	Front	Rover type, P38A	31.5 (1.24")	24	3.54
DA4344 ⁵	Range Rover P38	1996 - 2002	Rear	Rover type, P38A	31.5 (1.24")	24	3.54
DA6254	Range Rover Sport	2005 - 2013	Front	IRS, Clamshell type	31.5 (1.24")	29	All

Notes - **1.** If vehicle was manufactured during 1993, check spline count. **2.** Air Locker not available for vehicles equipped with high load option. **3.** Ring gear spacer required. Longer ring gear bolts (not supplied) are also necessary - (Land Rover part no. 576521). **4.** When an DA4191 Air Locker is to be installed in Range Rovers manufactured prior to 1980 (approx.), special carrier bearings (No. K11300/K11162) may also be necessary - Land Rover part no. RTC3426. **5.** Some vehicles have crown wheel bolts which cannot be reused and must be replaced. Consult service manual. **6.** P38A is most commonly found in traction control equipped vehicles. Identify P38A type diff by large 205mm [8.07"] flange diameter. P38A was not used on North American delivered Discoverys - use DA4193.



ARB diff cover
Defender - front and rear Salisbury axles.
High tensile solid nodular iron structure (tougher and harder than solid carbon steel) protects the differential and ring & pinion set from the obstacle impact hazards of competition rock crawling, or extreme off road trails.
More information available online.

- DA8926 Red
- DA8934 Black



Photo courtesy of Henry Bentall



4X4 ACCESSORIES

ARB products available in the UK only.

Ashcroft Transmissions

DA1224



Diff Locker

- > A unique non-rotating annular piston locking actuator is designed to eliminate air leaks sometimes found with rotating seals.
- > The annular piston is also designed to eliminate the oil blow back in the air exhaust line.
- > The large piston area gives maximum hold-in force to reduce the possibility of jumping out of lock.
- > Locking ring gives full 6mm positive engagement with side gear, again reducing the possibility of jumping out of lock.
- > Gears have been redesigned for maximum strength and durability.
- > The lock ring is made from high spec 300m steel to provide ultimate strength and ability to withstand shock loads.
- > Locking actuator cage made from steel to withstand shock loading caused by power locking.
- > Locker body turned from billet 817M40T (EN24T) to give optimum strength.
- > Only change necessary to fit the locker is drill and tap the diff housing 1/4" bsp for the air feed fitting.
- > No changes to the axle case.
- > Requires on board air supply - not supplied.

DA1224

Defender - 1993 onwards	Front & Rear
Discovery 1 - 1993 - 1998	Front & Rear
Discovery 2	Front & Rear
Range Rover Classic - 1993 - 1996	Front & Rear



Automatic Torque Biasing (ATB) Centre Differential for the LT230

DA9009

Range Rover Classic
Discovery 1
All Defenders pre-Td5 - serial numbers starting 20D, 22D, 25D, 26D, 28D, 29D, 36D

DA9009B

Discovery 2
Defender - Td5 and Tdci - serial numbers starting 41D, 42D, 43D, 57D, 60D, 61D, 62D, 68D, 69D, 70D

DA9001



Heavy-duty CV Joints

DA9001

Defender - 90/110 - non-ABS from LA930456
Discovery 1 - non-ABS - from JA032851
Range Rover Classic - non-ABS - from KA624756

DA9002

Defender - 90/110 - ABS
Discovery 1 - ABS
Range Rover Classic - ABS

DA9003

Half-Shafts

DA9003

Heavy-duty front
Defender - 90/110/Discovery 1
Range Rover Classic

DA9004

Heavy-duty rear
Defender - up to and including 200Tdi

DA9006

Heavy-duty Salisbury rear - early
Defender - up to and including 200Tdi



DA1225

Ashcroft Transmissions Cross Pin

The standard LT230 transfer boxes have a two piece cross pin in the centre diff, this is two shafts with a cut out in the centre so they can overlap. This one piece heavy-duty cross pin is much stronger.



DA9011

Automatic Torque Biasing Limited Slip Differential

Defender - 1993 onwards	Front & Rear
Discovery 1 - 1993 - 1998	Front & Rear
Discovery 2	Front & Rear
Range Rover Classic - 1993 - 1996	Front & Rear

- > Fully automatic - needs no driver input
- > Totally transparent on road, i.e., no unwanted adverse effects
- > Only comes into play when one wheel loses traction, i.e., a difference in wheel speed
- > Enhances the traction control as it multiplies the bias load created by the braking effect of the traction control
- > Needs no special oils
- > Needs no adjustment as the gears compensate for any wear that takes place
- > Only with 24 spline side gears

Heavy-duty Crown Wheel & Pinions

With the standard diff design, under extreme conditions, the front diff tries to climb out of full engagement under full power and then easily strips the teeth. Ashcroft has cut the gears in reverse for the front so they try to push together in mesh rather than push out so much stronger than the original design. Ashcroft looked at the materials used and compared these to the genuine materials used by Land Rover. The new range are now made from improved materials which is an improvement over the genuine specification. All pinions accept the later 24 spline drive flanges and have the female thread to accept the later type bolt (FS112301P) and washer (FTC5413), all ring gear threads are the stock 3/8 UNF, we stock the later flanges head high tensile bolts for these also FTC5150, see related parts. Ashcroft have chosen to coat the crown wheel and pinions in chemical black to aid corrosion resistance and offer a unique appearance.

DA1207

Front with reverse cut

Heavy-duty 4.12 ratio using a tooth count of 33 on the crown wheel and 8 teeth on the pinion.
Defender/Discovery 1/Range Rover Classic

DA1508

Rear long pinion

Heavy-duty 4.12 ratio using a tooth count of 33 on the crown wheel and 8 teeth on the pinion.
Defender - up to 7A/Discovery 1/Range Rover Classic

DA1208

Rear short pinion

Heavy-duty 4.10 ratio using a tooth count of 41 on the crown wheel and 10 teeth on the pinion.
Defender - 7A onwards/Range Rover P38

DA1207



Photo courtesy of Henry van Vliet

Diff Lock Lever Kit

DA1178

Discovery 2

Early Discovery 2's were not supplied with a centre diff lock function for the LT230 transfer case although the vehicles still have the centre diff lock installed in the transfer case. To get the diff lock function to work it just needs connecting. The linkage is easy to fit, cable operated and very neat.

You attach the existing high/low stud to this new lever assembly. This kit will only work on transfer cases with serial numbers starting with either 41D or 42D.

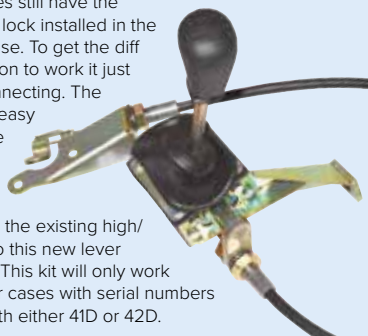

Photo courtesy of Carla Taylor

Detroit

Detroit Locker

- > 100% locking differential
- > Legendary traction
- > Ultimate performance

The legendary Detroit Locker began the revolution in performance differentials and still leads the industry today as an Eaton brand. The Detroit Locker is the most durable and dependable locking differential available.

The Detroit Locker maximises traction by delivering 100% of the torque to both drive wheels. It is engineered to keep both wheels in a constant drive mode, and has the ability to automatically allow wheel speed differentiation when required.

No other performance differential has the reputation for delivering traction in mud, snow, rocks and on the track. The choice of professional racers and off-road enthusiasts around the world! The durability of the Detroit Locker is unmatched!

DA5700 Series 3/Defender/Discovery 1/Range Rover Classic	24 spline	Rear
DA5701 Series 3/Defender/Discovery 1/Range Rover Classic	10 spline	Rear
DA5704 Defender - Salisbury axle Detroit Locker	24 spline	Rear

Detroit Truetrac

- > Smooth operation
- > Performs open until needed
- > Fully automatic limited slip

The Detroit Truetrac was the first helical gear differential ever introduced into the automotive aftermarket as an Eaton brand. It remains the leading helical gear-type limited slip differential in the industry. Detroit Truetrac's proven helical gear design eliminates the need for wearable parts, resulting in maintenance free traction.

Recognised not only for its toughness but also it's smooth and quiet operation. Engineered to work efficiently in front and rear axles, semi-floating (C-clip axles) and transfer cases. Power transfer is so smooth, it literally goes unnoticed by the driver - even in front wheel drive axles.

Proven design, low cost and effective performance, all make the Detroit Truetrac limited slip differential the ideal choice for a wide variety of vehicle applications.

No maintenance - just traction!

DA5705 Series 3/Defender/Discovery 1/Range Rover Classic	10 spline	Rear
DA5706 Series 3/Defender/Discovery 1/Discovery 2/Range Rover Classic	10 spline	Front
DA5709 Series 3/Defender/Discovery 1/Discovery 2/Range Rover Classic	24 spline	Rear
DA5710 Series 3/Defender/Discovery 1/Discovery 2/Range Rover Classic	24 spline	Front
DA5711 Defender - Salisbury axle	24 spline	Rear



"The choice of professional racers & off-road enthusiasts around the world."



IMPORTANT

When fitting a metric diff centre with metric bearings into an imperial casing you will require the additional following parts. Diffs went from imperial to metric in approximately 1983, take a look at one of the heads of the four large journal end cap bolts, if '8.8' is on the head it is metric, if not then it is imperial. Parts are required for fitting to both Truetrac or Detroit lockers.

DA5712	Spacer ring
DA5713	Imperial bearing sleeves
RTC3095	Bearings. 2 x bearings are required
576521	Longer bolts x 10

Fitting a Detroit Truetrac to the rear of a late Defender 110 will require the spacer ring DA5712. Ten longer bolts are needed too 576521 is a pack of 10.

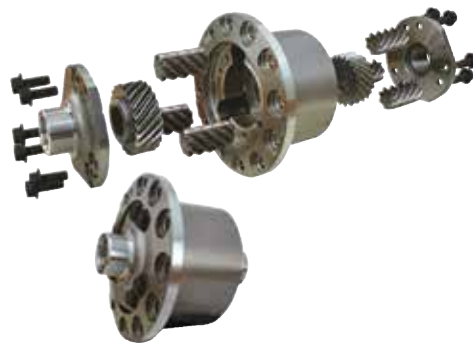

"Recognised for its toughness as well as its smooth & quiet operation."

Emergency Equipment

First Aid & Travel Kits

For first aid & travel kit contents details
www.britpart.com/safety



DA5076 NEW
Mini first aid kit
First aid kit stored in a lightweight, compact carry case. Great for people on the move and ideal for treating minor injuries. Contents are CE certified.



DA5077 NEW
Complete first aid kit
First aid kit that includes a comprehensive range of essentials items stored away in a handy case. Ideal for the car, camping, home and travel. Contents are CE certified.



DA5033
Essential emergency travel kit
Essential items for emergencies on the roadside. Compact carry case. Ideal size to store in front of the vehicle for easy access.



DA5028
European travel kit
Includes essential items when travelling to Europe. All products are manufactured to UK required standards where applicable.

Emergency Hammer

DA6500

Life Hammer - The Original

- > Double-sided steel hammer for shattering windows quickly and easily for a safe and quick exit from any vehicle.
- > Razor sharp blade cuts through seatbelts to ease escape.
- > Fluorescent button allows hammer to be located in the dark.
- > Installation mounting bracket ensures hammer is accessible when you most need it.



Fire Extinguishers

STC8138AB

STC8138AB

- > 2kg kit.
- > Long-life - 100% polyester resin coated fire extinguisher.
- > Safe handling & crash proof fastening.
- > Readiness to operate displayed by manometer.
- > Precision brass valve.



STC8529AA



STC8529AA

- > 1kg kit.
- > One-handed operation fire extinguisher.
- > High rating.
- > Checkable & re-chargeable.
- > With crash-tested bracket.
- > Attractive design.
- > Controlled discharge.

Recovery Kits

DA8932



DA8904

ARB Winch storage bag
Contains no kit

With a recovery kit you have the peace of mind carrying a purpose-built recovery bag filled with a selection of items that will come in handy the next time you get stuck.

DA8932

ARB Premium Recovery Kit

- > 8,000kg snatch strap
- > 4,500kg winch extension strap
- > 12,000kg tree trunk protector
- > 9,000kg snatch block
- > Recovery damper
- > Winch pack storage bag (available separately - DA8904)
- > Bow shackles and gloves

DA8928

ARB Essentials Recovery Kit

- > 8,000kg snatch strap
- > 12,000kg tree trunk protector
- > 9,000kg snatch block
- > Snatch pack storage bag
- > Bow shackles

DB1015

Britpart Recovery Kit

- > Wheel chocks
- > 9,000kg snatch block
- > 8,000kg tow strap
- > 8,000kg snatch tow sling
- > Bow shackles
- > Tree stop
- > Winching gloves
- > Winching blanket
- > Winch kit bag

DA8928



DB1015



Fuel Storage

Defender 90

DA4547

Defender 90 - Td5 & Tdci - up to 8A

DA4548

Defender 90 - Tdci - from 8A

- > 30 litres* plastic flow tank
- > Lightweight
- > Supplied as kit
- > Easy to install & use
- > Requires no pumps or added fillers
- > Does not interfere with storage or clearance
- > Compatible with standard Defender fuel filler cap *approximately

The best way of getting more fuel into your Defender without using valuable space or complex pumping systems!

DA4546KIT



DA4547 / DA4548

Long Range Fuel Tanks

Defender 110

DA4545

Defender 110 - up to 1999 (pre-Td5 models)

- > Rear arch metal spare fuel tank - right hand side
- > 45 litres
- > Supplied with all the necessary fittings to install and use

DA4546

Defender 110 - 1999 onwards (Td5 & Puma models)

- > Rear arch metal spare fuel tank - right hand side
- > 45 litres
- > Supplied with all the necessary fittings as well as a replacement filler neck and specifically engineered bulkhead fitting for the balance pipe, having these makes the fitting of the tank quicker and easier as well as it working better too.

Note - Both above tanks are not suitable for use in a Defender 130. Additional bracket required for 7 seater.

DA4546KIT

The long range fuel tank DA4546 will require this additional bracket when fitting to a 7-seater Defender.

DA4545



Jerry Cans



DA2170

Jerry can - 20ltr stainless steel



DA2171

Jerry can - 10ltr stainless steel



DA2167

Spout

DA2172

Stainless steel spout



DA2166

Jerry can - 20ltr



DA2182

Jerry can holder for 20ltr cans

Jacks

Hi-Lift

Rugged & Highly Versatile Jacks

The Hi-Lift jack is a rugged, highly versatile jack that puts you in command of situations requiring lifting, pushing, pulling, winching, and clamping. Although light in weight and easy to manoeuvre, the Hi-Lift jack offers a rated lifting capacity of 2½ tons (2,114kg).

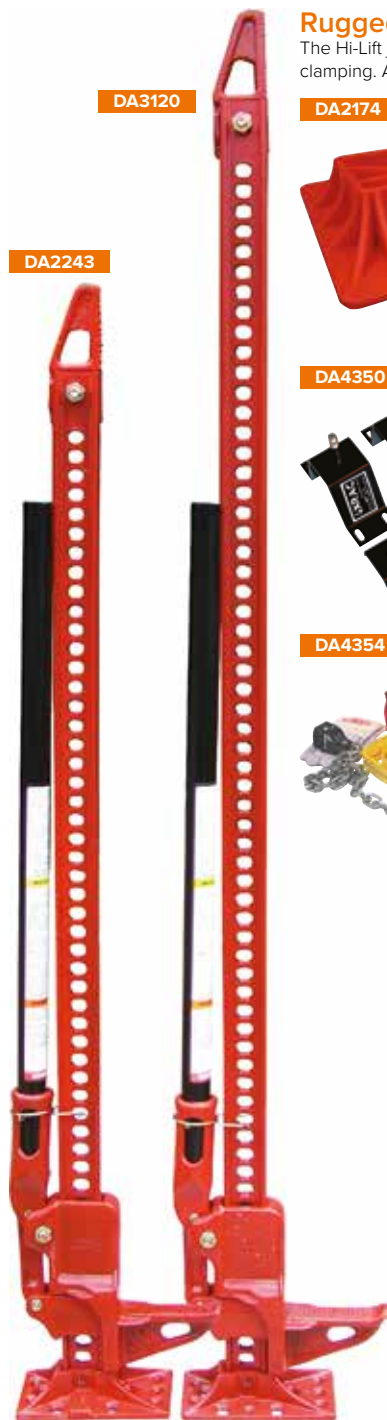

DA2243 48" Jack (4ft)
DA3120 60" Jack (5ft)

Specifications

- > Approximate weight: 30lbs (14kg).
- > 4,660lbs (2,113kg) rated capacity.
- > Climbing pins of specially processed steel with 125,000psi tensile strength and 100,000psi yield.
- > Steel bar is manufactured of specially rolled extra high carbon steel with 80,000lbs minimum tensile and carbon 0.69 to 0.82.
- > Steel handle of 14-gauge high-yield structural tubing with minimum yield of 55,000psi - 15/16" diameter x 30" long.

Features

- > Every jack comes complete with an adjustable top clam clevis for use in clamping and winching.
- > For speedy disengaging, lifting unity automatically drops away when load is removed.
- > 4½" (11cm) long lifting nose for positive contact with load.
- > Safety bolt is designed to shear at 7,000lbs (3,175 kg).
- > Steel bar can be reversed for extra long life.
- > Low pickup of 4½" (110mm).
- > 28" square base plate.



Accessories

- DA2174** Off-road base plate - Alleviates jack sinkage on soft surfaces - suits both models.
- DA2243EYE** Jacking eye - Spare jacking eye.
- DA2244** Jacking point adaptor - Allows the use of the jack with the standard jacking points on a Defender.
- DA2248** Fix-it-kit - The maintenance kit contains all the key components for servicing all Hi-Lift jacks.
- DA4350** 4XRAC - Heavy-duty mounting system for the serious off-roader.
- DA4351** Loc-Rac - Conveniently mounts and locks your Hi-Lift jack. Includes lock and suits all models.
- DA4352** Jack protector - The jack protector vinyl bag protects your jack from the elements - one size fits all.
- DA4353** Lift mate - Designed to provide a lift point from most wheels for quick and easy lifting. Lifting capacity is 5,000lbs/2,273kg.
- DA4354** Off-road kit - The Hi-Lift winching kit includes a winch attachment, winch tensioner, tree strap, d-ring shackle, Hi-Lift gloves and gear bag. Winch time is reduced significantly using the winch attachment and tensioner together.
- DA4355** Bumper lift - Designed to fit curved steel bumpers. Rugged design of the bumper lift has a lifting capacity of 3,000lbs/1,361kg.
- DA4356** Neoprene jack cover - This jack cover offers a level of mud and dirt protection for the main lifting mechanism of the jack when not in use. It zips on easily over the foot of the jack and provides a tight fit.
- DA4357** Adjustable tube jack mounts - small set - For use on tubes from 1 to 2" in diameter, which works on many roof racks. It can also be used on ATV/UTV bars, bumpers and roll cages.
- DA4358** Adjustable tube jack mounts - large set - For use on tubes from 2 to 3" in diameter that will work on most vehicle bull bars and roll cages.

Jackall

Built with a patented 'Safety Link', the Maasdam Jackall is the 'Jack with More!' Larger base for greater stability. 'Safety Link' mechanism that prevents abuse, misuse and makes operations safer. Jacks come with a lifetime warranty and are built to current ANSI/ASME specifications. When safety and dependability matter most, continue to rely on Jackall.

Features & Benefits

- > Patented 'safety link' mechanism which prevents abuse and misuse.
- > Heavy ribbed, extra large base which provides strength and greater load stability.
- > Cast components assures long life, trouble free operation.
- > Hot roll-formed, alloy steel beam which is strong and reliable.
- > Steel handle locks against beam for convenient storage.
- > Powder coated through and through which reduces scratching, greater corrosive resistance.

- DA3121** 48" Jack (4ft) - 8,000lbs capacity
- DA3122** 60" Jack (5ft) - 8,000lbs capacity
- DA3130** Top clamp
- DA4058** Maintenance kit
- DA4059** Jacking point adaptor
- DA4061** Mounting kit jack rack

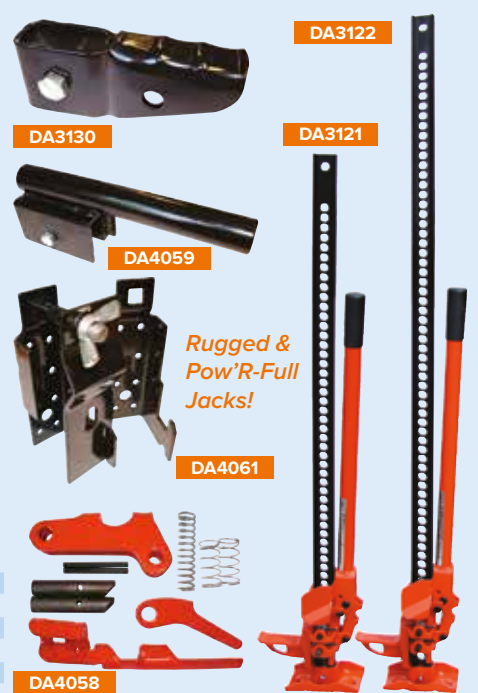

Rugged & Pow'R-Full Jacks!

Anti-rattle Jack Clamps

- DA3153 Red
- DA3154 Black
- DA3155 Yellow



Bottle Jack

- ANR4489 Bottle jack kit (LR031924 & KAH000050)
- LR031924 Bottle jack
- KAH000050 Handle for bottle jack (LR031924)
- Note - Defender only



Jack Base

- DA5607 Jack base
- 310 x 195 x 38mm
- Grey



Ground Anchors

DA6541

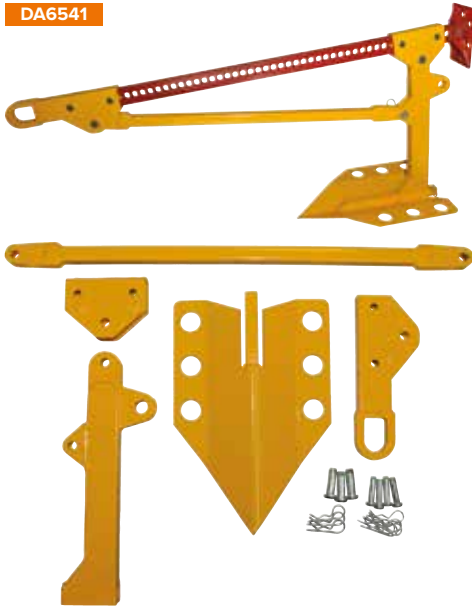

DA6541
Ground anchor
Pull yourself out of trouble with this heavy-duty ground anchor. This anchor utilises a Hi-Lift jack (not included).

DB1314



DB1318



- DB1314 Ground anchor set - 600mm pins
- Ground anchor bag set
- DB1318 2 x Pulling Power bags
- Note** - ground anchor not included (DB1314)

Sand Ladder & Waffle Boards

DA2231



DA5600



Help to get yourself out of trouble...

- DA2231 Sandtrack Aluminium Pair
1,500 long x 390 wide x 4mm thick
- DA5600 Waffle boards Fibreglass Pair
1,220 long x 260 wide x 50mm deep
Grey with gritted surface for extra traction
- DA5601 Waffle boards Fibreglass Pair
1,220 long x 270 wide x 38mm deep
Grey with gritted surface for extra traction
- DA4587 Recovery tracks Plastic Pair
1,210 long x 325 wide x 60mm deep Max load - 3.5 tons

DA4587



Land Meters

- > Independent twin meter.
- > Convenient for seeing the pitching and rolling of the vehicle body or terrain.
- > Transparent illumination for easy-to-see readings at night.

- DA1003 Double incline land meter Black
- DA1004 Double incline land meter Carbon fibre effect



Lift Rod Kit

DA7531



DA7531
Fully adjustable suspension lift rod kit
Discovery 3/Discovery 4/Range Rover Sport - 2005 - 2013
"The ease of changing the ride height is what separates these rods from others in the marketplace."

These adjustable rods replace the plastic and rubber parts Land Rover supply on the vehicle. Made from aluminium with an industrial heavy grade rubber bushing, the aluminium parts are anodised black to help with corrosion protection and blending in when in the garage for work.

The lift rods have two settings; standard and off-road. With the air suspension set to normal driving height the lengthened rods will give you standard road and off road driving heights. If you shorten the rods the standard ride height will be approx 50mm higher. If you select off-road height the vehicle will be in the 'super extended' position.

No tools are required and should take no more than 2 minutes to do all four rods.

Access to the front is over the front wheels and for the back is through the rear wishbones (blanket required!)

Note - If run for a long time in off-road position then wheels may need realigning.



Sign up to the regular Britpart newsletter to find out about all the latest product releases.

www.britpart.com/newsletter

PowerPacks

XS PowerPack
MULTI-FUNCTION JUMP STARTER



- DA1239 UK mains plug
- DA1239EU EU mains plug
- DA1256 Replacement jump leads for DA1239
- DA1255 12V cigarette lighter adaptor

Technical Specifications

Battery volume: 18,000mAh
Starting current: 300A

Size: 230 x 87 x 27mm
Weight: 615g
Output: 5V = 2A (smart phone/tablet fast charge)
12V = 10A
19V = 3.5A (laptops/notebooks)
Input: 14V = 1A
Peak current: 600A

- > Small and lightweight high capacity nano lithium polymer portable power pack with the latest battery technology.
- > Supports fast charging with low self-discharge cycle.
- > Charging cycles can reach more than 1,000 times.
- > Supports 12V jump starts as well as back up charging or many brands of mobile phones, laptops, tablets, portable refrigerators etc.
- > Supports 3 different types of charging modes.
- > Built in redundant electronic control safety protection for jump starter over-charging and over-discharging.

XD PowerPack
MULTI-FUNCTION JUMP STARTER



- DA1238 UK mains plug

Technical Specifications

Battery volume: 9,000mAh
Starting current: 200A

Size: 131 x 75 x 25mm
Weight: 300g
Output: 5V = 2A (smart phone/tablet fast charge)
Input: 14V = 1A
Peak current: 400A

- > Small and lightweight portable power pack with the latest nano lithium battery technology.
- > High capacity, high power special battery.
- > Supports fast charging with low self-discharge cycle.
- > Charging cycles can reach more than 1,000 times.
- > Supports 12V jump starts as well as back up charging for many brands of mobile phones, tablets etc.

The XS & XD PowerPacks are handy to keep with you on your travels to ensure you never run out of 'juice'!

See them both in action at www.britpart.com/powerpack



Jump Starter PowerPack



Laptops



Tablets



Jump Starter PowerPack



Tablets



Plus more...



Mobile Phones



Portable Games



Portable DVD



Music Players



Mobile Phones



Portable Games



Digital Cameras



Music Players



DA1255

DA1239 kit contents
Excludes DA1255



DA1238 kit contents



Raised Air Intakes

Other



NRC6920

This version from Britpart is a classic mushroom-top snorkel for Defender. Featuring heavy-duty metal pipe work, cyclone pre-cleaner and a durable attractive matt black finish.

- DA2225 Defender - 300Tdi/Td5
- PHD500340 Defender - 2007 onwards
- NRC6920 Raised air intake cleaner for DA2225 & LR008383 Inside diameter - 64mm

If your likely to be driving your Land Rover in circumstances which could mean wading deep water or driving in very dusty conditions then you should consider fitting a raised air intake to your vehicle.



Photo courtesy of Christie Conely

Safari

Pioneered in Australia in the early 1980's, Safari Snorkels were born out of a need to protect 4WD engines from the hazards of dust and water commonly encountered in touring and off road applications.

Safari snorkels are manufactured to the highest standards in durable, UV stable, cross linked polyethylene material, using stainless steel hardware where appropriate. Each system includes quality fixtures and fittings, which offer superior sealing, presentation and long-term durability.

In arguably the best, if not toughest environment, Safari Snorkel Systems are thoroughly researched, tested and tooled for each model of Land Rover. The Safari Snorkel delivers a continuous and cooler supply of air for maximum engine performance. It is positively sealed as well to ensure the best protection against deep water crossings and dust.



Defender

DA3024

Defender - 200Tdi - 1990 - 1994

DA3025

Defender - V8 - 1984 - 1994

DA3026

Defender - 300Tdi - 1994 - 1999

DA3069

Defender - Td5 - 1999 onwards

Defender - 2007 onwards

DA2374

Stainless steel air ram grille. Shown attached to air ram - grille only. Will not fit DA3069 snorkel.

DA3141

3" replacement air ram for DA3024

DA3142

3½" replacement air ram for DA3025, DA3026, DA3027, DA3027LH, DA3069

Note - Fitment from seated internal view - RHS - right hand side and LHS - left hand side.

Snorkel fitment side

LHS

RHS

RHS

RHS

Discovery

DA3015

Discovery 1 - 200Tdi - 1990 - 1994

DA3018

Discovery 1 - V8 - 1990 - 1994

DA3020

Discovery 1 - 300Tdi (non-EGR)

Discovery 1 - V8 - 1994 - 1999 (non-ABS)

DA3022

Discovery 1 - 300Tdi (non-EGR)

Discovery 1 - V8 - 1994 - 1999 (ABS)

DA3023

Discovery 2 - Td5

Discovery 2 - V8 - 1999 onwards

DA3021

Discovery 3 - TdV6 SE/Discovery 4 - TdV6

DA2374

Stainless steel air ram grille. Shown attached to air ram - grille only.

DA3141

3" replacement air ram for DA3015, DA3018, DA3020, DA3022, DA3023

DA3142

3½" replacement air ram for DA3021

Note - Fitment from seated internal view - RHS - right hand side and LHS - left hand side.

Snorkel fitment side

LHS

LHS

LHS

LHS

LHS

LHS

RHS



Safari snorkels are manufactured to the highest standards in durable, UV stable, cross linked polyethylene material.

For more Safari Snorkel pictures visit - www.britpart.com/safari

Watch Tim & Fuzz explore Britpart...
www.britpart.com/videos





Photo courtesy of LRO Magazine

Winching

Never get stuck again with a Britpart Pulling Power electric winch and winching accessories. We've got everything you need to make sure that you don't get caught in a sticky situation and that you can recover yourself safely!

Batteries

Alternator upgrade kit	99
Battery charger	98
Comfort connectors	98
Dual battery management system	99
Optima batteries	98
Replacement batteries	98
Split charge relay	99

Britpart Winches

Winches	100 - 103
Winch spare parts	103

Tamper Proof Nuts & Bolts.....104

Winch Bumpers

Winch bumper kits	104
Winch bumpers	105

Winching Accessories

Fairleads	106
Other essential winching accessories	108
Ropes & strops	106
Safety equipment	108
Shackles & pulleys	107
Winching accessory kits	108



Batteries

Optima Batteries



DB1021



DB1019



DB1020



DB1018



Yellow Top Batteries

Voltage - 12v
Capacity - 55Ah
Cold Cranking Amps (CCA) - 765
DB1018 Top terminals
DB1020 Top & side terminals

Red Top Batteries

Voltage - 12v
Capacity - 50Ah
Cold Cranking Amps (CCA) - 815
DB1019 Top terminals
DB1021 Top & side terminals

With its patented Spiralcell® Technology, Optima batteries offer 15 times the vibration resistance and up to twice the life of ordinary batteries. The Optima is like no other battery found in today's market. Optima's unique patented Spiralcell® design offers the best technology by providing a strong and clean power source that far surpasses any of today's traditional lead acid batteries. With Optima as your choice, you can count on a longer lasting battery.

Yellow Top

Demand more from your vehicle? Then get more from your battery. Optima Yellow Top batteries are made for the extremes. If your vehicle is designed to take the abuse of off-road driving, you need increased performance and reliability from your battery. Optima batteries combine patented Spiralcell® Technology to deliver that performance. The deep cycle characteristics of this technology coupled with its extreme resistance to vibration provides performance vehicles with the repetitive power they need, packaged in a spill-proof compact design.

If your vehicle is fitted with high drain accessories such as additional lighting, tracking devices, ICE systems, winches, hydraulics etc, then this ultimately demands more from your battery. Optima Yellow Top batteries provide the extra performance and deep cycling capability that your vehicle demands.

Red Top

Optima Red Top batteries are built to withstand the abuse 4x4's experience on and off-road. Spiralcell® Technology immobilises the internal components of the battery, enabling Optima batteries to withstand incredible amounts of vibration.

Vehicles modified for improved engine performance demand more from a battery. Optima batteries withstand the high engine bay temperatures associated with these performance vehicles. The sealed construction makes the battery spill-proof, even if you install it on its side!

This prevents external gassing and leaking which can damage engine components and reduce battery performance.

If your battery is used in applications that demand extra reliability endurance and performance, or if you just take pride in getting the best performance out of your vehicle, Optima Red Top batteries deliver the performance you demand.

Battery Charger

DA3185R

Multi-Stage Fully Automatic SmartCharger From Ring - the ultimate in battery maintenance. Diagnose, repair, recondition and charge in one automatic device. Ideal for long-term connection and winter charging. This is battery care made easy. This charger is a multi-award winning SmartCharger. It has won the Automechanika Madrid Exhibition Award for Innovation, Auto Express' Product of the Year and Land Rover Monthly's Best Buy.

- > Multi stage fully automatic SmartCharger.
- > Auto charge applies the fastest charge, based on battery size.
- > Includes settings for both standard vehicles and Start/Stop.
- > Includes battery repair tools to increase performance and battery life.
- > Charging current up to 12A.
- > Battery capacity: 25-300Ah.
- > Interactive LCD display.
- > Memory saver function allows vehicle and audio settings to be retained if the battery is removed.
- > Product dimensions - 139mm high x 197mm wide x 74mm deep
- > Weight - 1.48kg
- > Voltage - 230V AC input & 12V DC output



- > Includes the following battery and alternator analysis tools:
 - Start power test – measures voltage drop during engine start to identify potential battery issues
 - Alternator check – tests the recharging performance of the vehicles alternator
 - Battery cranking performance – measures the battery's cold cranking performance to determine engine starting ability

Keep your batteries in tip-top condition

Replacement Batteries

- > Batteries are manufactured on the same equipment as OE batteries and use the same components to give consistent quality and performance.
- > Original equipment (OE) quality standards, giving assurance that the batteries will not let the user down.
- > Batteries are recyclable, helping to protect the environment.

	Capacity	CCA*
STC4757	70Ah	500
YGD500100	70Ah	640
LR038128	80Ah	770
LR072855	95Ah	855
LR033179	95Ah	855
LR030213	95Ah	855
LR038341	95Ah	855
LR094642	95Ah	855
YGD500130	95Ah	855
YGD100860	100Ah	1000mCA
STC8587	110Ah	750
YGD000271	110Ah	920

*Cold cranking amps



Comfort Connectors



DA1409 7-pin charging adaptor

DA1410 13-pin charging adaptor

CTEK comfort connector adaptors allows a vehicle's battery to be charged through the caravan towing electric socket. The vehicle must have fully populated towing electrics for these adaptors to work. For use with CTEK Multi-XS7000 universal battery charger.



Photo courtesy of Dave Warren

Alternator Upgrade Kits

DA1195



200Tdi alternator upgrade kits.
Kits include uprated cable.
DA1195 Defender - 200Tdi
Upgrade the 45A alternator to 100A
DA1196 Discovery 1 - 200Tdi
Upgrade the alternator to 100A

DA1174

This fully automatic Microprocessor Controlled Dual Battery Management System separates the starter battery from auxiliary battery if the vehicle has stopped and links them while the car is running. All systems are equipped with a 200A power relay. For emergency situations all systems are equipped with the manual override function (link). This manual linking function (called load sharing) is very helpful for jump starting or when using high current appliances such as an electrical recovery winch, power inverter or compressor. The kit includes a 4.7m wiring loom with sealed automotive plug, battery and crimp terminals for easy installation. The battery monitor is installed in the vehicle (dash) and informs the driver about the charge level of both batteries, the charging voltage from the alternator or an additionally installed solar system and the relay link status. The system offers low battery alarm on both batteries and a link failure alarm. Includes a manual link for 30 and 120 minutes with automatic return.

Functions

Display of Battery Voltage (Energy Level)

LED indicators:

- Green: Batteries are in the safe working range
- Yellow: Check batteries
- Red: Batteries should be charged

The LED's show the energy level if all loads are switched off:
12.6V = 100% / 12.4V = 75% / 12.2V = 50% / 12.0V = 25%
11.0V = flashing and beeping indicates low battery situation
This function is called by pressing the display button for about 30 seconds.

Display of Charge Voltage while charging

LED indicators:

- Red: >14.5V: High loading of batteries, may be present at cold ambient temperature for a longer time.
- Yellow: >14.0V: Proper charge mode.
- Green: <14.0V: Save charge mode, no damage to batteries.

Bi-directional Automatic Battery link

While the engine is running the main and auxiliary batteries are linked together for parallel charging from the alternator (green LED linked is on). If the engine is stopped, the two batteries will be disconnected automatically with some delay. Appliances such as fridges, lights, compressors, inverters are now safely fed from the auxiliary battery. With the additional charge by solar equipment, battery charger or generator is sufficient for charging, the starter battery will be charged automatically with auxiliary battery together (green LED "link" lights).

Manual Battery "link"

In an emergency situation (defective or empty main battery) or in case of higher power consumption the two batteries (main & auxiliary) may be connected together by activating the link button (red LED manually linked is on). After a lapse of time of 30 minutes (or immediately after activating the auto button), the system returns to the automatic mode. When using an electric winch, the battery connection can be activated for 120 minutes by pressing the link button twice. In this mode sounds a beep every 30 seconds to remind of this status (auto return after time expired). The load sharing function with the manual battery connection reduces the load on the alternator, the wiring and the batteries in the use of the winch.

Alarm functions:

Low battery alarm

If the battery voltage of one or both of the batteries, is for a longer period below 12V, the sound low battery with "Beep" and the LED "Low Battery" of the corresponding battery (main and / or auxiliary) flashes. With the display button, the "Beep" is switched off. The blinking LED "Low Battery" is reset if the battery voltage is exceeding 12V.

Link failure alarm

The monitor monitors the charge on both batteries. When fitting a charge (from alternator, solar, charger) no charge to the other battery is detected, the link error alarm with flashing green LED "linked" and the "Beep" sounds. If this error occurs, check immediately the wiring of the power cables to (relay, battery terminals, crimp contacts, control relays). After bug fixes, alarm will automatically reset.

Deactivation of automatic and manual battery dual link function

Is there a problem with the auxiliary battery (aux) as short circuit of cells, short circuit or defective battery housing, leading to damage of the generator (alternator). In an emergency situation the battery system can be operated in the vehicle in the basic configuration (alternator, starter battery without additional charge to auxiliary battery). By pressing the link button for 6 seconds (until the sound of the beep), the link is deactivated. In this mode, no manual and automatic battery connection is possible. This feature can solve the battery problem of the auxiliary battery by pressing the auto button for 6 seconds to be reset. Now the system is working again with all the functions.

Microprocessor Controlled Dual Battery Management System



Winch application

Connect an electrical recovery winch to the main battery as shown in the wiring diagram.

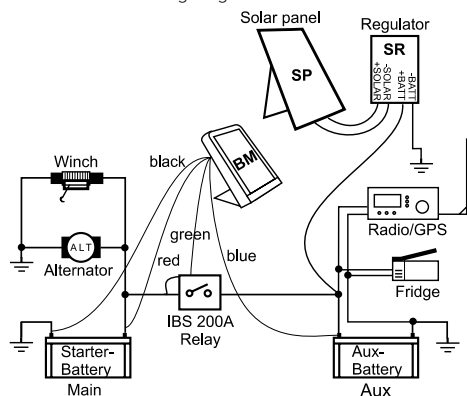

Specifications

Supply voltage	4 - 16V
System voltage	12V
Measuring range (sense wire blue)	8 - 16V
Display range (battery voltage)	11.0V - 12.8V
Alarm level main and aux	12.0V
Display range (charge)	13.0V - 14.5V
Accuracy	+/-1%
Consumption monitor	1mA
Consumption max. display active (30 sec)	20mA
Isolator link-on/off threshold	13.1V/13.0V
Consumption on-state (relay)	0.6A
Relay continuous load current	200A
Relay current inrush	500A
Relay contact material	Silver (AG SnO2)
Free combination of batteries possible?	Yes
Operating temperature	-40°C - +80°C
Housing	ABS black
Sealing level	IP40
Size, dimensions	100 x 65 x 24mm
Weight	800g
Cabling	Red - Supply/sense (main battery) Black - GND (main battery) Blue - Sense (aux battery) Green - Control relay (open collector)

Protected against

Wrong polarity & against overload of solenoid driving circuit on PC board with SMD electronically security devices, no fuses have to be replaced.

Kit contents -



Mounting Options

- DA1174GM** Mounting plate with flexible arm
- DA1174SM** Mounting plate with swivel mount
- DA1174HM** Mounting plate with swivel arm



Split Charge Relay



DB1500

Heavy-duty 200A split charger

Winches



BRITPART® PULLING POWER

If you are serious about off-roading then a winch is an essential piece of kit. They are indispensable when getting yourself and others out of tricky situations.

The Britpart Pulling Power range of powerful and reliable electric winches all feature a planetary gear system for fast line speed, free spooling, power in & power out and low electric current. Now with the larger winches you have a choice of having the traditional steel cable fitted or Dyneema rope.

A full range of winching equipment is also available from Britpart - including; safety gear, bumpers, chocks, hooks, shackles & ropes.

Together with the winches you'll be able to **'Get to where you want to go!'**

Features	OB12000i	OB9500i	OB9000C	OB6000	OB2000
Motors	3.6Kw (4.8Hp) Heavy-duty series wound DC motor	3.6Kw (4.8Hp) Heavy-duty series wound DC motor	3.3Kw (4.5Hp) Permanent magnetic DC motor	2.7Kw (3.6Hp) Permanent magnetic DC motor	1.0Kw (1.5Hp) Permanent magnetic DC motor
Models available	12 volts & 24 volts	12 volts & 24 volts	12 volts	12 volts	12 volts
Steel cable or Dyneema rope	Steel cable or Dyneema rope	Steel cable or Dyneema rope	Steel cable or Dyneema rope	Steel cable	Steel cable
Weather & dustproof contactor controls	✓	✓	✓	✓	
Planetary gear system for fast line speed	✓	✓	✓	✓	✓
Automatic load holding brake	✓	✓	✓	✓	
Free spooling	✓	✓	✓	✓	✓
Power in & power out	✓	✓	✓	✓	✓
Low electric current	✓	✓	✓	✓	✓
Hardened drum	✓	✓	✓		
Specifications					
Rated line pull - single line	5,443kgs 12,000lbs	4,309kgs 9,500lbs	4,082kgs 9,000lbs	2,722kgs 6,000lbs	907kgs 2,000lbs
Gear reduction ratio	294:1	212:1	212:1	210:1	153:1
Motor size	3.6Kw 4.8Hp	3.6Kw 4.8Hp	3.3Kw 4.5Hp	2.7Kw 3.6Hp	1.0Kw 1.5Hp
Drum size - D x L	67 x 228mm 2.64 x 9"	67 x 228mm 2.64 x 9"	63 x 228mm 2.5 x 9"	63 x 140mm 2.5 x 5.51"	32 x 71mm 1.26 x 2.8"
Steel cable - size	9.53mm x 30.5m 0.38" x 100'	9.53mm x 30.5m 0.38" x 100'	9.53mm x 30.5m 0.38" x 100'	7.94mm x 26m 0.31" x 85'	4mm x 15.2m 0.16" x 50'
Dyneema rope - size	11mm x 28m 0.43" x 91.9'	11mm x 28m 0.43" x 91.9'	11mm x 28m 0.43" x 91.9'	N/A	N/A
Overall dimensions - L x W x H	548 x 167 x 299mm 21.57 x 6.57 x 11.77"	548 x 167 x 299mm 21.57 x 6.57 x 11.77"	560 x 160 x 280mm 22.0 x 6.3 x 11.0"	438 x 158 x 185mm 17.24 x 6.22 x 7.28"	320 x 105 x 111mm 12.6 x 4.13 x 4.35"
Steel cable - net weight	43.0kgs 94.8lbs	43.0kgs 94.8lbs	38.0kgs 84.0lbs	31.8kgs 70.0lbs	6.6kgs 14.6lbs
Dyneema rope - net weight	33.0kgs 72.8lbs	33.0kgs 72.8lbs	31.0kgs 68.3lbs	N/A	N/A
Mounting bolt pattern	254 x 114.3mm 10 x 4.5"	254 x 114.3mm 10 x 4.5"	254 x 114.3mm 10 x 4.5"	166 x 114.3mm 6.54 x 4.5"	48 x 76mm 1.89 x 3.0"

Winches - continued



IMPORTANT
When fitting a winch to a Defender don't forget to order the extended winch wiring kit with cut-off switch. Part number **DB1014**



DB12000i

Performance of 1st Layer								Line Pull & Cable/Rope Capacity by Layer							
Line Pull		Line Speed				Motor Current		Rope Layer	Rated Line Pull		Rope Capacity				
		12 volt		24 volt		12 volt	24 volt				Steel Cable		Dyneema Rope		
Lbs	Kg	Fpm	Mpm	Fpm	Mpm	Amp	Amp	Lbs	Kg	Feet	Meters	Feet	Meters		
0	0	14.0	4.2	16.8	5.1	90	68	1	12,000	5,448	15.0	5.0	13.8	4.2	
4,000	1,816	9.2	2.8	11.3	3.5	190	140	2	10,200	4,631	38.0	11.5	31.2	9.5	
6,000	2,724	7.9	2.4	9.5	2.9	230	165	3	8,400	3,814	64.0	19.5	51.5	15.7	
8,000	3,632	6.9	2.1	8.4	2.5	260	190	4	7,300	3,314	95.0	29.0	76.4	23.3	
10,000	4,540	6.5	2.0	7.8	2.4	300	220	5	6,500	2,950	100.0	30.5	91.9	28.0	
12,000	5,448	5.9	1.8	7.0	2.2	330	245								

Galvanised aircraft cable with break force - 14,400lbs
DB12000i Britpart 12,000lbs winch 12 volt
DB12000i24 Britpart 12,000lbs winch 24 volt

Dyneema rope with break force - 25,800lbs
DB12000iR Britpart 12,000lbs winch 12 volt

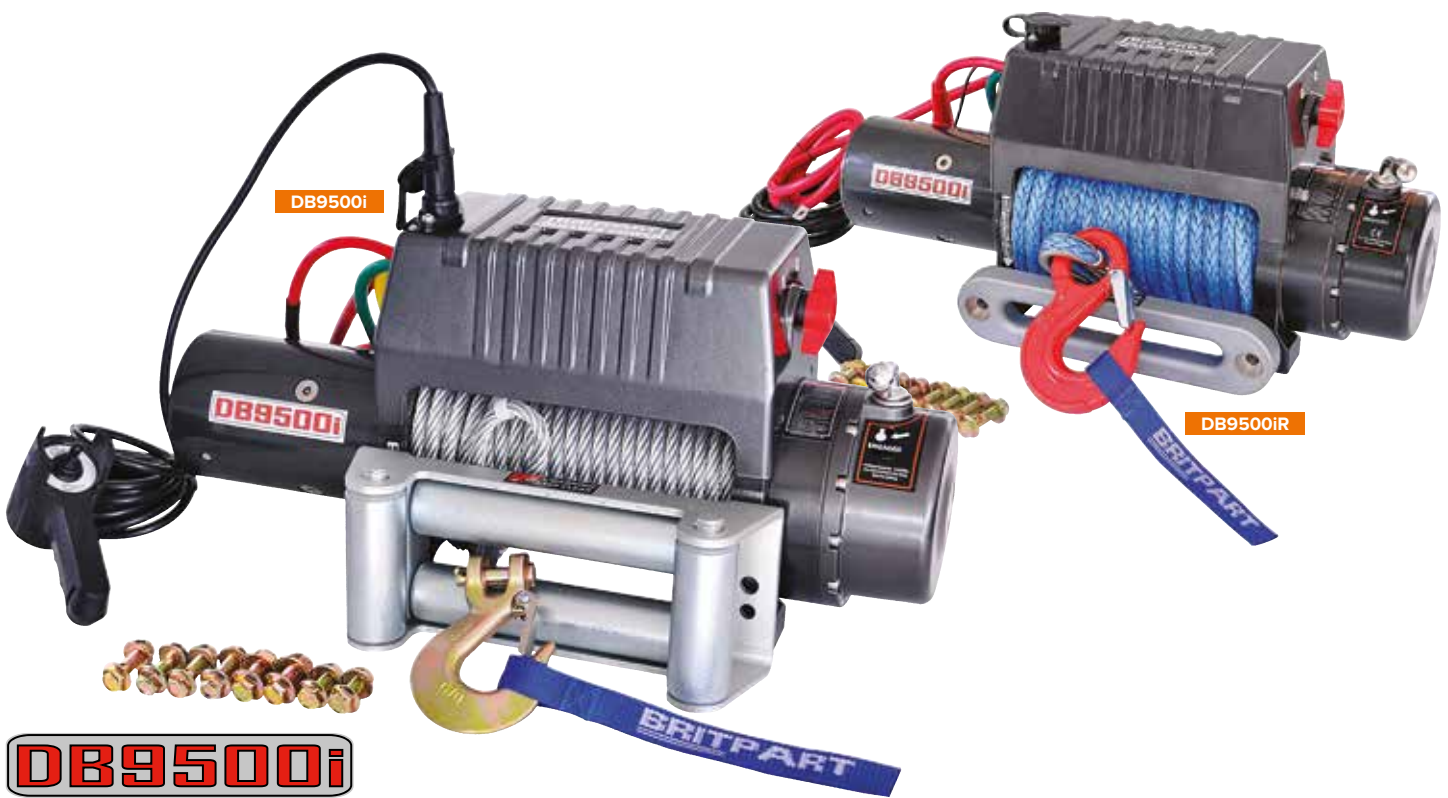

DB9500i

Performance of 1st Layer								Line Pull & Cable/Rope Capacity by Layer							
Line Pull		Line Speed				Motor Current		Rope Layer	Rated Line Pull		Rope Capacity				
		12 volt		24 volt		12 volt	24 volt				Steel Cable		Dyneema Rope		
Lbs	Kg	Fpm	Mpm	Fpm	Mpm	Amp	Amp	Lbs	Kg	Feet	Meters	Feet	Meters		
0	0	19.0	5.8	22.5	6.9	110	85	1	9,500	4,309	15.0	5.0	13.8	4.2	
4,000	1,816	12.5	3.8	14.8	4.5	210	145	2	7,500	3,402	38.0	11.5	31.2	9.5	
6,000	2,724	10.5	3.2	12.5	3.8	260	190	3	6,200	2,812	64.0	19.5	51.5	15.7	
8,000	3,632	8.6	2.6	10.5	3.2	300	220	4	5,300	2,404	95.0	29.0	76.4	23.3	
9,500	4,313	7.9	2.4	9.2	2.8	350	275	5	4,630	2,100	100.0	30.5	91.9	28.0	

Galvanised aircraft cable with break force - 14,400lbs
DB9500i Britpart 9,500lbs winch 12 volt
DB9500i24 Britpart 9,500lbs winch 24 volt

Dyneema rope with break force - 25,800lbs
DB9500iR Britpart 9,500lbs winch 12 volt

> Winching

Winches - continued



DB9000CR



DB9000C

DB9000C

IMPORTANT
When fitting a winch to a Defender don't forget to order the extended winch wiring kit with cut-off switch.
Part number **DB1014**



Performance of 1st Layer					Line Pull & Cable/Rope Capacity by Layer						
Line Pull		Line Speed		Motor Current	Rope Layer	Rated Line Pull		Rope Capacity			
Lbs	Kg	Fpm	Mpm	Amp		Lbs	Kg	Steel Cable		Dyneema Rope	
								Feet	Meters	Feet	Meters
0	0	9.8	3.0	50	1	9,000	4,309	15.0	5.0	12.8	3.9
2,000	907	9.8	3.0	120	2	7,500	3,402	38.0	11.5	29.2	8.9
4,000	1,814	8.9	2.7	170	3	6,200	2,812	64.0	19.5	49.0	15.0
6,000	2,722	8.2	2.5	225	4	5,300	2,404	95.0	29.0	71.9	21.9
8,000	3,629	7.2	2.2	275	5	4,630	2,100	100.0	30.5	91.9	28.0
9,000	4,086	6.1	1.9	300							

Galvanised aircraft cable with break force - 14,400lbs
DB9000C
Britpart 9,000lbs winch 12 volt

Dyneema rope with break force - 25,800lbs
DB9000CR
Britpart 9,000lbs winch 12 volt

DB6000

DB6000



Performance of 1st Layer					Line Pull & Cable Capacity by Layer						
Line Pull		Line Speed		Motor Current	Rope Layer	Rated Line Pull		Rope Capacity			
Lbs	Kg	Fpm	Mpm	Amp		Lbs	Kg	Steel Cable		Dyneema Rope	
								Feet	Meters	Feet	Meters
0	0	15.0	4.6	30	1	6,000	2,722	12.7	3.9		
1,000	454	11.5	3.5	80	2	5,000	2,268	27.5	8.4		
3,000	1,361	9.0	2.7	120	3	4,250	1,928	44.0	13.4		
5,000	2,268	7.0	2.0	170	4	3,720	1,687	64.0	19.5		
6,000	2,722	4.9	1.5	210	5	3,300	1,497	85.0	25.9		

Galvanised aircraft cable with break force - 10,000lbs
DB6000
Britpart 6,000lbs winch 12 volt



Photo courtesy of Bogdan Muscalu

Winches - continued



Britpart DB2000 fitted to a working model of a Land Rover

DB2000

Performance of 1st Layer					Line Pull & Rope Capacity by Layer				
Line Pull		Line Speed		Motor Current	Rope Layer	Rated Line Pull		Rope Capacity	
Lbs	Kg	Fpm	Mpm	Amp		Lbs	Kg	Feet	Meters
0	0	14.0	4.3	14					
1,000	454	9.0	2.7	60	1	2,000	907	6.0	1.8
1,500	680	7.5	2.3	90	2	1,636	742	13.0	4.0
2,000	907	5.9	1.8	115	3	1,385	628	22.0	6.7
					4	1,200	544	33.0	10.0
					5	1,059	480	44.0	13.4
					6	947	430	50.0	15.2

Cable with break force - 4,000lbs
DB2000
 Britpart 2,000lbs winch 12 volt
 Includes tension plate to prevent rope entanglement

Important
 Winch suitable for small vehicles and trailer applications only.

Winch Spare Parts

	DB12000i	DB9500i	DB9000C	DB8000	DB6000	DB2000
Winch motor	DB1300	DB1300	DB1332	DB1301	DB1337	N/A
Solenoid assembly	DB1303	DB1303	DB1302	DB1302	DB1336	N/A
Brake service kit	DB1304	DB1304	DB1304	N/A	DB1338	N/A
Roller fairlead	DB1307 180mm aperture	DB1307 180mm aperture	DB1307 180mm aperture	DB1307 180mm aperture	DB1341 105mm aperture	N/A
Winch cable & hook	DB1328	DB1328	DB1328	DB1328	DB1339	DB1354
Winch cable hook	DB1328H	DB1328H	DB1328H	DB1328H	N/A	
Brush & holder set	DB1330	DB1330	DB1331	DB1331	DB1340	N/A
Remote control	DB1327 - rocker - 3-pin DB1355 - rocker - 4-pin DB1334 - toggle - 3-pin	DB1327 - rocker - 3-pin DB1355 - rocker - 4-pin DB1334 - toggle - 3-pin	DB1327 - rocker - 3-pin DB1355 - rocker - 4-pin DB1334 - toggle - 3-pin	DB1327 - rocker - 3-pin DB1355 - rocker - 4-pin DB1334 - toggle - 3-pin	DB1355 - rocker - 4-pin DB1334 - toggle - 3-pin	DB1343
Remote control socket upgrade kit From 15mm to 20mm with remote control.	NEW DB1356 - rocker - 4-pin DB1352 - toggle - 3-pin	NEW DB1356 - rocker - 4-pin DB1352 - toggle - 3-pin	NEW DB1356 - rocker - 4-pin DB1352 - toggle - 3-pin	NEW DB1356 - rocker - 4-pin DB1352 - toggle - 3-pin	NEW DB1356 - rocker - 4-pin DB1352 - toggle - 3-pin	N/A
Remote control socket upgrade/repair From 15mm to 20mm	DB1352R - 3-pin DB1355R - 4-pin Can also be used to repair existing 20mm socket	DB1352R - 3-pin DB1355R - 4-pin Can also be used to repair existing 20mm socket	DB1352R - 3-pin DB1355R - 4-pin Can also be used to repair existing 20mm socket	DB1352R - 3-pin DB1355R - 4-pin Can also be used to repair existing 20mm socket	DB1352R - 3-pin DB1355R - 4-pin Can also be used to repair existing 20mm socket	N/A



For more images of the winch spare parts - www.britpart.com/winchparts

Winch Bumpers



Winch Bumper Kits



Britpart have all the kits you need to help you to get winching.

Defender winch bumper kits all include the extended wiring kit including safety cut-off switch kit (DB1014)

Standard Bumper

DB1313	Defender - non air-con	Steel Cable	DB12000i winch
DB1313R	Defender - non air-con	Dyneema Rope	DB12000i winch
DB1344	Defender - air-con	Steel Cable	DB12000i winch
DB1344R	Defender - air-con	Dyneema Rope	DB12000i winch
DB1310	Defender - non air-con	Steel Cable	DB9500i winch
DB1310R	Defender - non air-con	Dyneema Rope	DB9500i winch
DB1345	Defender - air-con	Steel Cable	DB9500i winch
DB1345R	Defender - air-con	Dyneema Rope	DB9500i winch
DB1313-24V	Defender - non air-con	Steel Cable	DB12000i winch - 24 volt
DB1325	Discovery 1/Range Rover Classic	Steel Cable	DB12000i winch
DB1325R	Discovery 1/Range Rover Classic	Dyneema Rope	DB12000i winch
DB1324	Discovery 1/Range Rover Classic	Steel Cable	DB9500i winch
DB1324R	Discovery 1/Range Rover Classic	Dyneema Rope	DB9500i winch
Note - DB1324, DB1325, DB1324R& DB1325R are for vehicles without air-con and/or without transmission oil coolers fitted.			
DB1346	Discovery 2	Steel Cable	DB12000i winch
DB1346R	Discovery 2	Dyneema Rope	DB12000i winch
DB1347	Discovery 2	Steel Cable	DB9500i winch
DB1347R	Discovery 2	Dyneema Rope	DB9500i winch

Galvanised Standard Bumper

DB1313GALV	Defender - non air-con	Steel Cable	DB12000i winch
DB1313RGALV	Defender - non air-con	Dyneema Rope	DB12000i winch
DB1310GALV	Defender - non air-con	Steel Cable	DB9500i winch
DB1310RGALV	Defender - non air-con	Dyneema Rope	DB9500i winch

Tubular Bumper

DB1319	Defender - non air-con	Steel Cable	DB12000i winch
DB1319R	Defender - non air-con	Dyneema Rope	DB12000i winch
DB1321	Defender - air-con	Steel Cable	DB12000i winch
DB1321R	Defender - air-con	Dyneema Rope	DB12000i winch
DB1348	Defender - non air-con	Steel Cable	DB9500i winch
DB1348R	Defender - non air-con	Dyneema Rope	DB9500i winch
DB1349	Defender - air-con	Steel Cable	DB9500i winch
DB1349R	Defender - air-con	Dyneema Rope	DB9500i winch
DB1320	Discovery 1	Steel Cable	DB12000i winch
DB1320R	Discovery 1	Dyneema Rope	DB12000i winch
DB1350	Discovery 1	Steel Cable	DB9500i winch
DB1350R	Discovery 1	Dyneema Rope	DB9500i winch

Note - DB1320, DB1350, DB1320R & DB1350R the grille needs trimming for fitting to air-con & automatic vehicles.

Standard Bumper



Standard Galvanised Bumper



Tubular Bumper

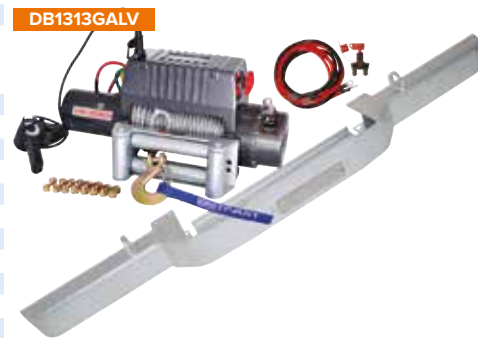

Tamper Proof Nuts & Bolts



Ensure your precious accessories remain firmly on your Land Rover by using a set of these tamper proof nuts and bolts. Ideal for securing your winch and front bumper. Each set contains either 4 nuts or bolts and 1 key.

DA7330	M6 nut set & key
DA7331	M8 nut set & key
DA7332	M10 nut set & key
DA7333	M10 x 110 bolt set & key
DA7334	M10 x 35 bolt set & key



Winch Bumpers

Tubular winch bumpers

- > Stylish tubular steel space-frame construction for strength
- > Extremely close fitting for maximum approach angle
- > Compatible with many steering guards
- > Built-in high-lift jacking points
- > Integral rock guard
- > Supplied with full fitting kit

Note - Grille will need modifying

DA5609 Defender - air-con
Suitable for DB12000i, DB9500i & DB9000C winches

DA5622 Defender - non air-con
Suitable for DB12000i, DB9500i & DB9000C winches

DA5604 Discovery 1
Suitable for DB12000i, DB9500i & DB9000C winches

Note - Grille needs trimming for fitment to air-con & automatic vehicles

Standard winch bumpers

- > Heavy-duty steel winch bumpers

DA5620 Defender - non air-con Black
Suitable for DB12000i, DB9500i & DB9000C winches

DA5681 Defender - non air-con Galvanised
Suitable for DB12000i, DB9500i & DB9000C winches

DA5623 Defender - air-con
Suitable for DB12000i, DB9500i & DB9000C winches

DA5643 Defender - air-con
Suitable for Warn 9000 and 9.5 Series winches

DA5621 Discovery 1/Range Rover Classic

Note - For vehicles without air-con and/or without transmission oil coolers fitted
Suitable for DB12000i, DB9500i & DB9000C winches

DA5645 Discovery 2

- > One piece bumper manufactured from 5mm steel with wrap around sides to protect the wings
- > Fixed to standard mounting points with provisions for 2 swivel recovery points and 2 Hi-Lift jacking points

Note - Grille needs trimming to fit winch

Suitable for DB12000i, DB9500i & DB9000C winches

A range of winch bumpers to suit your Land Rover

Discreet winch bumpers

- > Suitable for any low line winch
- > Made from 6mm and 8mm steel
- > Discreetly fits behind the existing bumper
- > Bolts directly onto the front cross member using existing holes
- > Modifications to bumper are required, includes instructions
- > Excludes fairlead

Note - Low line winch needs to have a removable solenoid. Use DB9000 - solenoid needs to be removed and relocated.

DA7537 Discovery 3 - TdV6/Discovery 4 - TdV6/Range Rover Sport - TdV6

DA7538 Range Rover Sport - 3.6 TdV8, 4.2 V8 Supercharged, 4.4 V8



Winch and A-bar not included



DA1171K



DA1171



ALQ710020K

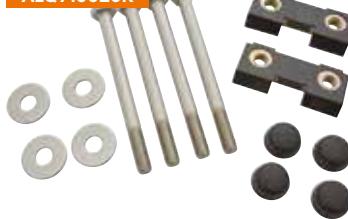

Defender Bumper Fitting Kits

DA1171K
Easier fitment plates which replace the standard fitted spring clip plates. With stainless steel bolt set.

DA1171
Easier fitment plates which replace the standard fitted spring clip plates. Without bolt set.

ALQ710020K
Tapping blocks & stainless steel bolt set

DA1269
Tapping blocks & bumper bolt kit

DA1268
Bumper bolt kit

DA5621K
Discovery 1/Range Rover Classic Replacement fitting kit for winch bumper - DA5621

DA5621K



DA5699



Number Plate Bracket

DA5699
Universal number plate mounting bracket 405mm wide x 110mm deep. Number plate not included.

Winch Accessories

Fairleads



DB1307



DB1316

255mm Mounting holes

DB1003	Hawse fairlead	Steel	215mm aperture
DB1004	Hawse fairlead	Steel	130mm aperture
DB1315	Hawse fairlead	Aluminium	205mm aperture
DB1317	Hawse fairlead	Stainless steel	205mm aperture
DB1316	Roller fairlead	Stainless steel	180mm aperture
DB1307	Roller fairlead	Zinc coated	180mm aperture
DB1341	Roller fairlead	Zinc coated	105mm aperture

125mm Mounting holes

DB1005	Hawse fairlead	Steel	80mm aperture
--------	----------------	-------	---------------



DB1317



DB1315



DB1003



DB1004



DB1005

Ropes & Straps



DA3034



DB1007

DA3033	Tree strap	1.5t SP	4m x 90mm
DA3034	Tree strap	1.5t SP	6m x 90mm
DB1007	Tree strap	4t SP	1.6m x 120mm
DB1006	Tow strap	8t WLL	9m x 60mm
DB1011	High elasticity tow sling	8t WLL	9m x 60mm
DA3028	Rope - polypropylene	8t MBL	5m x 24mm
DA3029	Rope - nylon	12t MBL	5m x 24mm
DA3030	Kinetic recovery rope - octoplat	12t MBL	5m x 24mm
DA3031	Kinetic recovery rope - octoplat	12t MBL	8m x 24mm

Note - SP = straight pull; WLL = working load limit; MBL = maximum breaking load



DB1006



DB1011



DA3028



DA3030



DA1278

2 Ton Flat Webbing Sling - Green

This soft and light polyester product reduces the chance of damage during use. The reinforced eyes make the sling both secure and reliable. Tested on a 7:1 breaking strain factor, this flat webbing sling ensures that the item is safe to lift a weight of 2 ton or less. Sling will come with the safe load limit, date of manufacture, serial number and test certification.

	Length	Width	Breaking Strain
DA1278	3,000mm	60mm	2,000kg
DA1279	5,000mm	60mm	2,000kg



DA1281

3 Ton Flat Webbing Sling - Yellow

Crafted from polyester to give you a lighter alternative to chain and rope solutions. They are easy to pack away and store, making your life that little bit easier! The sling is coloured in line with EU safety standards with yellow representing a 3 ton loading limit. These webbing slings have been carefully tested on a 7:1 breaking stress factor to confirm that they can safely handle the 3 ton safe loading limit. Sling will come with the safe load limit, date of manufacture, serial number and test certification.

	Length	Width	Breaking Strain
DA1280	3,000mm	90mm	3,000kg
DA1281	4,000mm	90mm	3,000kg
DA1282	6,000mm	90mm	3,000kg



DA1283

Tow Strap - Loop and Loop - Orange

Flat polyester tow strap is lighter than chain and rope equipment, giving you the flexibility to take it with you wherever you go. It is ideal for towing and pulling vans, caravans, cars and agricultural vehicles.

	Length	Width	Breaking Strain
DA1283	8,000mm	50mm	5,000kg

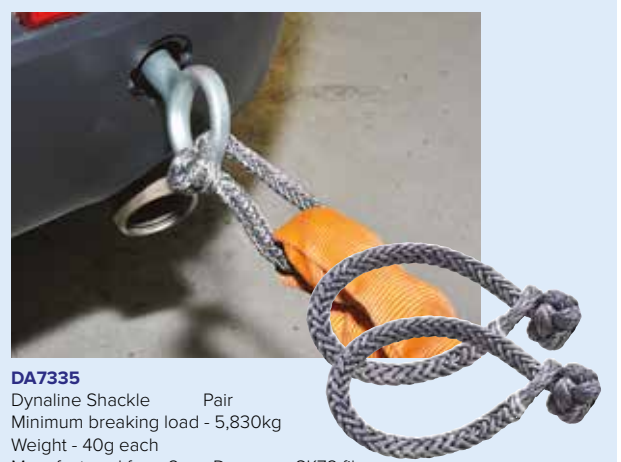

Photo courtesy of Darren Whiley

Shackles & Pulleys



- DA3160** Swivel recovery eye - stainless steel - 36mm diameter & shackle (3.25 tons)
Note - Not suitable for standard Land Rover bumpers
- DA3160A** Replacement shackle for DA3160
- DB1009** Shackle - 1.4 ton
- DB1353** 'D' shackle - 1.4 ton
- DB1012** Shackle - 4.7 ton
- DB1322** Swivel shackle
- DB1323** Non-forged jate ring
- DB1329** Forged jate ring
- DB1008** Pulley hook - SWL loads - Pulling - 1,500kgs / Lifting - 750kgs
- DB1002** Snatch block



DA7335
 Dynaline Shackle Pair
 Minimum breaking load - 5,830kg
 Weight - 40g each
 Manufactured from 8mm Dyneema SK78 fibre.
 The lightweight, easy and safe way of joining ropes and strops. Due to the much lower kinetic energy being stored, using this Dynaline shackle is much safer in the event of a rope or strop failure. Can also be used to attach ropes to standard towing eyes without scratching the paintwork. See how easy it is to use this shackle at - www.britpart.com/DA7335

More product images at www.britpart.com



Oops!...
 "Glad I've got that Britpart winch"



DA8995
 ARB Snatch Block
 Feature side plates that sit snug against the pulley, eliminating the possibility of the winch cable becoming trapped between the pulley and the side plates. The groove on the pulley itself tapers down to the centre allowing for a variety of cable sizes (1/4"-1/2") to be used and ensures the cable is seated securely in the pulley, minimizing lateral movement.

- Features**
- > Works with steel or synthetic winch lines
 - > Light weight design
 - > Easy to use
 - > Doubles the capacity of your winch
 - > Allows winching from awkward angles
 - > Engineered tough for serious recovery
 - > Suits vehicle mounted and portable winches
 - > Vehicle recovery booklet enclosed

Specifications

Working load:	9,000kg (20,000lbs)
Breaking strength:	17,500kg (38,500lbs)
Side plate material:	6mm cold rolled steel
Pulley material:	Specialized polymer
Pulley diameter:	110mm (4.3")
Cable size:	8mm - 13mm (0.3"-0.5")
Weight:	2.4kg (5.3lbs)
Greasable:	Not required

> Winching

Safety Equipment

DA2037	Universal battery isolator switch
DA2037KY	Replacement isolator switch key for DA2037
DA3156	Winch In Safety - A5 guide from Land Rover
DB1000	Wheel chocks - pair
DB1010	Gloves - for protection winch operation
DB1016	Winch blanket - manufactured from heavy-duty vinyl, the blanket will absorb most of the recoil in the unlikely event of the cable breaking. It's also very useful to kneel on in the mud!

Winch Remote Control

DB1308	12 volt remote
DB1308-24V	24 volt remote

Operate your winch from a safe distance with this wireless remote control

- > High frequency circuit using SMD design for reliability
- > The transmitter uses FM technology for frequency stability and greater control distance
- > Receiver output is protected against voltage spikes



Winch with safety in mind

Winching Accessory Kits



Britpart Pulling Power winching recovery kits come with all the basic items needed to ensure your winch can be used to the best effect. There is a choice of a starter or professional kit depending on your needs.

DB1015

1 x DB1000	Wheel chocks (pair)
1 x DB1001	Winch kit bag
1 x DB1002	Snatch block - 9,000kgs
1 x DB1006	Tow strap - 8 ton, 60mm x 9m
1 x DB1007	Tree strop
1 x DB1010	Winching gloves
1 x DB1011	Snatch tow sling - 8 ton
2 x DB1012	Alloy bow shackle - 4.75 ton
1 x DB1016	Winching blanket

DB1017

1 x DB1001	Winch kit bag
1 x DB1002	Snatch block - 9,000kgs
1 x DB1006	Tow strap - 8 ton, 60mm x 9m
1 x DB1007	Tree strop
1 x DB1010	Winching gloves
2 x DB1012	Alloy bow shackle - 4.75 ton

DB1017P

1 x DB1001	Winch kit bag
1 x DB1002	Snatch block - 9,000kgs
1 x DB1007	Tree strop
1 x DB1010	Winching gloves
2 x DB1012	Alloy bow shackle - 4.75 ton
2 x DB1329	Jate rings

Other Essential Winching Accessories

DB1309 'Dyneema Bowrope'
12 strand synthetic fibre replacement winch rope - 11mm x 28m
Breaking point - 25,800lbs

- > For use with DB9000C, DB9500i and DB12000i winches
- > Very light
- > Easily spliced
- > Highly visible
- > Less effort in use
- > Very strong
- > Does not curl
- > Compact
- > Safety in use
- > Easy to handle
- > Floats
- > Does not kink

DB1328	Replacement winch cable with hook - 30.5m x 9.5mm Suitable for DB12000/DB9500/DB9000C
DB1339	Replacement winch cable with hook - 26.0m x 8mm Suitable for DB6000
DB1354	Replacement winch cable with hook - 15.2m x 4mm Suitable for DB2000
DB1001	Winch bag - a heavy-duty bag
DB1014	Extended winch wiring kit - 1 x red, 1 x black wire, each 1.8m in length with end connectors and cut-off switch for Defender vehicles Ground anchor
DA6541	Pull yourself out of trouble with this heavy-duty ground anchor. This anchor utilises a Hi-Lift jack (not included).
DB1314	Ground anchor set - 600mm pins
DB1318	Ground anchor bag set - 2 x Pulling Power bags Note - ground anchor not included (DA1314)

DA8904
ARB's winch pack is designed to fit a complete recovery kit including snatch strap, tree trunk protector, winch extension strap, snatch block, recovery damper, bow shackles and gloves. The winch pack is sold individually and does not come stocked with the straps. All items sold separately so the user can select the correct strap weights for their vehicle.



Performance

Make your Land Rover even more special by upgrading from its standard specification to something a bit more unique. An extensive selection of braking equipment to air filters and tuning boxes means that there is something to suit every Land Rover to help improve its performance.

Braking

Anti-squeal shims.....	110
Brake discs - Britpart Performance.....	110
Brake discs - EBC.....	111
Brake hose kits.....	113
Brake lubrication.....	110
Brake pads - DTEC.....	113
Brake pads - EBC.....	111 - 112
Handbrake conversion kits.....	114

Engine

Air filters - Britpart Performance.....	116
Air filters - K&N.....	117
Aluminium header tanks.....	118
EGR blanking & silicone hose kits.....	115
EGR blanking kits & tubes.....	115
Electronic fan kits.....	119
Filter guards.....	115
Intercoolers - performance.....	117
Powerlite starter motors & Dynalite alternator.....	119
PSI power tuning products.....	120
Silicone hose kits.....	118
Tuning box.....	120
Tunit.....	120
Turbo boost box.....	121
Upgrade chips.....	120
Weber carburettors.....	121

Exhausts

Double 'S' stainless steel exhausts.....	122 - 123
Exhaust clamps.....	123
Exhaust fitting kits.....	122
Front downpipes.....	121
Stainless steel exhaust.....	121
Utility link pipes & rear silencers.....	124

Transmission

.....	125
-------	-----



Braking

Britpart Performance Brake Discs



- > Slotted design to increase braking efficiency by reducing dust, debris, water and gas on the disc.
- > To improve brake cooling, reduce weight and to offer an escape route for dirt and gasses these performance discs are drilled with rows of holes.
- > Excellent upgrade for your Land Rover to aid braking, especially under a heavy load.
- > Ideal for off-road use.
- > Manufactured to British Standard BS1452 Grade 220 and DIN1691 GG20.
- > Supplied in pairs.

Quality performance brake discs.

IMPORTANT BRAKE INFORMATION

For exact change over points with vehicle applications please contact your local Britpart distributor with the full chassis number for the correct application. These references are intended as a guide only.

Defender	Corresponds to			
DA4600	LR017951/FRC7329	Defender - 1987 - 2006 & 2007 onwards	Front	Solid
DA4602	LR017952/FTC902	Defender - 1987 - 2006 & 2007 onwards	Front	Vented
DA4601	LR017953/FTC1381	Defender - 1987 - 2006 & 2007 onwards	Rear	Solid
DA4605	LR018026/SDB000330	Defender - 1987 - 2006 & 2007 onwards	Rear	Solid

Discovery				
DA4600	LR017951/FRC7329	Discovery 1	Front	Solid
DA4602	LR017952/FTC902	Discovery 1	Front	Vented
DA4601	LR017953/FTC1381	Discovery 1	Rear	Solid
DA4606	SDB000380	Discovery 2	Front	Vented
DA4604	SDB000470	Discovery 2	Rear	Solid
DA4611	SDB000614	Discovery 3	Front	Vented
DA4612	SDB000604	Discovery 3	Front	Vented
DA4613	SDB000646	Discovery 3	Rear	Vented
DA4614	SDB000636	Discovery 3	Rear	Vented
DA4624	SDB000624	Discovery 4	Front	Vented
DA4612	SDB000604	Discovery 4	Front	Vented
DA4613	SDB000646	Discovery 4	Rear	Vented
DA4614	SDB000636	Discovery 4	Rear	Vented
DA4689	LR059122	Discovery Sport	Front	Vented
DA4690	LR061388	Discovery Sport	Rear	Solid

Freelander				
DA4607	SDB100830	Freelander 1 - up to YA999999	Front	Solid
DA4608	SDB101070	Freelander 1 - 1A000001 onwards	Front	Vented
DA4617	LR000470/LR027107	Freelander 2 - petrol	Front	Vented
DA4615	LR001019	Freelander 2 - petrol	Rear	Vented
DA4618	LR007055	Freelander 2 - diesel	Front	Vented
DA4616	LR001018	Freelander 2 - diesel	Rear	Solid
DA4688	LR039935	Freelander 2	Rear	Solid

Range Rover				
DA4600	LR017951/FRC7329	Range Rover Classic - 1986 - 1991	Front	Solid
DA4602	LR017952/FTC902	Range Rover Classic - 1986 - 1994	Front	Vented
DA4601	LR017953/FTC1381	Range Rover Classic - 1986 - 1994	Rear	Solid
DA4603	NTC8780	Range Rover P38 - 1995 - 2002	Front	Vented
DA4604	SDB000470	Range Rover P38 - 1995 - 2002	Rear	Solid
DA4611	SDB000614	Range Rover Sport - 2005 - 2009	Front	Vented
DA4612	SDB000604	Range Rover Sport - 2005 - 2009	Front	Vented
DA4624	SDB000624	Range Rover Sport - 2005 - 2013	Front	Vented
DA4613	SDB000646	Range Rover Sport - 2005 - 2013	Rear	Vented
DA4614	SDB000636	Range Rover Sport - 2005 - 2009	Rear	Vented
DA4628	LR016192	Range Rover Sport - 2010 - 2013	Rear	Vented
DA4627	LR016176	Range Rover Sport - 2014 onwards	Front	Vented
DA4685	LR038934	Range Rover Sport - 2014 onwards	Front	Vented
DA4686	LR033303	Range Rover Sport - 2014 onwards	Rear	Vented
DA4687	LR033302	Range Rover Sport - 2014 onwards	Rear	Vented
DA4609	SDB000201	Range Rover L322	Front	Vented
DA4619	SDB500182	Range Rover L322	Front	Vented
DA4622	LR031843/SDB500193	Range Rover L322	Front	Vented
DA4610	SDB000211	Range Rover L322	Rear	Solid
DA4623	LR017804/LR031844/SDB500202/SDB500201	Range Rover L322	Rear	Vented
DA4625	LR011591	Range Rover L322 - 2010 - 2012	Front	Vented
DA4627	LR016176	Range Rover L322 - 2010 - 2012	Front	Vented
DA4626	LR011891/LR031846	Range Rover L322 - 2010 - 2012	Rear	Vented
DA4627	LR016176	Range Rover L405	Front	Vented
DA4685	LR038934	Range Rover L405	Front	Vented
DA4686	LR033303	Range Rover L405	Rear	Vented
DA4687	LR033302	Range Rover L405	Rear	Vented
DA4618	LR007055	Range Rover Evoque	Front	Vented
DA4689	LR059122	Range Rover Evoque - 17"	Front	Vented
DA4683	LR027123	Range Rover Evoque	Rear	Solid

Sign up to the regular Britpart newsletter to find out about all the latest product releases.
www.britpart.com/newsletter

Anti-squeal Shims



DA1141
 Pack of 4. Universal self adhesive noise dampening shims.

The shims are manufactured from wolverine and cut to shape and applied to the backing plate of the brake pads prior to fitting to help eliminate any noise issues (should the pad be unshimmed). When used in conjunction with Mintex CeraTec silicon based lubricant, most brake noise related issues will be eradicated.

Brake Lubrication

DA2389
 75ml

Cera-Tec Advanced Lubricant
 Mintex Cera-Tec is an advanced non-metallic universal lubricant that provides many benefits over traditional copper-based grease.

- > Non-metallic content - ABS and ESP friendly.
- > Operates to a high temperature (1,000°C).
- > Non-conductive.
- > Free of copper and acid.
- > More effective at reducing any brake squeal.
- > Protects against corrosion and dirt.
- > Neutral colour prevents any visible residue or staining.



EBC Brake Discs

Defender	Corresponds to				
DA4165	LR017951/FRC7329	Defender - 1987 - 2006 & 2007 onwards	Front	Solid	
DA4151	LR017952/FTC902	Defender - 1987 - 2006 & 2007 onwards	Front	Vented	
DA4152	LR017953/FTC1381	Defender - 1987 - 2006 & 2007 onwards	Rear	Solid	
DA4855	SDB000330	Defender - 1987 - 2006 & 2007 onwards	Rear	Solid	
Discovery					
DA4165	LR017951/FRC7329	Discovery 1	Front	Solid	
DA4151	LR017952/FTC902	Discovery 1	Front	Vented	
DA4152	LR017953/FTC1381	Discovery 1	Rear	Solid	
DA4158	SDB000380	Discovery 2	Front	Vented	
DA4148	SDB000470	Discovery 2	Rear	Solid	
DA4187	SDB000614	Discovery 3	Front	Vented	
DA4475	SDB000604	Discovery 3	Front	Vented	
DA4188	SDB000646	Discovery 3	Rear	Vented	
DA4473	SDB000636	Discovery 3	Rear	Vented	
DA4496	SDB000624	Discovery 4	Front	Vented	
DA4475	SDB000604	Discovery 4	Front	Vented	
DA4188	SDB000646	Discovery 4	Rear	Vented	
DA4473	SDB000636	Discovery 4	Rear	Vented	
Freelander					
DA4477	SDB101070	Freelander 1 - 1996 from 1A000001	Front	Vented	
DA4551	LR000470/LR027107	Freelander 2 - petrol	Front	Vented	
DA4549	LR001019	Freelander 2 - petrol	Rear	Vented	
DA4552	LR007055	Freelander 2 - diesel	Front	Vented	
DA4550	LR001018	Freelander 2 - diesel	Rear	Solid	
Range Rover					
DA4165	LR017951/FRC7329	Range Rover Classic - 1986 - 1991	Front	Solid	
DA4151	LR017952/FTC902	Range Rover Classic - 1986 - 1994	Front	Vented	
DA4152	LR017953/FTC1381	Range Rover Classic - 1986 - 1994	Rear	Solid	
DA4147	NTC8780	Range Rover P38 - 1995 - 2002	Front	Vented	
DA4148	SDB000470	Range Rover P38 - 1995 - 2002	Rear	Solid	
DA4187	SDB000614	Range Rover Sport - 2005 - 2009	Front	Vented	
DA4475	SDB000604	Range Rover Sport - 2005 - 2009	Front	Vented	
DA4496	SDB000624	Range Rover Sport - 2005 - 2009 & 2010 - 2013	Front	Vented	
DA4188	SDB000646	Range Rover Sport - 2005 - 2013	Rear	Vented	
DA4473	SDB000636	Range Rover Sport - 2005 - 2009	Rear	Vented	
DA4474	SDB000201	Range Rover L322	Front	Vented	
DA4476	SDB500193	Range Rover L322	Front	Vented	
DA4856	SDB500182	Range Rover L322	Front	Vented	
DA4472	SDB000211	Range Rover L322	Rear	Solid	
DA4488	LR017804/LR031844	Range Rover L322	Rear	Vented	
DA4552	SDB500202/SDB500201	Note - not dimpled or slotted			
DA4552	LR007055	Range Rover Evoque	Front	Vented	
DA4554	LR027123	Range Rover Evoque	Rear	Solid	

EBC Brake Discs

- > Sold in pairs.
- > 100% British cast and machined high quality product.
- > Wide aperture slots that draw cool air under the pad surface.
- > Slots that expel all dirt dust and debris from the braking area.
- > Blind drilled dimples that eliminate cracking common with through drilled sport rotors whilst helping maintain perfect pad contact.

IMPORTANT BRAKE INFORMATION

For exact change over points with vehicle applications please contact your local Britpart distributor with the full chassis number for the correct application. These references are intended as a guide only.



EBC BRAKES

EBC Ultimax Heavy-duty Brake Pads

- > New AF42/66 friction material which completely eliminates brake judder and produces a high friction long lasting brake pad.
- > Unique powder coat finish to both pad and back plate gives lifetime resistance to corrosion and prevents moisture ingress.
- > Unique Brake-In surface coating provides instant brake efficiency on installation and conditions the brake rotor removing glaze, black spotting etc from disc surface.
- > All pads feature centre line slot which prevents heat expansion cracks and reduces brake noise.
- > All pads feature edge chamfers which have major technical benefits;
 - Significant reduction in brake noise
 - Prevents 'edge lifting' under left and right extremities of pad which can cause corrosion ingress and eventual pad de-bond
 - Can extend pad life by virtue of improved pad efficiency
- > Most pads in the Ultimax range features factory fitted noise reduction shims.



EBC Green Stuff High Performance Brake Pads

- > 100% British design and manufacture.
- > Superb gloss powder coat paint finish to reduce corrosion.
- > Unique engineering finish with noise reduction slots and edge chamfers.
- > Extra high friction compounds for better stops, these pads will improve your stopping power by up to three vehicle lengths.
- > Special compound ingredients that prevent "Outline Etching" eliminating brake stiction onto the rotor in damp conditions.
- > Unique "Brake-In" surface coating to accelerate pad bed in after installing new pads which also guarantees brake efficiency from installation.
- > Super quiet braking with rubber-steel-rubber noise reduction shims on the reverse, this dampens all possible noise.
- > Extra heavy duty compound lasts longer than low cost standard pads.
- > Fully ECE R 90 approved and legal for road and off road use.



For full range of EBC brake pads - see overleaf

EBC Yellow Stuff Performance Race Brake Pads

- > High friction compound which is effective from cold up to high heat.
- > Effective brake upgrade for heavy-duty braking.
- > Long lasting powerful brakes.
- > Shims, edge chamfers and slots for silent braking.



EBC Yellowstuff brake pads are British made and contain Aramid fibres. These are man-made high performance fibres, used widely for their light-weight, high strength, abrasion resistance and thermal stability. These properties provide advantages over cheaper steel fibre based products. Not only high in friction from first application when brakes are cold but extremely effective at higher brake temperatures as encountered in faster driving and towing/trailing. These pads are a favourite with the military and are used on armoured vehicles in several countries to handle the higher loads and heat and offer a good brake upgrade. Fitted with shims chamfers, centre slots and the unique EBC Brake in coating for fast bedding in of new brakes these pads are also long lasting and silent in operation.

EBC Brake Pads



			Cross Reference 1	Cross Reference 2	Cross Reference 3	Vehicle	Fitment
Defender							
DA3310*	DA4159	DA4560	SFP000260	STC2952		Defender 110 - from 1986	Front
DA3313*	DA4185		SFP000280	SFP000160	STC1601	Defender 110 - from 1994	Rear
DA3308*			STC2950			Defender 110 - up to 1986	Front
DA3311*	DA4157		SFP500160	STC9191		Defender 90 - 1986 - 1991	Front
DA3310*	DA4159	DA4560	SFP000260	STC2952		Defender 90 - from 1991	Front
DA3318	DA4485	DA4849	SFP000270			Defender 90 - from 1994	Rear
	DA4154		SFP500200	STC9189		Defender 90 - from 1994	Rear
DA3307	DA4153		SFP500220	STC9187	STC9186	Defender 90 - up to 1986	Front
Discovery							
DA3312*	DA4156	DA4842	SFP500180	STC9190		Discovery 1	Front
DA3311*	DA4157		SFP500160	STC9191		Discovery 1 - from 1994	Front
DA3309*			SFP500220	STC9187		Discovery 1 - up to 1993	Front
DA3319*	DA4154	DA4850	SFP500200	STC9189		Discovery 1 - with sensor	Rear
DA3318	DA4485		SFP000270			Discovery 1 - without sensor	Rear
DA3300	DA4149	DA4336	SFP500150	SFP000210		Discovery 2	Front
DA3314	DA4150	DA4339	SFP500130	SFP100470		Discovery 2	Rear
DA3304	DA4481	DA4335	LR019618	SFP500010		Discovery 3	Front
DA3316	DA4484	DA4340	LR019627	LR021316	SFP500140	Discovery 3	Rear
DA3304	DA4481	DA4335	LR019618	SFP500010		Discovery 4	Front
DA4830	DA4837	DA4843	LR021253	LR026221		Discovery 4	Front
DA4831	DA4838	DA4844	LR051626			Discovery 4	Front
DA3316	DA4484	DA4340	LR019627	LR021316	SFP500140	Discovery 4	Rear
Freelander							
DA3301	DA4478	DA4845	LR021899	SFP500100		Freelander 1 - 1996 - from 1A000001	Front
DA3302	DA4479		SFP100360			Freelander 1 - 1996 - up to YA999999	Front
DA3306	DA4486	DA4846	LR004936			Freelander 2	Front
	DA4839		LR027309			Freelander 2	Front
DA3317	DA4487	DA4851	LR003657	LR023888		Freelander 2	Rear
Range Rover							
DA3309*			SFP500220	STC9187		Range Rover Classic - 1986 - 1991	Front
DA3312*	DA4156	DA4842	SFP500180	STC9190		Range Rover Classic - 1986 - 1996 - with sensor	Front
	DA4155		SFP500200			Range Rover Classic - from 1986	Rear
DA3318	DA4485		SFP000270			Range Rover Classic - up to 1985	Rear
DA3319*	DA4154	DA4850	SFP500200	STC9189		Range Rover Classic - up to 1985	Rear
DA3307	DA4153		SFP500220	STC9187	STC9186	Range Rover Classic - up to 1986	Front
DA3300	DA4149	DA4336	SFP500120	SFP100460		Range Rover P38 - 1995 - 2002	Front
DA3314	DA4150	DA4339	SFP500130	SFP100470		Range Rover P38 - 1995 - 2002	Rear
	DA4839	DA4846	LR027309			Range Rover Evoque - 2012 onwards	Front
DA4836	DA4841	DA4854	LR043714			Range Rover Evoque - 2012 onwards	Rear
DA3304	DA4481	DA4335	LR019618	SFP500010		Range Rover Sport - 2005 - 2009	Front
DA3305	DA4482	DA4337	SFP500070			Range Rover Sport - 2005 - 2009	Front
DA3316	DA4484	DA4340	LR019627	LR021316	SFP500140	Range Rover Sport - 2005 - 2013	Rear
DA4830	DA4837	DA4843	LR021253	LR026221		Range Rover Sport - 2010 - 2013	Front
DA4831	DA4838	DA4844	LR051626			Range Rover Sport - 2010 - 2013	Front
DA4833		DA4847	LR064181	LR020362		Range Rover Sport - 2010 - 2013	Front
DA4835		DA4853	LR025739			Range Rover Sport - 2010 - 2013	Rear
DA4831	DA4838	DA4844	LR051626			Range Rover Sport - 2014 onwards	Front
DA4833		DA4847	LR064181	LR020362		Range Rover Sport - 2014 onwards	Front
DA4834	DA4840	DA4852	LR036574	LR065492	LR068303	Range Rover Sport - 2014 onwards	Rear
DA3303	DA4480	DA4338	SFC500080	SFC500050		Range Rover L322	Front
DA3304	DA4481	DA4335	LR019618	SFP500010		Range Rover L322	Front
DA3315	DA4483	DA4341	SFP500210	SFP000120		Range Rover L322	Rear
DA3316	DA4484	DA4340	LR019627	LR021316	SFP500140	Range Rover L322	Rear
DA3305	DA4482	DA4337	SFP500070			Range Rover L322 - 2002 - 2009	Front
DA4830	DA4837	DA4843	LR021253	LR026221		Range Rover L322 - 2010 - 2012	Front
DA4833		DA4847	LR064181	LR020362		Range Rover L322 - 2010 - 2012	Front
DA4835		DA4853	LR025739			Range Rover L322 - 2010 - 2012	Rear
DA4831	DA4838	DA4844	LR051626			Range Rover L405	Front
DA4833		DA4847	LR064181	LR020362		Range Rover L405	Front
DA4834	DA4840	DA4852	LR036574	LR065492	LR068303	Range Rover L405	Rear

IMPORTANT BRAKE INFORMATION

For exact change over points with vehicle applications please contact your local Britpart distributor with the full chassis number for the correct application. These references are intended as a guide only.

*Pad sets exclude shims



Photo courtesy of Kristian Kristjansson

DTEC Brake Pads

Discovery 3		Range Rover L322			
SFP500010DT	Front	SFP500010DT	2002 - 2009	Front	
LR019618DT	Front	SFP500070DT	2002 - 2009	Front	
LR019627DT	Rear	LR019618DT	2002 - 2009	Front	
LR055454DT	Rear	LR019627DT	2002 - 2009	Rear	
Discovery 4		LR055454DT	2002 - 2009	Rear	
SFP500010DT	Front	LR026221DT	2010 - 2012	Front	
LR019618DT	Front	LR015519DT	2010 - 2012	Rear	
LR021253DT	Front	LR032903DT	2010 - 2012	Rear	
LR051626DT	Front	Range Rover Sport			
LR021316DT	Rear	SFP500010DT	2005 - 2009	Front	
LR019627DT	Rear	SFP500070DT	2002 - 2009	Front	
LR055454DT	Rear	LR019618DT	2005 - 2009	Front	
LR015519DT	Rear	LR019627DT	2005 - 2009	Rear	
LR055455DT	Rear	LR055454DT	2005 - 2009	Rear	
Freelander 2		LR021253DT	2010 - 2013	Front	
LR004936DT	Front	LR051626DT	2010 - 2013 & 2014 -	Front	
LR043285DT	Rear	LR019627DT	2010 - 2013	Rear	
		LR055454DT	2010 - 2013	Rear	
		LR015519DT	2010 - 2013	Rear	
		LR055455DT	2010 - 2013	Rear	
		Range Rover Evoque			
		LR027309DT		Front	
		LR043714DT		Rear	



High Performance, Low Dust

DTEC is an advanced, low dust, ceramic formulation which has been developed by TRW for those customers who want cleaner wheels without compromising the braking performance that they are used to. The new material meets all EU legislative requirements as well as TRW's demanding performance requirements. In addition, rim surface dust levels have been reduced by up to 45% when compared to other standard materials. Cotec coating improves green behaviour during bedding in and ensures great pedal feel from the first stop.

Dust levels reduced by up to 45%



Photo courtesy of Henry van Vliet

Brake Hose Kits

Britpart Brake Hose Kits	Standard	Plus 40mm	Plus 150mm
Series 2/Series 3			
SWB - 1960 - 1979 - imperial	DA2418S	DA241840S	
SWB - 1980 - 1984 - metric	DA2419S	DA241940S	
LWB - 1971 - 1979 approx - imperial	DA2420S*	DA242040S	
LWB - 1980 - 1984 - metric	DA2421S	DA242140S	
Defender			
90 - 1984 - 1998 (WA159806)	DA2400S	DA240040S	DA2400150S
110 - 1983 - 1998 (WA159806)	DA2402S	DA240240S	DA2402150S
90/110 - metric - 1999 (XA159807) - 2004 (4A683087) Non-ABS	DA2401S	DA240140S	DA2401150S
From 4A683088	DA3401S	DA340140S	
Discovery 1			
1989 - 1992 (JA034313)	DA2410S	DA241040S	DA2410150S
1992 (KA034314) - 1995 (LA081991)	DA2411S	DA241140S	DA2411150S
1995 (from MA018992) - 1999 - Non-ABS	DA2412S	DA241240S	DA2412150S
1995 (from MA018992) - 1999 - ABS	DA2413S	DA241340S	DA2413150S
Discovery 2			
ABS	DA2414S	DA241440S	
Range Rover Classic			
Up to 1981 - imperial - Non-ABS		DA240340S	
1981 - 1990 - metric - Non-ABS		DA240440S	
1990 - 1992 - metric - ABS		DA240640S	
1992 - metric - ABS		DA240740S	
Range Rover P38			
1995 - up to TA	DA2409S	DA240940S	
Goodridge Brake Hose Kits			
Discovery 1			
1995 (from MA018992) - 1999 - ABS	DA2413		
Range Rover Classic			
107" - imperial - Non-ABS		DA240540	
Series 2/Series 3			
SWB - 1980 - 1984 - metric	DA2419		
LWB - 1980 - 1984 - metric	DA2421	DA242140	

*Note - Front hoses fit directly into the wheel cylinders replacing brake pipe 537763

These brakelines are constructed from the finest quality hose, consisting of a PTFE inner and stainless steel overbraid.

- > Eliminates sponginess under heavy braking.
- > Increases braking efficiency.
- > Abrasion and corrosion resistant.
- > Britpart hoses available at plus 150mm lengths - ideal for use with our Plus 5" suspension products.



Increase your braking efficiency



Handbrake Conversion Kits

Driving off-road you'll know how easy it is for the standard Land Rover hand brake to get bunged up with dirt and once the mechanism gets clogged up it doesn't work as efficiently as it should. Britpart now offer a solution to that problem - a drum to disc conversion kit. These kits use powerful callipers whose mechanism is sealed to prevent the access of mud. Parts are supplied coated with a tough corrosion resistant coating of gold zinc passivate to ensure a long life. Fitting is easy requiring only simple tools. Full fitting instructions are included as well as advice on adjustment and use.

Defender/Discovery/Range Rover Classic

The disc transmission brake uses a state of the art monster sized mechanical calliper designed for agricultural vehicles and earth moving equipment - so using it on a Land Rover is easy work for it. The mechanism is sealed so it will not seize up due to ingress of mud or water and it uses special 'sintered' pads which are resistant to abrasion from mud as well as providing greater friction against the disc than a standard pad. The disc has been specially designed for Land Rovers and manufactured from tough 10mm thick steel. It has a smaller diameter than a standard drum and so does not dangle below the transfer box which helps it to protect it from whatever you are driving over. The calliper mechanism sits in a well protected area at the top, away from most of the mud and water.

DA5513

Defender 90 & 110

For anything post 1993 (300Tdi, Td5 & Puma) you need to change the cable - NRC5088. Puma onwards - modifications may be needed to the chassis to enable fitment.

DA5526

Discovery 1/Discovery 2/Range Rover Classic
Will not fit a Borg Warner or LT95 transfer box.

XDISC

Replacement disc for DA5513 & DA5526

XPAD

Replacement pads for DA5513 & DA5526

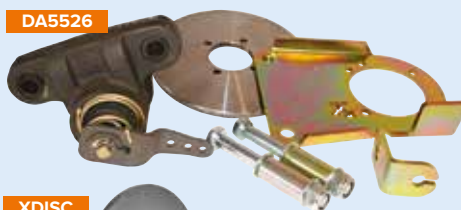

Series

DA5537 Series 1, 2 & 3

This will fit any Land Rover fitted with a standard Series transfer box, including those fitted with PTO's, under or overdrive units. The new brake replaces the original transmission brake drum. It is supplied with a new adjustable actuator rod which connects from your original handbrake lever, direct to the calliper, reducing the amount of slack in the linkages. The disc transmission brake uses an industrial open-frame calliper with simple adjustment and easy cleaning. The new calliper is mounted on a laser cut steel back-plate with a folded gusset for added strength and incorporating a built in skid plate to protect the disc which is manufactured from robust 10mm thick mild steel plate and which bolts directly to your original gearbox output flange with six new bolts (supplied). The system is very light weight, offering a saving of almost 10kg compared to an original drum brake.

DA5537



Beef Up Your Land Rover's Handbrake!



Photo courtesy of LRO Magazine

Engine

EGR Blanking Kits & Tubes



DA1108



DA1109

A Britpart EGR (exhaust gas recirculation) blanking kit enables you to remove the original mechanical EGR from the vehicle resulting in better fuel economy and improved performance.

- DA1108** Defender - 300Tdi engine
Discovery 1 - 300Tdi engine
Range Rover Classic - 300Tdi engine
- DA1109** Defender - Td5 engine
Discovery 2 - Td5 engine
- DA1112** Discovery 3 - TdV6 up to 7A (not EU4) engine
Range Rover Sport - TdV6 up to 7A (not EU4) engine
- DA1087** Freelander 1 - Td4 engine - tube only
- DA1272** Range Rover P38
- DA1088** Range Rover L322 - Td6 engine - tube only



DA1109



DA1112



DA1087 / DA1088



DA1272

EGR Blanking & Silicone Hose Kits



DA1108TDI



DA1109DEF



DA1109DIS



DA1087FL

DA1108TDI
Defender - 300Tdi engine
Discovery 1 - 300Tdi engine
Range Rover Classic - 300Tdi engine

DA1109DEF
Defender - Td5 engine

DA1109DIS
Discovery 2 - Td5 engine

DA1087FL
Freelander 1 - Td4 engine



Photo courtesy of Jundio Salvador

Filter Guards

- > Extends engine life
- > No vehicle modification needed
- > Added protection for stop & go driving and towing
- > Improves fuel economy
- > Cleans engine oil for 50,000 miles
- > Does not effect your Land Rover's warranty

Britpart Filter Guard removes potential engine damaging metal particles from your oil. Clean oil works better than dirty oil with reduced friction and less wear. Britpart's Filter Guard is an inexpensive way of removing the harmful contaminants that conventional oil filters can miss. The contaminants are fine metal particles which act like an abrasive on the fast moving parts in your vehicle's engine - dramatically shortening engine life. Filter Guard works by magnetic filtration technology resulting in cleaner oil which your engine will thank you for by running better now and in years to come. The Filter Guard will never clog or restrict the all important oil flow. **Note** - Filter not included with Filter Guard. Please check that there is sufficient room for the addition of the filter guard.



Added protection for your engine!



Part Number	Filter Guard (diameter x height)	Thread/Insert
DA6080 Fits filters - AEU2218L & ERR3340 Defender/Discovery 1/Discovery 2/Range Rover Classic/Range Rover P38	95mm x 30mm	3/4" x 16
DA6081 Fits filter - RTC3186 Range Rover Classic	95mm x 30mm	9/16" x 16
DA6082 Fits filters - LPW100180L, LPW100230, STC974 & CDU1268 Discovery 1/Freelander 1	77mm x 30mm	9/16" x 16
DA6084 Fits filter - LR007160 Discovery 3/Range Rover Sport - 2005 - 2009/Range Rover L322	77mm x 30mm	1" x 12

Britpart Performance Air Filters

A breath of **fresh air** for your Land Rover

- > A range of performance filters tailored to fit your Land Rover.
- > Maximum breathing efficiency for your engine means more power or better fuel mileage.
- > No compromise on quality - the engine gets more air but the dirt particles are trapped by the quality filters.
- > No need to replace as easy cleaning means maximum performance guaranteed.



- > Easy fit, directly replaces standard air filter.
- > Ideal for use in hot dusty conditions to reduce engine wear.
- > Compatible with snorkels, ideal for use in conjunction with other performance modifications.
- > Filters don't need pre-oiling and if the filter gets dirty there is no need to use a cleaner to clear the dirt on the filter - just use air, water or detergent.

"Breathing efficiency for your engine means more power or better fuel mileage"



DA4274



DA4261



DA4266



DA4259

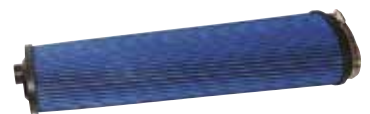

To see an image of each filter go to www.britpart.com/filters

Corresponds to

Series 3	Corresponds to		
DA3138		4-cylinder - fits Zenith and Weber carbs	
DA4274	605191	LWB - 3.5 V8 - 2 filters required	1979 - 1982
Defender	Corresponds to		
DA4269	NRC9238	2.5 petrol	1983 - 1990
DA4269	NRC9238	2.5 D & Td	1983 - 1990
DA4270	NTC6660	2.5 200Tdi	1990 - 1993
DA4262	NTC1435	2.5 300Tdi	1994 - 1997
DA4262	ESR2623	2.5 300Tdi	1994 - 1997
DA4260	ESR4238	Td5	1999 - 2007
DA4379	PHE500060	Puma	2007 -
Discovery 1	Corresponds to		
DA4274	605191	3.5 V8 carb - 2 filters required	1989 - 1990
DA4262	NTC1435	2.5 200Tdi	1989 - 1992
DA4262	ESR2623	2.5 200Tdi	1989 - 1992
DA4268	RTC4683	3.5i V8 Efi	1990 - 1993
DA4264	ESR1049	2.5 200Tdi	1992 - 1994
DA4261	ESR1445	2.0i Mpi petrol	
DA4261	ESR1445	2.5 300Tdi	1994 - 1997
DA4261	ESR1445	3.9i V8	1994 - 1997
Discovery 2	Corresponds to		
DA4260	ESR4238	Td5	1999 - 2004
DA4260	ESR4238	4.0i	1999 - 2004
Discovery 3	Corresponds to		
DA3139	PHE000112	2.7 V6 diesel, 4.0 V6 petrol & 4.4 V8 petrol	
Discovery 4	Corresponds to		
DA3139	PHE000112	2.7 V6 diesel, 3.0 V6 diesel & 4.0 V6 petrol	
DA4376	LR011593	5.0 V8 - nat. asp.	
Discovery Sport	Corresponds to		
DA4637	LR029078	2.0 petrol & 2.2 diesel	
Freelander 1	Corresponds to		
DA4267	ESR4103	1.8 16v	1997 - 2000
DA4267	ESR4103	2.0i Tcic diesel (Rover engine)	1997 - 2000
DA4263	PHE100500L	2.0 Td4 (BMW engine)	2001 - 2006
DA4260	ESR4238	V6 petrol	
Freelander 2	Corresponds to		
DA4375	LR005816	Petrol & diesel	
DA4637	LR029078	from CH000001 - 2.0 petrol	

Corresponds to

Range Rover Classic	Corresponds to		
DA4274	605191	3.5 V8 carb - 2 filters required	1972 - 1986
DA4272		3.5 carb V8 - cone type off-road extreme power filter	
		2 filters required	
		3.5 carb V8 - cone type - replaces 605191	
		2 filters required	
DA4266	RTC4683	3.5i V8 Efi	1985 - 1989
DA4262	NTC1435	2.4D VM Turbo	1986 - 1992
DA4262	ESR2623	2.4D VM Turbo	1986 - 1992
DA4262	NTC1435	2.5D VM Turbo	1986 - 1992
DA4262	ESR2623	2.5D VM Turbo	1986 - 1992
DA4268	RTC4683	3.9i	1989 - 1994
DA4265	ESR341	4.0i V8	1990 - 1995
DA4265	ESR341	4.2i V8	1990 - 1995
DA4265	ESR341	4.6i V8	1990 - 1995
DA4264	ESR1049	2.5 200Tdi	1991 - 1993
DA4261	ESR1445	2.5 300Tdi	1993 - 1995
DA4261	ESR1445	3.9i V8 Efi	1992 - 1994
Range Rover P38	Corresponds to		
DA4265	ESR341	Diesel up to TA346793	
DA4265	ESR341	Petrol up to TA346793	
DA4260	ESR4238	Diesel from TA346794 up to VA376579	
DA4260	ESR4238	Petrol from VA346794 up to VA376579	
DA4260	ESR4238	Diesel from WA376580	
DA4260	ESR4238	Petrol from WA385949 up to WA410481	
DA4265	ESR341	Petrol from WA376580 up to WA385948	
DA4260	ESR4238	Petrol from XA410482	
Range Rover Sport	Corresponds to		
DA3139	PHE000112	2.7 V6 diesel, 4.0 V6 petrol & 4.4 V8 petrol	2005 - 2013
DA4376	LR011593	5.0 V8 nat. asp. & supercharged	2010 - 2013 2014 -
Range Rover L322	Corresponds to		
DA4378	PHE000050	4.4 V8 (BMW engine)	2002 - 2005
DA4377	PHE500021	4.4 V8 nat. asp.	2006 - 2009
DA4377	PHE500021	4.2 V8 supercharged	2006 - 2009
DA4377	PHE500021	3.6 Td8	2007 - 2009
DA4259	PHE000040	Td6	2002 - 2009
DA4376	LR011593	4.4 Td8	2010 - 2012
DA4376	LR011593	5.0 V8 nat. asp. & supercharged	2010 - 2012
Range Rover Evoque	Corresponds to		
DA4637	LR029078	2.0 petrol & 2.2 diesel	



Photo courtesy of Kevin Masson

K&N Air Filters



- DA3137**
RECHAF
- DA3136**
K&N POWER
- DA4275**
AIR FILTER OIL
- DA4273**
Range Rover Classic - 3.9i Efi 1989 - 1992
Cone type, includes hose & fixing kit
- DA4376KN**
LR011593
Discovery 4 - 5.0 V8 - nat. asp.
Range Rover Sport - 5.0 V8 nat. asp. & supercharged - 2010 - 2013 & 2014 -
Range Rover L322 - 4.4 Td8 - 2010 - 2012
5.0 V8 nat. asp. & supercharged
- DA4275**
K&N Dirt retention lubricating oil - 200ml aerosol
- DA3136**
K&N Cleaning solution - 1 litre bottle
- DA3137**
K&N Cleaning kit - 200ml cleaning fluid & 200ml lubricating oil

- > Designed to increase horsepower and acceleration.
- > Washable and reusable.
- > Easy high performance add-on.



Intercoolers - Performance



DA4635
Discovery 3 - 2.7 TdV6
Range Rover Sport - 2.7 TdV6
The original Land Rover intercooler design can have problems due to the blocking up of the core with mud when the vehicles are used off road, as the intercooler is mounted at the lowest point in the front of the vehicle. This intercooler is designed to be easier to clean and less prone to blockage due to the courser, less dense fin design whilst dramatically improving flow, performance and economy, even without any further tuning. Tests have shown a minimum improvement in fuel economy of 12-15%. Power and throttle response in the lower and mid-range engine revs particularly are noticeably improved. The intercooler is designed to be simple to install without major modifications to the vehicle. The performance intercooler makes full use of the space available behind the bumper. It is designed with an integral fan cowl extension to ensure no loss of cooling efficiency and is supplied with mounting brackets and fitting guide.

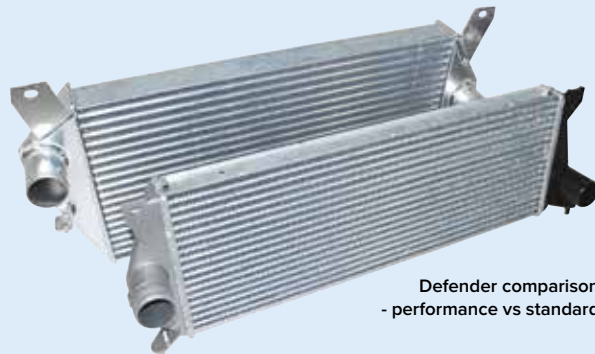

Defender comparison - performance vs standard

These high performance and robust units are constructed from polished aluminium and are 30% larger than the standard intercooler. As a result air has a chance to cool before entering the engine. This cooler air can increase engine power by up to 25bhp (subject to application). Other benefits include better throttle response and reduction in fuel consumption depending on driving conditions. Ideal for on or off road use. Fully pressure tested, capped and sealed.

Increase Engine Power & Reduce Fuel Consumption

DA4630	Defender 90/110 - Td5 - 1998 - 2006 inc. air-con vehicles	60mm deep x 300mm high
DA4634	Defender 90/110 - 2007 onwards inc. air-con vehicles	60mm deep x 300mm high
DA4631	Discovery 2 - Td5 Automatic/manual with transmission oil cooler - 1999 - 2004	60mm deep x 235mm high
DA4632	Discovery 2 - Td5 Manual without transmission oil cooler - 1999 - 2004	60mm deep x 300mm high
DA4633	Range Rover P38 - DSE	60mm deep x 280mm high

Note - Dimensions for main intercooler body only. If you have a winch fitted please check clearance before fitting.



This intercooler is designed to be easier to clean and less prone to blockage.



Better throttle response & reduction in fuel consumption.

Silicone Hose Kits



Britpart Silicone Turbo Hose Kits

DA3170B	Defender - 200Tdi	4 piece kit	Intercooler hose kit
DA3171B	Defender - 300Tdi	3 piece kit	Intercooler hose kit
DA3173B	Defender - Td5	3 piece kit	Intercooler hose kit
DA3174B	Defender - 2.4Tdc	2 piece kit	Intercooler hose kit
DA4578	Defender - 2.2Tdc	2 piece kit	Intercooler hose kit
DA3175B	Discovery 1 - 200Tdi	3 piece kit	Intercooler hose kit
DA3176B	Discovery 1 - 300Tdi	3 piece kit	Intercooler hose kit
DA3177B	Discovery 2 - Td5	4 piece kit	Intercooler hose kit
DA3183	Discovery 3/Discovery 4	1 piece	Intercooler to duct hose (PNH500025)
DA4577	Discovery 3/Discovery 4	3 piece kit	Intercooler to turbo hose (PNH101811)
DA3184	Freelander 1 - Td4	1 piece	Intercooler hose kit
DA3182B	Freelander 1 - Td4	2 piece kit	Intercooler hose kit
DA4582	Freelander 1 - Td4	3 piece kit	Intercooler hose kit
DA3183	Range Rover Sport - 2.7 TdV6	1 piece	Intercooler to duct hose (PNH500025)
DA4577	Range Rover Sport - 2.7 TdV6	3 piece kit	Intercooler hose kit
DA4579	Range Rover Sport - 2005 - 2013 - TdV8	6 piece kit	Intercooler hose kit
DA4580	Range Rover L322 - TdV8	6 piece kit	Intercooler hose kit

Britpart Silicone Coolant Hose Kits

DA4571	Defender - 200Tdi	6 piece kit	Coolant hose kit
DA4570	Defender - 300Tdi	3 piece kit	Coolant hose kit
DA4572	Defender - Td5	1 piece	Coolant top hose kit
DA4573	Defender - Td5	2 piece kit	Coolant hose kit
DA4575	Defender - 2.4Tdc - 2007 - 2012	5 piece kit	Coolant top hose kit
DA4568	Discovery 1 - 200Tdi	3 piece kit	Coolant hose kit
DA4567	Discovery 1 - 300Tdi	3 piece kit	Coolant hose kit
DA4569	Discovery 2 - Td5	1 piece kit	Coolant top hose kit
DA4574	200Tdi & 300Tdi engines	3 piece kit	Expansion tank bleed kit



- > Quality silicone hoses are designed to operate at a higher temperature than the original hoses.
- > Will not rot or perish like rubber hoses.
- > Fit with both standard and performance intercoolers.

Will not rot or perish!

Aluminium Header Tanks



This is a direct replacement for the original plastic tank which is prone to splitting. TIG welded by hand and manufactured from high specification lightweight non-corrosive alloy, this tank also aids cooling. Tank uses original pressure release screw cap and is a straight fit with no modifications required. Ideal for motorsport, overland or just to improve the look of your vehicle's engine bay.

DA4750

Defender - 200Tdi/300Tdi/V8
Discovery 1 - 200Tdi/300Tdi/V8
Range Rover Classic - petrol & diesel - 1990 onwards

DA4751

Defender - Td5 & Td4 Tdci

Electronic Fan Kits

Revotec Electronic Fan Conversion Kits

- > Custom engineered to fit and cool your Land Rover perfectly.
- > Supplied complete with all necessary fittings and fixings to complete an electronic fan conversion on your vehicle. Kits include mounting brackets or shroud, 35mm Revotec electronic fan controller designed for Land Rovers with an extended loom, earth wire kit and bolts & fixings.
- > Engineered to fit without any permanent modifications and utilising original radiator mountings.
- > Easy to install with basic hand tools.
- > Latest fan and controller technology used together for the ultimate cooling package.

DA8963	Series 3
	14" High power blowing fan
DA8964	Series 3 V8
	2 x 12" High power suction fans
DA8965	Ninety/One Ten - 2.5 petrol/2.5 diesel/2.5 TD
	15.2" High power suction fan
DA8966	Ninety/One Ten - V8
	2 x 12" High power suction fans
DA8967	Defender & Discovery - 200Tdi/300Tdi
	15.2" High power suction fan
DA8968	Defender & Discovery - Td5
	15.2" High power suction fan
DA8969	Defender - Tdci
	15.2" High power suction fan
DA8970P	Range Rover P38 - petrol
	15.2" High power suction fan



Custom engineered to fit and cool your Land Rover perfectly



Air Conditioning Fans

DA8971 Defender
This is a direct replacement to the vehicles original air conditioning fan.
Kit contains - 1 x 10" blowing fan.

DA8972 Discovery 2
This is a direct replacement for OEM Part No. JRP100000.
Kit contains - 1 x 12" high power blowing fan, 2 x anodised brackets & 1 x fixing kit.

Powerlite Starter Motors & Dynalite Alternator

Powerlite Starter Motors

High torque gear reduction starter motors. These lightweight units offer increased cranking speeds and considerably more cranking power than original units, whilst drawing less current from the battery.

NAD10040HD NEW
Defender - 2½ petrol 4-cylinder

NAD101490HD NEW
Defender - V8/Discovery 1 - V8
Discovery 2 - V8
Range Rover P38 - V8 - 1994-2001

RTC5225HD NEW
Series 3 - 2¼ petrol
RTC5232HD NEW
Series 3 - 2¼ diesel
RTC3840A NEW
Series 2 & 2A - 2¼ litre 4-cylinder



More information and images online

Dynalite Alternator

Designed & manufactured by highly experienced auto electricians in the UK. The Dynalite aims to bring together modern alternator technology with the classic looks and appearance of a Dynamo. Ideal for both road and competition use the Dynalite provides up to 80% more power and weigh up to 40% less than original dynamo units. The Dynalite unit directly replace dynamo units with no modifications to the vehicle. The self regulating Dynalite unit offers increased reliability and performance charging efficiently across the full rev range. The wiring changes required for the units are very simple and reversible. All Dynalite units are supplied with comprehensive fitting instructions.

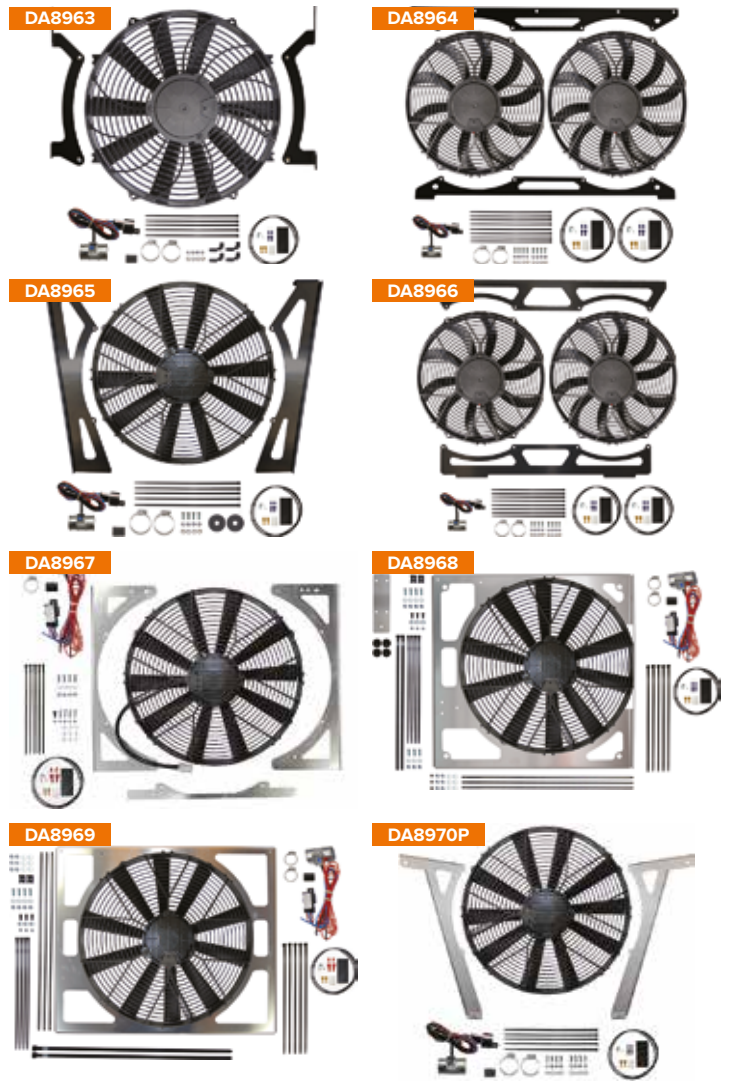

Electronic Fan Controller

DA8973
> 35mm
> To fit extended loom
> Negative earth housing. Fits directly in to a radiator top or bottom hose for direct water contact.
> Supply Voltage: 12v
> Space in hose approx: 35mm
> Overall length approx: 65mm
> Material: Aluminium
> Relay Rating: 30 AMPS
> Wire Length: 2,500mm
Kit contains -
2 x hose clamps, relay, cap, 3 x cable ties, fitting Instructions.



Fan Override Switch

DA8974
3-way rotary switch for use with a Revotec fan controller enabling the fan to be manually controlled either on, off or automatic. Perfect for 4 x 4 applications such as wading. This product must be used with a Revotec electronic fan controller. Kit contains -
Black anodised mounting bracket kit.
Position decal.
Sealed 3m wiring loom and connection diagram.



PSI Power Tuning Products

DA4419



Improves torque

Improves m.p.g

The Power Box houses a digital microprocessor which intercepts the fuelling signals being transmitted from the ECU to the fuel pump; it then modifies them to ensure the exact amount of diesel required for enhanced performance. Such efficient use of the fuel optimises consumption, reduces smoke emissions and there is less engine stress, enhancing engine life in many cases.

The Power Box improves torque enabling the vehicle to change gears earlier and hold higher gears at lower speeds, making driving more pleasurable. The unit fits using the original manufacturers plugs; these existing plugs are opened and the Power Box is secured in between. Full fitting instructions are included with every unit.

Features

- > Plug-in unit
- > No intervention with the original ECU
- > TÜV approval
- > Compact size
- > Shock resistant & waterproof
- > Competitively priced

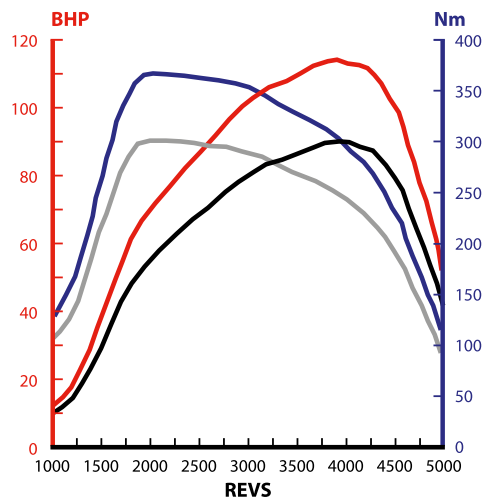

DA4418	Freelander 1 - Td4 - 2000 - 2006	110 / 135	82 / 101	260 / 309
DA4419	Range Rover P38 - 2.5Td - 1995 - 1999	134 / 162	100 / 121	268 / 319
DA4420	Range Rover P38 - 2.5Td - 2000 - 2001	134 / 162	100 / 121	268 / 319
DA4421	Range Rover L322 - Td6 - 2002 onwards	175 / 204	130 / 152	390 / 449
DA4433	Defender/Discovery 2 - Td5 - 1999 - 2007	121 / 153	90 / 114	360 / 424
DA4436	Defender - 2.4TdcI - 2007-2011	121 / 153	90 / 114	360 / 424
DA4434	Discovery 3/Range Rover Sport - 2.7 TdV6 - EU3	188 / 220	140 / 164	440 / 519
DA4435	Discovery 4/Range Rover Sport - 3.0 TdV6	252 / 286	188 / 213	600 / 677

Power - HP	Power - Kw	Torque - Nm
110 / 135	82 / 101	260 / 309
134 / 162	100 / 121	268 / 319
134 / 162	100 / 121	268 / 319
175 / 204	130 / 152	390 / 449
121 / 153	90 / 114	300 / 374
121 / 153	90 / 114	360 / 424
188 / 220	140 / 164	440 / 519
252 / 286	188 / 213	600 / 677

Performance for Defender - Td5
Standard 121Hp 90Kw 300Nm
With PSI **158Hp 118Kw 374Nm**

Benefits

- > Can be removed prior to sale or used as a selling point
- > Traceless
- > Peace of mind
- > Quality product which is legal & safe
- > Unobtrusive in interior of vehicle
- > No worries off road
- > A good investment



Sign up to the regular Britpart newsletter to find out about all the latest product releases.
www.britpart.com/newsletter

Tuning Box



DA4507

Tuning box for the Defender - Puma 2.2TdcI

Power increases by **27bhp** (20kw)
Torque increases by **71Nm**

The 2011 onwards 2.2 Tdci model Defender has new style piezo injectors and requires specialised tuning solutions. It is currently not possible to remap the ECU through the OBD port. This substantial new tuning unit is designed to plug directly into the wiring loom and requires no modification to the vehicle. Contained in waterproof housing so can be safely located in the engine bay.



Photo courtesy of Natalie Moore

Tunit

DA4437

Freelander 2 - 2.2 Td4 - 2007 onwards

Power improvement - before / after
Power - HP 152 / **177** Power - Kw 112 / **130** Torque - Nm 295 / **325**



Tunit Diesel Performance - The Diesel Tunit has been forged from many years of experience to bring a world class unbeatable range of diesel performance solutions.

Tunit Features - Tunit possesses many advantageous features not seen in other tuning solutions such as chips, eeprom serial reprogramming (flashing) or other types of fixed map devices. It is interchangeable between vehicles and able to be upgraded. External to the ECU or 'Plug and play' as it is often called means no interference with the original manufacturers engine equipment. Its option to adjust power and performance provides easy manual adjustment for the novice or finer electronic alterations for the more dedicated tuner.

Fuel Savings - Tunit has become advantageous in reducing fuel costs for a variety of applications; not just improving performance but now helping with saving fuel costs.

Installation - The Tunit is normally connected to original plugs on the vehicle and can either be self-installed or by a professional mechanic.

Upgrade Chips

DA4497

Range Rover P38
Replacement ECU chip to improve power and economy on the GEMS engine 4.0 and 4.6 in the Range Rover P38. Fitting this chip will increase economy by approx 15% and power by 10%. Once fitted, it helps makes a big difference to the driveability of the vehicle by improving throttle response and mid-range pull.

No trade off between fuel economy and increased power!



Accelerate technology

Limitations and restrictions exist which prevent your vehicle from achieving optimal performance. The manufacturer's emissions test is extremely rigorous due to inclusion of all parts of the driving cycle, especially warm up and full load operation, which is where problem emissions are at a maximum. To meet these they compromise performance and efficiency of the engine - this chip helps redress that balance.

Off roaders in the driving seat

Your requirements are met through a stable and predictable idle quality, good engine braking and an engine which has plenty of midrange torque. Perfect idle control for hill descents and winching, with no possibility of stalling. Total reliability ensures you never lose control.

Greater expectations

By comparison we know climate conditions and fuel quality your vehicle experiences and can therefore improve efficiency by reducing fuel consumption and optimising the engine to get its best performance on full load, which is less than 10% of the time.

Turbo Boost Box

DA4667

The Td5 engine fitted in Defenders and Discoverys is one of the most 'tuneable' engines available and it responds well to modifications including a PSI power tune box, larger intercooler, EGR removal kit and decat pipes. However the turbo will only boost to 14.7psi in standard form and this will quickly limit the potential from the modifications you have made. The ECU will cut fuel to the engine if it detects an over boosting situation, but there is a solution.

Turbo Boost Box! This intelligent box allows the Td5 engine to run with a higher boost pressure after adjusting the waste gate in accordance with the instructions. This allows increased turbo boost pressure without the engine going into limp home mode. You will feel the benefits of fitting the Turbo Boost Box as soon as you drive. At the lower rpm's the vehicle will feel more responsive whilst at the same time giving you a much smoother spread of power through the rpm range. An added benefit is a reduction of exhaust smoke.

You will feel the benefits of fitting the Turbo Boost Box as soon as you drive!

Fitting the Turbo Boost Box is an easy 3 wire installation. The box is manufactured from extruded aluminium and easy to fit as it uses the original Land Rover connectors. The box is 99% water resistant - ideal for most off-road uses.

This product must be fitted by a competent mechanic in accordance with the included instructions, incorrect waste gate adjustment can lead to engine damage.



Weber Carburettors

DA3049



Part of the conversion kit

ERC2886W



DA4538



Note - Due to the synchronising of the throttle chokes in order to enhance performance the cold start (choke) capability has been removed from this carburettor.

DA3049

V8 4-Barrel conversion kit including manifold
The Webcon 4 barrel replacement carburettor kit is a direct replacement for the twin Stromberg or SU carbs fitted to the Rover V8. Calibrated to work perfectly on the 3.5 and 3.9 engines, the Webcon kit is the most complete on the market and features a Webcon modified Weber 4 barrel 500cfm carburettor, intake manifold, air filter and every single nut, bolt washer, gasket and hose that could possibly be needed. The kit adds up to 20bhp at the wheels and transforms the driveability and economy. Starting becomes instant either hot or cold and with no balance adjustment to worry about with twin carbs, the engine is simply superbly smooth as a V8 should be.

ERC2886W

Series - replacements for the Zenith 361V
Available for LHD, RHD, with or without fuel shut off solenoid, the Weber range of carburettor kits to replace the Zenith 361V offer the optimum balance of power and economy together with the legendary quality and reliability of Weber. Shipped as complete turnkey solutions, all kits are supplied with every nut, bolt, washer and gasket required and comprehensive, easy to follow instructions ensure that installation can be carried out with no specialist carburettor knowledge.

DA4538

Twin choke performance carburettor kit for Land Rover 2.25ltr engines.
The kit is fitted with Webcon's new Sync Link kit allowing synchronous opening of the Weber 32/36 DGV throttle butterflies. This greatly enhances low speed driveability and torque, essential for off-road driving. This kit will fit all engines fitted with a tubular exhaust manifold. If the original exhaust manifold is still fitted, a simple 4-hole blanking plate will need to be fabricated to block the aperture left when the OE intake manifold is removed.

DA3049AF Replacement air filter for DA3049

DA3049KD Weber kick down kit for use with DA3049 on automatic vehicles.

DA2126 Series carburettor - to replace Solex use also STC541 adaptor

DA2126A Choke cable for DA2126

DA2206 Service kit for DA2126 & ERC2886W

DA3049AF



DA3049KD



DA2126



DA2126A



DA2206



Exhaust Systems

Stainless Steel Exhaust

DA3340



DA3340

Discovery 4
3 litre diesel with DPf

Front Downpipes

DA3262

Defender
300Tdi - downpipe less cat
Equivalent to ESR2297

DA4348

Defender 90 - Equivalent to WCD000960
Discovery 2 - Equivalent to WCD000500
Td5 - downpipe less cat - mild steel

DA4359

Defender 90 - 2.4 EU4
2007 onwards - downpipe less cat
Equivalent to LR020683

ESR2740

Discovery 1
Range Rover Classic
300Tdi - downpipe less cat
Equivalent to ESR2440

DA4396

Discovery 3
TdV6 - downpipe less cat
Equivalent to WCD500433

Note - Fitting downpipe may then require vehicle needing an engine re-map by a specialist.

DA3262

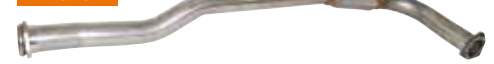

DA4348



DA4359



ESR2740



DA4396



Double 'S' Stainless Steel Exhausts

Stainless Steel - Standard Exhaust Systems

Series

DA4540	Series 1 - 88"	2.25 diesel - 4 stud manifold exit	Front pipe / link pipe / rear silencer
DA4251	Series 3 - SWB	2.25 diesel - 3 stud manifold exit	Front pipe / link pipe / rear silencer
DA4528	Series 3 - SWB	2.25 petrol	Front pipe / link pipe / rear silencer

Defender

DA4231	Defender 90	200Tdi	Front pipe / centre box / rear silencer
DA4232	Defender 90 - 1994 - 1995	300Tdi	Front pipe / centre box / rear silencer
DA4233	Defender 90 - 1995 - 1997	300Tdi	Front pipe / centre box / rear silencer
DA4234	Defender 90 - 1997 - onwards	300Tdi	Centre box / rear silencer
DA4235	Defender 90	Td5	Centre box / rear silencer
DA4244	Defender 110	Td5	Centre box / rear silencer
DA4228	Defender 110	200Tdi	Front pipe / centre box / rear silencer
DA4229	Defender 110	300Tdi	Front pipe / centre box / rear silencer

Discovery

DA4221	Discovery 1	2.5Td & 200Tdi Manual	Front pipe / centre box / rear silencer
DA4222	Discovery 1	200Tdi Automatic	Front pipe / centre box / rear silencer
DA4223	Discovery 1	300Tdi	Centre box / rear silencer
DA4224	Discovery 2	Td5	Centre box / rear silencer
DA4397	Discovery 3	TdV6	Twin tail exhaust

Freelander

DA4226	Freelander 1	1.8 petrol - up to YA999999	Centre box / rear silencer
DA4246	Freelander 1	1.8 petrol - up to YA999999	Transplex rear silencer (2 x 3" roll tailpipe)
DA4227	Freelander 1	2.0 diesel - up to YA999999	Link pipe / rear silencer

Range Rover

DA4237	Range Rover Classic - cat & non-cat	3.9 V8 from catalyst to back	Centre box / rear silencer
DA4238	Range Rover P38	2.5 BMW diesel single tailpipe	Centre box / rear silencer
DA4239	Range Rover P38	4.0/4.6 single tailpipe	Centre box / rear silencer
DA4240	Range Rover P38	4.0/4.6 twin tailpipe	Centre box / silencers - RHS & LHS
DA4241	Range Rover P38	2.5 BMW twin tailpipe	Centre box / silencers - RHS & LHS
DA4395	Range Rover Sport	4.2 V8 Supercharged	Centre box / link pipes - RHS & LHS / rear silencers - RHS & LHS
DA6815	Range Rover Sport	4.4 - 2005 - 2009	Front silencer / link pipes - RHS & LHS / rear - RHS & LHS
DA6816	Range Rover Sport	5.0 - 2009 - 2012	Front silencer / link pipes - RHS & LHS / rear - RHS & LHS
DA6812	Range Rover L322	4.2 - 2005 - 2009	Link pipes - RHS & LHS / twin rear silencer
DA6811	Range Rover L322	4.4 - 2002 - 2005	Link pipes - RHS & LHS / silencer
DA6813	Range Rover L322	4.4 - 2005 - 2009	Link pipes - RHS & LHS / twin rear silencer
DA6814	Range Rover L405	5.0 Supercharged - 2012 onwards	Front silencer / link pipe RHS & LHS / rear silencer RHS & LHS
DA6817	Range Rover Evoque	2.2 - 2011 onwards	Link pipe / Y-section / tail pipe - RHS & LHS

Double 'S' is recognised as one of Europe's leading manufacturers of stainless steel automotive components with a wide selection of systems for off-road use.

Using only the finest austenitic and ferritic stainless steels and employing the latest in CNC mandrel and empty tube bending, measuring and inspection equipment, means increasingly high levels of product quality.



All Double 'S' exhaust systems carry a lifetime guarantee. Double 'S' will replace or repair any part of their Stainless Steel Exhaust Systems found defective through corrosion during the period that the system remains the property of the original owner. Provided that the system is inspected by a garage or exhaust fitting centre annually to ensure that the rubber and other mountings are in good condition.

For many more images - www.britpart.com/double-s

DA4251

DA4232

DA4233

DA4224

DA4246

DA4227

DA4240

DA4241

DA4395

DA6816

DA6812

DA6811

DA6814

DA6817

Exhaust Fitting Kit
Series - SWB
DA1293 RHD
DA1294 LHD

Double 'S' Stainless Steel Exhausts - continued

Stainless Steel - Sports Exhaust Systems

Defender			
DA4236	Defender 90	3.5 V8 sports system	Manifolds - RHS & LHS / Y-Pipe / rear silencer / tailpipe / fitting bracket & kit
DA4249	Defender 90	Td5 sports system	Sports centre link pipe / rear silencer
DA4230	Defender 110	3.5 V8 sports system	Manifolds - RHS & LHS / Y-Pipe / extension pipe / centre box / tailpipe / fitting bracket & kit
Discovery			
DA4225	Discovery 1	3.9 V8 Japanese spec sports system with cat	Centre box / link pipe / rear silencer
Range Rover			
DA4242	Range Rover Classic	3.5 V8 Efi sports system with tubular manifold	Manifolds - RHS & LHS / Y-Pipe / centre box / rear silencer
DA4243	Range Rover Classic	3.9 V8 Efi sports system with tubular manifold	Manifolds - RHS & LHS / Y-Pipe / link pipe / centre box / rear silencer
DA4243EXT	Range Rover Classic	Extension piece for DA4243 for use on long wheel base Range Rover Classic LSE models	
DA4245	Range Rover P38	4.0/4.6 sports system with twin tailpipe	Rear silencers - RHS & LHS / Y-Pipe / centre box
DA4247	Range Rover P38	2.5 diesel sports system with twin tailpipe	Rear silencers - RHS & LHS / Y-Pipe / centre box



Double 'S' Stainless Steel Exhausts - Components

Defender		Discovery 1	
ESR1585SS NEW	Front pipe	ESR3495SS NEW	Front pipe
ESR22975SS NEW	Front pipe - non-cat	NTC1322SS NEW	Intermediate silencer
ESR2381SS NEW	Intermediate pipe & silencer	NTC6791SS NEW	Intermediate silencer
ESR2383SS NEW	Intermediate pipe & silencer	Discovery 2	
ESR3495SS NEW	Front pipe	WDE100590SS NEW	Intermediate silencer
ESR3585SS NEW	Front silencer	Freelander 1	
ESR4526SS NEW	Centre silencer	WCE104231SS NEW	Intermediate pipe
ESR545SS NEW	Intermediate pipe & silencer	WDV500020SS NEW	Rear silencer
NRC4218SS NEW	Intermediate pipe	Range Rover Classic	
NRC4219SS NEW	Front pipe - left	NTC1322SS NEW	Intermediate silencer
NRC6432SS NEW	Front pipe - right	Range Rover P38	
NRC6433SS NEW	Intermediate pipe & silencer	ESR3195SS NEW	Intermediate pipe & silencer
NRC6436SS NEW	Intermediate pipe	ESR33538SS NEW	Rear tailpipe & silencer
NRC7842SS NEW	Rear tailpipe & silencer	WDV100260SS NEW	Twin tailpipe & silencer - left
NRC8888SS NEW	Intermediate silencer	WDV100270SS NEW	Twin tailpipe & silencer - right
NRC8889SS NEW	Rear tailpipe & silencer	Series	
NRC9137SS NEW	Front pipe	244449SS NEW	Intermediate pipe
NRC9836SS NEW	Rear tailpipe & silencer	264195SS NEW	Intermediate pipe
NTC1149SS NEW	Rear tailpipe	500289SS NEW	Intermediate pipe
NTC1150SS NEW	Rear silencer	503456SS NEW	Intermediate pipe
NTC1665SS NEW	Intermediate silencer	517469SS NEW	Front pipe
NTC1666SS NEW	Intermediate pipe & silencer	562731SS NEW	Rear silencer
NTC1800SS NEW	Rear tailpipe & silencer	562858SS NEW	Front pipe
NTC2726SS NEW	Y pipe	598540SS NEW	Rear silencer
NTC2832SS NEW	Rear tailpipe & silencer	599378SS NEW	Silencer & tailpipe
NTC4221SS NEW	Intermediate pipe	624196SS NEW	Front pipe
NTC4426SS NEW	Front pipe		
NTC4614SS NEW	Intermediate silencer		
WCE000030SS NEW	Centre silencer		
WCE000040SS NEW	Centre silencer		



Exhaust Clamps



DA4062	45mm	Qty 1
DA4186	54mm	Qty 1
DA4063	60mm	Qty 1
DA4064	65mm	Qty 1

For many more images
www.britpart.com/double-s



Photo courtesy of Nicola Morson

Utility Link Pipes & Rear Silencers

Britpart Link Pipe	Double 'S' Rear silencer	
DA4371	DA3250	Defender 90 - 2007 onwards
DA4292	DA3250	Defender 90 - Td5
DA4294	DA3251	Defender 90 - 300Tdi 1994 - 1995
DA4294	DA3252	Defender 90 - 300Tdi 1995 - 1997
DA4304	DA3253	Defender 90 - 300Tdi 1997 - 1999
DA4295	DA3254	Defender 90 - 200Tdi
DA4372	DA3255	Defender 110 - 2007 onwards
DA4293	DA3255	Defender 110 - Td5
DA4302	DA3256	Defender 110 - 300Tdi
DA4306	DA3257	Defender 110 - 200Tdi
Discovery		
DA4291	DA3258	Discovery 1 - 300Tdi Note - Will only fit with Double 'S' rear silencer (DA3258)
DA4303	DA3259	Discovery 1 - 200Tdi Discovery 1 - 300Tdi Sport system kit
DA4223S		Note - Kit includes Double 'S' rear silencer (DA3258)
ESR2391S		Discovery 1 - 300Tdi Sport system kit
DA4290	DA3260	Discovery 2 - Td5
Freelander		
DA4537		Freelander 1 - Td5 Rear silencer

These stainless steel exhaust silencer replacement pipes are designed to directly replace the front silencer in your exhaust system. Once replaced the pipe will give your vehicle more power or reduced fuel consumption with only a small increase in cabin noise. CNC mandrel formed for a perfect fit with laser cut flanges, the pipes have a sateen finish, deep lustre appearance. Quick and easy to install.



Reduced fuel consumption

Quick and easy to install with more power

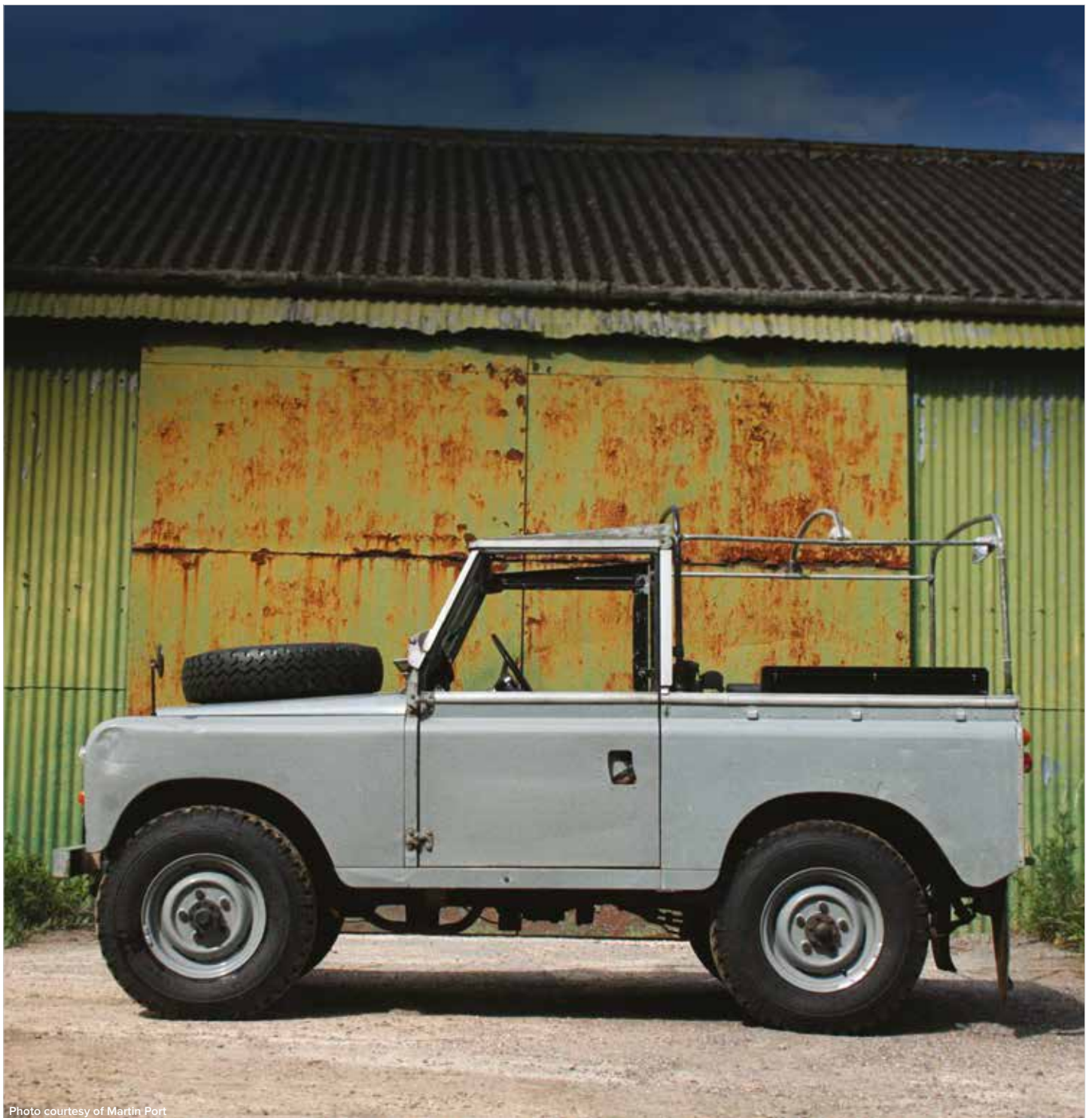

Photo courtesy of Martin Port

Transmission



Roamerdrive Overdrive Units

DA9017



Defender DA9017 Overdrive Unit

Reduced engine speed contributes to quieter more comfortable travel under motorway conditions and reduces wear & tear

The distinctive third lever on the centre console of a Defender identifies it as a vehicle equipped with a Roamerdrive overdrive. This rugged, bolt on accessory has been proven in hundreds of installations and tested under the most demanding expedition conditions. No other modification improves the performance and economy of your Land Rover like a Roamerdrive. The DS model overdrive is an auxiliary gearbox that is easily fitted to a Defender 90 or 110 with standard five speed transmission. The unit adds an optional 28% to the ratio of the drive train giving improved fuel economy. Reduced engine speed contributes to quieter more comfortable travel under motorway conditions and reduces wear and tear on mechanical components.

The Roamerdrive is a completely mechanical device built in the tradition of rugged dependability that has made Land Rover the world's favourite expedition vehicle. These overdrives have no electronic or hydraulic components. They are controlled by moving the convenient hand lever.

Unlike a high ratio transfer case that will permanently detract from the versatility of the gearbox, the Roamerdrive does not alter the vehicle's designed gear ratios. Off road performance is enhanced as the overdrive ratio can be added to any gear in high or low range.

The Roamerdrive uses the same epicyclic gear technology as a modern automatic transmission and runs quietly. This is particularly evident at high speeds and makes driving a Defender for long distances a pleasurable experience. On long journeys Roamerdrive users have reported fuel savings of up to 18% - not surprising when you consider that the engine lopes along the highway at about 2,000rpm - a favourable spot on the diesel torque band. Although precise fuel savings will depend on your driving habits.

DA9017



DA9018 Transfer Case Sump Cover

Fits all Land Rover Defender, Discovery and Range Rover Diesel models fitted with 230 type transfer case. Billet transfer case sump oil coolers are designed to replace the flimsy sump covers supplied as standard equipment. These covers are stronger than the originals and have cooling fins to keep the oil in your transfer case cool in harsh conditions. The sump cover is supplied with a new gasket, and the existing bolts are used for installation. The sump cover is significantly stronger than the original and adds about 1/2 litre to oil capacity. Existing ground clearance is not compromised. A plugged port is supplied so that DA1285 oil temperature gauge can be fitted. It is possible to fit this sump cover to V8 models but check first that there is good clearance between the cover and existing exhaust pipes.

DA9018



DA1285 Oil Temperature Gauge

This oil temperature gauge is a high precision mechanical temperature gauge with a full 270 degree sweep. The unit is designed to compliment DA9018 transfer case sump cover and fits directly to a pre-drilled port in the sump cover. The unit fits into a standard two inch mounting hole and operates completely independently of electrical power. A 12 volt lamp supplies illumination. The gauges are far more accurate than common electrical types using thermistor senders. These gauges can also be used to measure cooling water temperature or engine oil temperature in commercial or marine applications. The sending tube is 240cm (8ft) long, and contains pressurised fluid so it cannot be shortened - but you can coil surplus tube behind your dash.

DA1285



DA9015

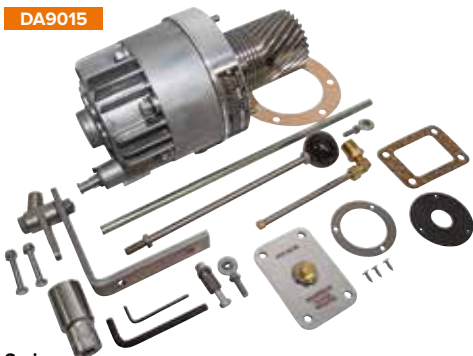

DA9015



DA9016



Series DA9015 Overdrive Unit

The distinctive extra lever on the right hand side of the transmission tunnel on a Series 1, 2 or 3 shows that it is equipped with a Roamerdrive. Since 2002 the majority of new overdrives fitted to these timeless vehicles have been simple rugged units. Proven in hundreds of installations worldwide, this rugged and well engineered product will improve the performance and economy of your collectable Land Rover. The SS model Roamerdrive is an auxiliary gearbox that is easily fitted to a Series 1, 2 or 3 with a 4 or 6 cylinder engine. The unit adds an additional 28% to the ratio of the transmission giving improved fuel economy. Reduced engine speed contributes to quieter more comfortable travel at motorway speeds and extends the life of drive train components.

The Roamerdrive is a completely mechanical device built in the same tradition of rugged dependability that has made Land Rover the world's favourite expedition vehicle. These overdrives have no electronic or hydraulic components. They are engaged or disengaged by moving a convenient lever.

Unlike a high ratio transfer case that will permanently detract from the versatility of the gearbox, the Roamerdrive does not affect the vehicle's designed gear ratios. The unit provides useful 'splitter' gears such as a gear ratio midway between conventional third and fourth.

The Roamerdrive uses the same epicyclic gear technology as a modern automatic transmission and is very quiet running. This is particularly evident at higher speeds and makes driving a Series Land Rover for long distances a more pleasurable experience. Fuel savings will depend on your driving habits. On long journeys Roamerdrive users have reported fuel savings of up to 18%.

DA9016 Transfer Case Sump Cover

Fits all Land Rover Series 1, 2, 2A and 3 models (except V8) Billet transfer case sump oil coolers are designed to replace the flimsy sump covers supplied as standard equipment. These covers are stronger than the originals and have cooling fins to keep the oil in your transfer case cool in harsh conditions. This Series model is supplied with a new gasket and replacement fastening bolt to replace the brittle standard studs. Being solid aluminium, the cover completely eliminates leaks caused by differential expansion. If your vehicle is pre 1980 you can use your existing drain plug and washer. Owners of Later Series Vehicles with Metric fasteners should purchase a plug (Land Rover part 235592) to fit the threads in this casting. As the cover expands at the same rate as the aluminium transfer case the stubborn oil leaks associated with the original steel cover are completely eliminated.



Photo courtesy of LRO Magazine

Suspension & Axle

Upgrade your shock absorbers or springs for improved ride quality and reliability. Britpart have plenty of suspension and axle equipment to meet your specific requirements to ensure a smoother ride!

Air Suspension Compressors	134	Propshafts	
Axle		Propshaft kit.....	143
Anti-roll bar kits.....	128	Propshaft spacer kit.....	143
Bush kits.....	128	Wide angle propshafts.....	143
Castor corrected swivel housings.....	128	Shock Absorbers	
Fulcrum brackets.....	128	Bilstein.....	137
Heavy-duty drive flanges.....	128	Boge.....	137
Meyle heavy-duty.....	129	Britpart Cellular Dynamic.....	136
Panhard rods.....	128	Britpart Super Gaz.....	136
Radius arms.....	129	Britpart XD Remote Reservoir.....	135
Suspension arm & bolt kits.....	129	Heavy-duty.....	135
Suspension bolt kits.....	130	Old Man Emu.....	137
Brackets, Mounts & Ancillary Products		Springs	
Adjustable ball joint.....	131	Air lift kits.....	138
Dislocation cones.....	131	Air spring conversion kits.....	141
Lift rod kit.....	131	Leaf spring castor correction wedges.....	139
Rear spring sets.....	131	Springs - air.....	138
Shock absorber brackets & turrets.....	130	Springs - coil - lifted.....	140
Spring retainers.....	131	Springs - coil - lowered.....	139
Spring spacer blocks.....	131	Springs - coil - standard.....	140
Turret rings.....	131	Springs - leaf.....	138
Bushes		Springs - Old Man Emu.....	139
Bump stops.....	132	Springs - parabolic.....	138
Bush fitting tool.....	132	Steering	
Bush sets - Britpart.....	134	Steering arms - heavy-duty.....	143
Bush sets - Britpart polyurethane.....	133	Steering dampers.....	143
Bush sets - Castor correction.....	132	Suspension Kits	142
Bush sets - Meyle heavy-duty.....	132		
Bush sets - Polybush.....	132		
Bush sets - Powerflex.....	134		
Bush set - Watts linkage.....	132		



> Suspension & Axle

Axle

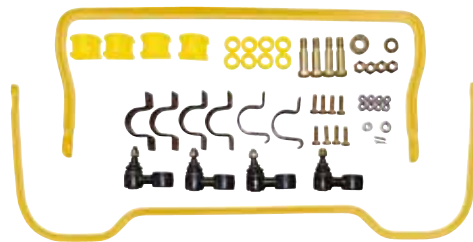

STC8156AAPY

Defender 90, 110 & 130/Discovery 1/Range Rover Classic Yellow anti-roll bar kit with Britpart yellow polyurethane bushes.

Stiffen up your Land Rover! Front and rear kits complete with fitting instructions. Only suitable for vehicles with the chassis and axle brackets fitted.

Note - To fit these anti-roll bars to the rear of a Defender 90 Td5 - onwards 2 x EGP1661L & 2 x EGP1889 are required. To fit to a Defender 110/130 Td5 - onwards 2 x NRC5674 & 2 x 592773 are required.

Fulcrum Brackets

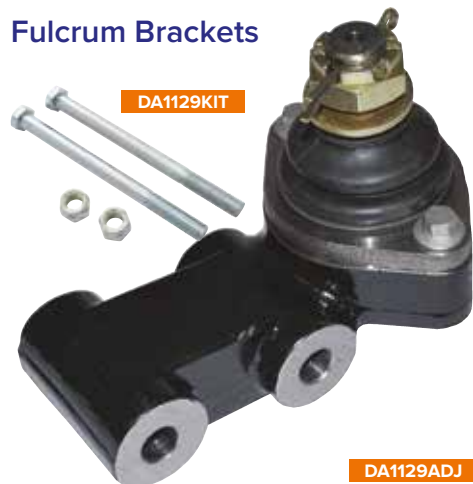

Fulcrum brackets Defender/Discovery 1/Range Rover Classic

DA1129 With ball joint assembly (ANR1799)

DA1129G With OEM ball joint assembly (ANR1799G)

DA1129ADJ With adjustable ball joint assembly (ANR1799A)

DA1129KIT Fitting kit for all fulcrum brackets

Anti-Roll Bar Kits

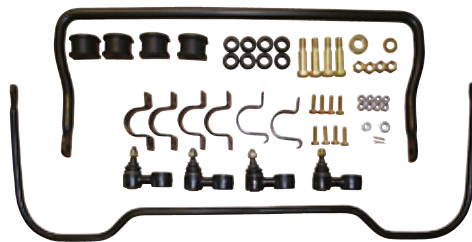

STC8156AA

Defender 90, 110 & 130/Discovery 1/Range Rover Classic Black anti-roll bar kit with rubber bushes.

Heavy-Duty Drive Flanges



These heavy-duty drive flange kits have been engineered to outperform many of the inferior products available on the market. Manufactured from 5140 steel, they are much stronger than an OE drive flange. Complete with hex head bolts and screw on caps with integral seal.

DA1148 Defender - from LA/Discovery 1 - from JA Range Rover Classic - ABS and front from JA Pair

DA1149 Defender - up to KA Pair

DA1148CAP Replacement drive flange cap with rubber seal for DA1148 & DA1149 Single

DA1128 Replacement drive flange bolt set for DA1148 & DA1149 Qty 10



DA1129ULTRA

Fulcrum bracket with high articulation for Defender Discovery 1 Range Rover Classic



DA1129ULTRA

One of the major factors limiting the rear suspension movement on vehicles fitted with an A-frame is the standard ball joint. We have developed this part to provide significantly more articulation than the standard and most aftermarket joints. Others claim more articulation yet in reality they offer very little over the standard 30°. This exclusive ball joint offers 45° movement in all directions. It is easily adjustable with a regular hex spanner and has a grease nipple for convenient regular maintenance. It is supplied fitted ready to bolt to your Land Rover.

Castor Corrected Swivel Housings

DA3203

'3 degrees of additional castor'



DA3203

Defender - from LA up to WA

DA2992

Discovery 1 - JA32851 onwards - non-ABS

Range Rover Classic - JA624517 onwards - non-ABS

Normally the only way to correct the castor angle on a beam axle vehicle is to fit castor corrected radius arms or go through the lengthy process of repositioning the brackets on the axle. Something which takes considerable time and skill. Britpart offer you an alternative. These castor corrected swivel housings come as a handed pair. They are a direct replacement for vehicles normally using the FRC7065 swivel housing but they have the mounting holes positioned to give 3 degrees of additional castor. The swivel housings are from the OEM supplier and then machined to our specification. Kit contents - Swivel housings; swivel pin bearings; gaskets; seals; plates; shims; joint washers; swivel pin uppers - non-ABS & swivel housing grease sachets.

Panhard Rods

If your Land Rover has raised suspension it is wise to use an adjustable panhard rod to correct the axle position which will in turn maintain and restore the steering geometry.

DA1130

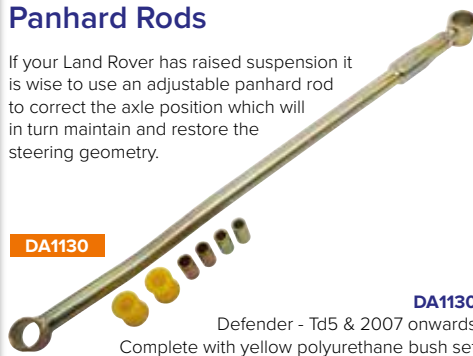

DA1130

Defender - Td5 & 2007 onwards Complete with yellow polyurethane bush set

Bush Kits

DA1247



Front bush kits include bushes for radius arms and panhard rods.

Rear bush kits include bushes for top & bottom links.

DA1242 Range Rover Classic - up to 1985 Front bush kit

DA1243 Range Rover Classic - up to 1985 Rear bush kit

DA1244 Defender - up to KA Front bush kit

DA1244G Defender - up to KA OEM front bush kit

DA1245 Defender - from LA up to VA130784/Discovery 1 Range Rover Classic - from 1986 onwards Front bush kit

DA1245G Defender - from LA up to VA130784 Range Rover Classic - from 1986 onwards OEM front bush kit

DA1246 Defender - from VA130785 up to 2A626645 Front bush kit

DA1247 Defender - from 2A626646 onwards Front bush kit

Defender to 9A768936/Discovery 1

DA1248 Range Rover Classic from 1986 on Rear bush kit

Defender to 9A768936/Discovery 1

DA1248G Range Rover Classic from 1986 on OEM rear bush kit

DA1249 Defender from 9A768937 Rear bush kit



Radius Arms

DA5505



DA5510

- > Designed for Defender/Discovery 1 Range Rover Classic with an extended 1 to 3" lift.
- > Front radius arms correct castor alignment which in turn ensures safe driving.
- > Rear radius arms provide full rear axle articulation.
- > Fitting the radius arms will contribute to much better off-road capability for your vehicle by fully utilising your spring and shock absorber set.
- > Zinc passivated with a yellow heavy-duty powder coating finish to complement each component and the Britpart coil springs.

DA5505	3° Heavy-duty	Narrow
	Use with NTC7307 & DA2353 bushes	38mm
DA5506	3° Heavy-duty	Wide
	Use with NTC6781 & DA2353 bushes	45mm
DA5510	2" Lift rear radius arm	

DA5505



Suspension Arm & Bolt Kits

LR029304K



LR029304NB

Have all the parts you need with one easy part number when you have to change a suspension arm. Kit contains suspension arm and bolts where applicable.

Britpart Kit	OEM Kit	No Bushes or bolts*			
	RBJ500222GK		Discovery 3	Front - upper	RHS
	RBJ500232GK		Discovery 3	Front - upper	LHS
		RBJ500840NB	Discovery 3 - heavy-duty	Front - upper	RHS
		RBJ500850NB	Discovery 3 - heavy-duty	Front - upper	LHS
LR028245K	LR028245GK		Discovery 3	Front - lower	RHS
LR028249K	LR028249GK		Discovery 3	Front - lower	LHS
LR075993K	LR075993GK		Discovery 3	Front - lower	RHS
LR075995K	LR075995GK		Discovery 3	Front - lower	LHS
	LR051622GK		Discovery 3	Rear - upper	RHS
	LR051623GK		Discovery 3	Rear - upper	LHS
LR019979K			Discovery 3	Rear - lower	RHS
LR019980K			Discovery 3	Rear - lower	LHS
		RBJ500840NB	Discovery 4 - heavy-duty	Front - upper	RHS
		RBJ500850NB	Discovery 4 - heavy-duty	Front - upper	LHS
		LR075993NB	Discovery 4	Front - lower	RHS
		LR075995NB	Discovery 4	Front - lower	LHS
LR073367K	LR073367GK		Discovery 4	Front - lower	RHS
LR073369K	LR073369GK		Discovery 4	Front - lower	LHS
	LR051622GK		Discovery 4	Rear - upper	RHS
	LR051623GK		Discovery 4	Rear - upper	LHS
LR019979K			Discovery 4	Rear - lower	RHS
LR019980K			Discovery 4	Rear - lower	LHS
		RBJ500840NB	Range Rover Sport 2005 - 2009	Front - upper	RHS
		RBJ500850NB	Range Rover Sport 2005 - 2009	Front - upper	LHS
			With ACE suspension		
LR029303K	LR029303GK		Range Rover Sport 2005 - 2009	Front - lower	RHS
LR029304K	LR029304GK	LR029304NB	Range Rover Sport 2005 - 2009	Front - lower	RHS
LR029305K	LR029305GK		Range Rover Sport 2005 - 2009	Front - lower	LHS
LR029306K	LR029306GK	LR029306NB	Range Rover Sport 2005 - 2009	Front - lower	LHS

*Supplied with ball joint.

Meyle Heavy-Duty NEW

Steering and suspension components are subject to extremely high load levels, which frequently results in increased part wear and shorter replacement intervals. Required to perform reliably under these conditions our parts are therefore made in genuine Meyle heavy duty quality which means optimised products offering maximum service life and outshining OE solutions.

Bushes

LR051586HD NEW	Discovery 4
LR073366HD NEW	Discovery 4

Connecting spindle rods

QFK500020HD NEW	Discovery 3
QFK500010HD NEW	Discovery 3/Discovery 4

Stabiliser link bars

RBM500190HD NEW	Discovery 3
RGD000312HD NEW	Discovery 3/Discovery 4
	Range Rover Sport
LR014145HD NEW	Discovery 4
LR024474HD NEW	Discovery Sport
	Range Rover Evoque
LR002626HD NEW	Freelander 2
LR002876HD NEW	Freelander 2
	Range Rover Evoque
LR030048HD NEW	Range Rover L322
RBM500200HD NEW	Range Rover L322
RGD500150HD NEW	Range Rover L322
LR030047HD NEW	Range Rover L322

Suspension arms

LR028245HD NEW	Discovery 3
LR028246HD NEW	Discovery 3
LR028249HD NEW	Discovery 3
LR028250HD NEW	Discovery 3
LR075993HD NEW	Discovery 3
LR075994HD NEW	Discovery 3
LR075995HD NEW	Discovery 3
LR075996HD NEW	Discovery 3
LR029303HD NEW	Range Rover Sport - 2005 - 2009
LR029304HD NEW	Range Rover Sport - 2005 - 2009
LR029305HD NEW	Range Rover Sport - 2005 - 2009
LR029306HD NEW	Range Rover Sport - 2005 - 2009
LR029301HD NEW	Range Rover Sport - 2010 - 2013
LR029302HD NEW	Range Rover Sport - 2010 - 2013

Link assembly anti-roll bars

RBM100223HD NEW	Discovery 2
RGD100682HD NEW	Discovery 2
RBM100172HD NEW	Freelander 1
ANR3304HD NEW	Range Rover P38
RGD500140HD NEW	Range Rover Sport - 2002 - 2013

4-year guarantee for Meyle-HD!



RBM100223HD

QFK500020HD

LR002876HD

LR028250HD

OE

MEYLE

Suspension Bolt Kits



DA7202

- DA7202**
Defender - up to KA930455
Front suspension - radius arms & panhard rod bolts
- DA7200**
Defender - LA930456 to WA159806
Front suspension - radius arms & panhard rod bolts
- DA7203**
Defender - XA159807 to 2A626645
Front suspension - radius arms & panhard rod bolts
- DA7204**
Defender - 2A625546 onwards
Front suspension - radius arms & panhard rod bolts
- DA7201**
Defender - up to YA185790
Rear suspension - trailing arms & a-frame bolts
- DA7208**
Defender - YA185791 onwards
Rear suspension - trailing arms & a-frame bolts
- DA7212**
Discovery 3/Discovery 4/Range Rover Sport - 2005 - 2012
Front upper suspension arm Single
- DA7205**
Discovery 3/Discovery 4/Range Rover Sport - 2005 - 2012
Front lower suspension arm Single
- Note** - This kit includes a 1.5mm pitch threaded nut, please check the thread pitch on your drive shaft before changing. If you require the 2mm pitch nut please order LR024151.
- DA7207**
Discovery 3/Discovery 4/Range Rover Sport - 2005 - 2012
Rear upper suspension arm Single
- DA7206**
Discovery 3/Discovery 4/Range Rover Sport - 2005 - 2012
Rear lower suspension arm Single



Brackets, Mounts & Ancillary Products

Shock Absorber Brackets & Turrets

Sometimes off-road conditions can be serious enough to test the standard equipment on your Land Rover...



DA1186

- Defender/Discovery 1
Range Rover Classic
DA1186
Galvanised standard height front shock turrets with fitting kit.
- NRC6372GALV**
Galvanised standard height front shock turret - single
- NRC9700GALV**
Galvanised spring seat - single

- DA1164**
Heavy-duty, plus 30mm, front turrets for Discovery 2. Finished in heavy-duty powder coating. Complete with nuts and bolts.



DA6322

DA6322L

DA6324

DA6323

DA6323L

Kit includes nuts, bolts & washers



facebook.com/britpart

DA6322	Defender/Discovery 1/Range Rover Classic*	Twin shock turrets	Front	Standard height
DA6322L	Defender/Discovery 1/Range Rover Classic*	Twin shock turrets	Front	2" Lift
DA6323	Defender/Discovery 1/Range Rover Classic*	Single shock turrets	Front	Standard height
DA6323L	Defender/Discovery 1/Range Rover Classic*	Single shock turrets	Front	2" Lift
DA6324	Defender/Discovery 1/Range Rover Classic*	Twin shock brackets - kit	Rear	

Sometimes off-road conditions can be serious enough to test the standard equipment on your Land Rover to its maximum. One of the critical components that takes most of the abuse is the suspension system. When using the standard single shock absorber configuration it is not unknown for the shock absorber to break the factory fitted turret mount. These shock absorber turrets from Britpart give you confidence that your vehicles suspension will tackle the terrain you take it through with greater ease.

The single shock absorber turret is manufactured from heavy-duty steel and replaces the existing turret mount which is susceptible to corrosion by allowing a build up of dirt inside which is hard to clean thoroughly. The new design is harder wearing and easier to clean.

The twin shock absorber turret is manufactured from the same quality steel as the single shock absorber turret but allows for the fitting of an additional shock absorber. The benefits of having extra shock absorbers fitted to your Land Rover is that any extreme force encountered is divided between the two shock absorbers for a more comfortable ride for you and your passengers. Using twin shocks is also beneficial when carrying loads both on and off-road as it improves the load carrying ability of the vehicle. An additional benefit is that when changing shock absorbers there is no need to remove the turrets.

***Note** - Rear brackets involve some welding to fit. Fitting shock absorber brackets may require some vehicle modification, please ask distributor for full details.

DA6337



- DA6337**
Defender/Discovery 1/Range Rover Classic
Long travel rear shocker absorber mounting kit

The standard pin and eye shock absorbers don't have the necessary articulation for extreme off-road conditions and the answer is to use pin and pin shock absorbers. If you use our Cellular Dynamic Plus 5 shock absorbers they offer better articulation. Laser cut, jigged and computer welded with zinc plated and powder coated finish. To be used in conjunction with DC6000LL.

Note - On Defender Td5 the fuel filter must be moved.

Adjustable Ball Joint



ANR1799A
Defender/Discovery 1/Range Rover Classic
An adjustable A-frame ball joint
Single

Spring Retainers

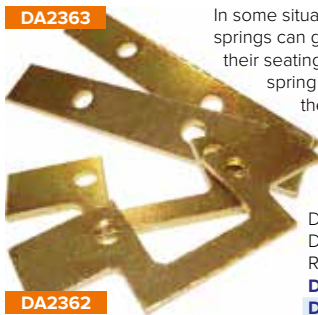

In some situations the vehicle's springs can get dislodged from their seating, these heavy-duty spring retainers ensure the springs are kept in the correct position.

Defender
Discovery 1
Range Rover Classic
DA2362 Front
DA2363 Rear

Dislocation Cones



These clever products ensure your springs relocate correctly when using your Land Rover in extreme conditions. Manufactured from stainless steel. Use in conjunction with spring retainers.

DA2186 Defender 90/Discovery 1 Rear Pair
DA1962 Defender 110 Rear Pair

Rear Spring Seats

Galvanised rear spring seat fitting kits

DA1215
Defender - 90
Discovery 1
Range Rover Classic
DA1233
Defender - 110 & 130
NRC9700GALV
Galvanised spring seat - single



Turret Rings

DA6338

Defender
Discovery 1
Range Rover Classic

These robust & heavy-duty front shock absorber turret rings are made to replace the existing standard turret rings.



Spring Spacer Blocks



Defender - 90/Discovery 1/Range Rover Classic
These 50mm spring spacer blocks are manufactured from 6mm plate with a powder coated finish. The spacers fit between the axle and the spring seats on the front and rear to give you that extra 50mm of lift you need.

DA6344 Front pair
DA6345 Rear pair



Discovery 2
These 40mm spring spacer blocks are machined from high quality aluminium and anodised deep blue.

DA6341 Front pair
With this kit you are able to retain the standard springs and shock absorbers. Use in conjunction with DA6342.

DA6342 Rear pair
This kit enables you to retain your air springs yet give your vehicle the desired 40mm lift. We recommend that this kit be fitted in conjunction with DA6341, DA4198 or DA4199. Please look at the shock absorbers suitable for this vehicle and at 40mm braided brake hoses.

Lift Rod Kit



DA7531
Fully adjustable suspension lift rod kit
Discovery 3/Discovery 4/Range Rover Sport - 2005 - 2013

"The ease of changing the ride height is what separates these rods from others in the marketplace."

These adjustable rods replace the plastic and rubber parts Land Rover supply on the vehicle. Made from aluminium with an industrial heavy grade rubber bushing, the aluminium parts are anodised black to help with corrosion protection and blending in when in the garage for work. The lift rods have two settings; standard and off-road. With the air suspension set to normal driving height the lengthened rods will give you standard road and off road driving heights. If you shorten the rods the standard ride height will be approx 50mm higher. If you select off-road height the vehicle will be in the 'super extended' position. No tools are required and should take no more than 2 minutes to do all four rods. Access to the front is over the front wheels and for the back is through the rear wishbones (blanket required!)

Note - If run for a long time in off-road position then wheels may need realigning.



Photo courtesy of Paul Coene

Bushes

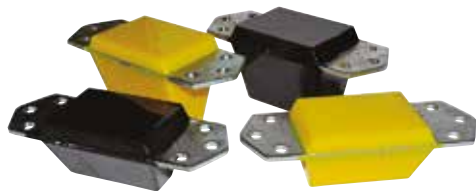

Defender & Discovery 1

ANR4188PY	Front	Standard	Black
ANR4188PY-YELLOW	Front	Standard	Yellow
ANR4189PY	Rear	Standard	Black
ANR4189PY-YELLOW	Rear	Standard	Yellow
ANR4188PYE	Front	Extended	Black
ANR4188EYELLOW	Front	Extended	Yellow
ANR4189PYE	Rear	Extended	Black
ANR4189EYELLOW	Rear	Extended	Yellow

Note - All sold individually. Standard height - 56mm high. Extended height - 80mm high.

Bush Sets - Polybush

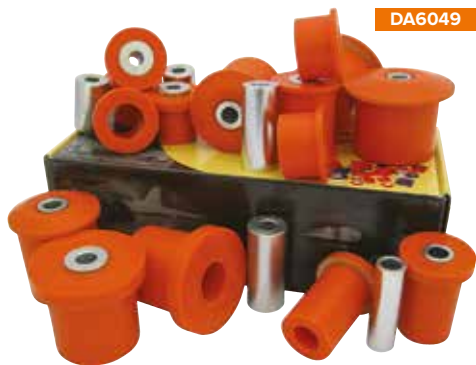

DA6049

DA3144

Full Polybush Dynamic Orange kit
Discovery 3 & Discovery 4

Kit contains -

Front lower wishbone - front & rear bushes; front upper wishbone bushes; rear lower wishbone - front & rear bushes; rear upper wishbone - front & rear bushes

Individual Polybush Dynamic Orange kits
Discovery 3 & Discovery 4

RBX000571PY	Front anti-roll bar clamp kit
RGX500060PY	Rear anti-roll bar clamp kit
RBX500301PY	Front upper wishbone kit
LR056964PY	Front upper wishbone kit
RBX500311PY	Front lower wishbone - front kit
LR051585PY	Front lower wishbone - front kit
LR051586PY	Front lower wishbone - rear kit
LR073366PY	Front lower wishbone - rear kit
RGX500101PY	Rear lower wishbone - front kit
RGX500290PY	Rear lower wishbone - front kit
RGX500111PY	Rear lower wishbone - rear kit
LR054831PY	Rear lower wishbone - rear kit
RGX500121PY	Rear upper wishbone - rear kit
RGX500300PY	Rear upper wishbone - front kit
LR051621PY	Rear upper wishbone - front kit
ROA000022PY	Damper kit

DA2220



DA2198 Defender 2002 on Red
Kit contents - Front radius arm/axle; front radius arm/chassis; panhard rod; rear radius arm/axle; rear radius arm/chassis

DA2204 Discovery 2 Orange Dynamic
Kit contents - Front radius arm to axle; front radius arm to chassis; front panhard rod; rear axle - watts link to chassis bush; rear radius arm to chassis; rear radius arm to axle

DA2200 Freelander 1 Orange Dynamic
Kit contents - Anti roll bar clamp; rear radius arm to chassis; rear radius arm to hub carrier; rear lower wishbone rear arm - inner and outer and front arm outer; rear lower wishbone front arm inner; front wishbone front bush; front lower wishbone - rear bush; front lower wishbone - rear retaining washer

DA2203 Range Rover P38 1994 on Blue Comfort
Kit contents - Front radius arm to axle; front radius arm to chassis; panhard rod; rear radius arm to chassis

Bump Stops



Extended polyurethane bump stops should be used on vehicles with raised suspension to prevent the shock absorbers from bottoming out.

Discovery 2

DC7112	Front/Rear	Standard	Black
DC7012	Front/Rear	Standard	Yellow
DC7113	Front/Rear	Extended	Black
DC7013	Front/Rear	Extended	Yellow

Note - Set of 4 stops. Standard height - 60mm high. Extended height - 90mm high.



Other Polybush sets available from Britpart - full details supplied on request.

DA8899

Full Polybush Dynamic Orange kit
Freelander 2/Discovery Sport/Range Rover Evoque

Kit contains -

Front wishbone - front & rear bushes; rear trailing arm - inner & outer (hub end) bushes; rear forward track arm - inner & outer bushes; rear rear track arm - inner & outer bushes

Individual Polybush Dynamic Orange kits
Freelander 2/Discovery Sport/Range Rover Evoque

LR005649PY	Front anti-roll bar bush kit
LR005648PY	Rear anti-roll bar bush kit

DA6049

Full Polybush Dynamic Orange kit
Range Rover Sport - 2005 - 2013
Kit contains -
Front lower wishbone - front & rear bushes; front upper wishbone bushes; rear lower wishbone - front & rear bushes; rear upper wishbone - front & rear bushes

DA8897

Full Polybush Dynamic Orange kit
Range Rover L322
Kit contains -
Front - front wishbone arm inner & rear wishbone arm inner; Rear - upper wishbone inner front and rear; lower wishbone inner front & lower wishbone inner rear

DA2220

Polybush Classic Red
Suspension bush set - wide bushes
Defender 90 & 110 - 1994 onwards
Discovery 1
Range Rover Classic - 1986 onwards
Kit contains -
Axle - front radius arm/rear radius arm & panhard rod.
Chassis - front radius arm & rear radius arm

Bush Fitting Tool



LRT-60-004

Fitting new front radius arm bushes (part number ANR3332) for the Range Rover P38A is impossible to do without using the Land Rover special tool.

Bush Set - Watts Linkage

RGX100960K



RGX100960K

Discovery 2

Watts rear linkage bush set contains bushes to replace centre bearing, top & bottom bush links and axle end links.

DA1199



DA1199

Discovery 2

This replacement pivot for the rear suspension is complete with bushes fitted which makes an awkward job easier.

Bush Sets - Castor Correction

DA8952



Defender/Discovery 1/Range Rover Classic
Old Man Emu replacement bushes to correct the castor angle after a Land Rover has been lifted. These will ensure the correct steering geometry is maintained.

DA8952 Wide bush - 44mm

DA8951 Narrow bush - 38mm

Bushes - Meyle Heavy-Duty

Steering and suspension components are subject to extremely high load levels, which frequently results in increased part wear and shorter replacement intervals. Required to perform reliably under these conditions our parts are therefore made in genuine Meyle heavy duty quality which means optimised products offering maximum service life and outshining OE solutions.



LR051586HD NEW

Discovery 4

LR073366HD NEW

Discovery 4



Bush Sets - Britpart Polyurethane

Britpart Individual Polyurethane Bush Sets

548205PY	Shackle & spring
548205PY-YELLOW	Shackle & spring
552818PY	Shock absorber
552818PY-YELLOW	Shock absorber
552819PY	Shock absorber
552819PY-YELLOW	Shock absorber
568858PY	Steering damper
568858PY-YELLOW	Steering damper
569746PY	Rear chassis
569746PY-YELLOW	Rear chassis
572068PY	Radius arm to chassis - outer
572068PY-YELLOW	Radius arm to chassis - outer
572180PY	Bottom link to chassis
572180PY-YELLOW	Bottom link to chassis
575580PY	Panhard rod
575580PY-YELLOW	Panhard rod
90577434PY	Rear chassis
90577434PY-YELLOW	Rear chassis
ANR1721PY	Damper mounting
ANR1721PY-YELLOW	Damper mounting
ANR2563PY	Radius arm to chassis
ANR2563PY-YELLOW	Radius arm to chassis
ANR3285PY	Trailing arm rear suspension
ANR3285PY-YELLOW	Trailing arm rear suspension
ANR3305PY	Anti-roll bar
ANR3305PY-YELLOW	Anti-roll bar
ANR3332PY	Radius arm to axle
ANR3332PY-YELLOW	Radius arm to axle
ANR3410PY	Panhard rod
ANR3410PY-YELLOW	Panhard rod
ANR6947PY	Radius arm to axle
ANR6947PY-YELLOW	Radius arm to axle
EGP1889PY	Rear anti-roll bar
NRC4514PY	Radius arm to chassis
NRC4514PY-YELLOW	Radius arm to chassis
NRC5593PY	Damper mounting
NRC5593PY-YELLOW	Damper mounting
NTC1772PY	Lower arm
NTC1772PY-YELLOW	Lower arm
NTC1773PY	Upper link
NTC1773PY-YELLOW	Upper link
NTC1775PY	Steering damper
NTC1775PY-YELLOW	Steering damper
NTC6781PY	Radius arm to axle
NTC6781PY-YELLOW	Radius arm to axle
NTC6860PY	Radius arm to axle
NTC6860PY-YELLOW	Radius arm to axle
NTC6828PY	Anti-roll bar
NTC6828PY-YELLOW	Anti-roll bar
NTC7307PY	Radius arm to axle
NTC7307PY-YELLOW	Radius arm to axle
NTC7394PY	Anti-roll bar
NTC7394PY-YELLOW	Anti-roll bar
RBX101240PY	Anti-roll bar
RBX101240PY-YELLOW	Anti-roll bar
RBX101340PY	Panhard rod
RBX101340PY-YELLOW	Panhard rod
RBX101680PY	Radius arm to axle
RBX101680PY-YELLOW	Radius arm to axle
RBX101690PY	Anti-roll bar
RBX101690PY-YELLOW	Anti-roll bar

RBX101730PY	Radius arm to chassis
RBX101730PY-YELLOW	Radius arm to chassis
RBX101780PY	Lower arm
RBX101780PY-YELLOW	Lower arm
RBX101790PY	Lower arm
RBX101790PY-YELLOW	Lower arm
RDB100080PY	Lower arm control buffer
RDB100080PY-YELLOW	Lower arm control buffer
RGX100970PY	Transverse link
RGX100970PY-YELLOW	Transverse link
RGX101000PY	Trailing link
RGX101000PY-YELLOW	Trailing link
RGX101010PY	Hub
RGX101010PY-YELLOW	Hub
RGX101020PY	Bottom link - outer
RGX101020PY-YELLOW	Bottom link - outer
RGX101440PY	Bottom link - inner
RGX101440PY-YELLOW	Bottom link - inner
RNF100090PY	Shock absorber - lower
RNF100090PY-YELLOW	Shock absorber - lower
ROA100040PY	Shock absorber - lower
ROA100050PY	Shock absorber - upper
STC618PY	Mounting lower link
STC618PY-YELLOW	Mounting lower link

Note - Part numbers without yellow as a suffix indicate the bush colour is black.

- > Britpart are proud to present an exclusive range of Yellow and Black polyurethane bushes.
- > Manufactured exclusively for Britpart using the latest Vulkollan™ polyurethane technology.
- > Machined to exact tolerances once cast to produce the highest finish available.
- > Produced in both yellow and black they are both the same compound which gives similar ride characteristics to the standard rubber bushes, but they offer improved articulation, vibration damping and last longer.
- > The black bushes are ideal for replacing individual bushes as they can be fitted without a press.
- > The DC range of kits include shock absorber and A-frame bushes.

Notes

*Kit includes front anti-roll bar bushes but these bushes aren't suitable for vehicles with ACE fitted.
**Excludes shock absorber bushes.

All bushes are manufactured using the latest Vulkollan™ polyurethane technology.

Britpart Black Suspension Bush Sets

DC7103	Series 1, 2 & 3 - excluding 3 LWB (see DC7104)
DC7104	Series 3 - LWB
DC7109	Defender - up to 1993
DC7110	Defender - 1994 - 1999
DC7108	Defender - 1999 - 2007
DC7111	Defender - 2007 onwards - up to 9A766382
DA2426	Defender - steering damper bush set
DC7100	Discovery 1
DC7101	Discovery 2/**
DC7102	Freelander 1
DC7105	Range Rover Classic - up to 1986
DC7106	Range Rover Classic - 1986 - 1994
DC7107	Range Rover P38**

Britpart Yellow Suspension Bush Sets

DC7003	Series 1, 2 & 3 - excluding 3 LWB (see DC7004)
DC7004	Series 3 - LWB
DC7009	Defender - up to 1993
DC7010	Defender - 1994 - 1999
DC7008	Defender - 1999 - 2007
DC7011	Defender - 2007 onwards - up to 9A766382
DA2425	Defender - steering damper bush set
DC7000	Discovery 1
DC7001	Discovery 2/**
DC7002	Freelander 1
DC7005	Range Rover Classic - up to 1986
DC7006	Range Rover Classic - 1986 - 1994
DC7007	Range Rover P38**

DC7108



NTC6860PY-YELLOW



> Suspension & Axle

Bush Sets - Britpart



Polyurethane Bush Sets

DA4035BLUE

Defender - 90/110/130 - up to 1993 with drum brakes

DA4036BLUE

Defender - 1994 onwards

Discovery 1

Range Rover Classic - 1986 onwards

Rubber Bush Set

Front radius arm to chassis kit

Defender - 1987 - 1997/Discovery 1/
Range Rover Classic - 1986 - 1994

DA2353 - Britpart

DA2353G - OEM



Photo courtesy of Ray Cully

Bush Sets - Powerflex



LR051586PF

Discovery 3/Discovery 4

Front arm - lower - rear

LR073366PF

LR051585PF

Discovery 3/Discovery 4

Front arm - lower - front

RBX500311PF

- > Better handling
- > Better stability under braking
- > Prolong tyre life
- > High quality polyurethane material
- > Last longer (up to 10 x rubber equivalent)
- > Easily fitted

Powerflex bushes offer improved performance, safety and prolong tyre life. Engineered to be the best, Powerflex bushes are an answer to soft ageing and failing rubber suspension bushes and provide improved suspension mountings. No special tools are needed and comprehensive fitting instructions are included.

Air Suspension Compressors

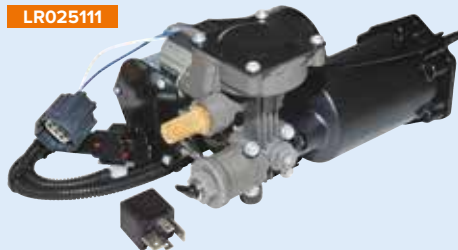

At last, a cost effective and easy way to replace the OE air suspension compressor. These compressors are a direct replacement fit for the OE compressors that were fitted by the factory. They are made in Japan by Hitachi. By using the original brackets and pipes they are easy to install. The relay, which is included, must be changed. No need to reprogram the ECU (fault codes may need to be cleared).

- > Direct replacement fit
- > Cost effective
- > No need to reprogram the air suspension ECU
- > Uses all original mounting & pipework

DA3965

Complete Hitachi compressor kit

Discovery 3 - up to 9A513325

Range Rover Sport - up to 9A215622

LR023964 - compressor & relay

RQU500064 - compressor bracket

DA3964 - compressor pipe/install kit

Plus - bolts, nuts, clips & mounting rubbers

LR015303 & LR023964

Hitachi compressor & relay

Discovery 3 - up to 9A513325

Range Rover Sport - up to 9A215622

LR023964G NEW

Hitachi compressor & genuine Land Rover relay

Discovery 3 - up to 9A513325

Range Rover Sport - up to 9A215622

LR015089 & LR025111

Hitachi compressor & relay

Range Rover L322 - from 6A198058 up to CA393639

DA3964

Hitachi compressor pipe/install kit



LR078650



Discovery 3

Discovery 4

Range Rover Sport - Mk1

A direct replacement AMK compressor for all non-Hitachi vehicles. Manufactured by the OE company in Germany. The relay, which is included, must be changed.

LR072537

AMK compressor, compressor covers, relay, bracket, wiring & fixings

LR078650

AMK compressor, relay, bracket & fixings

LR044034

Bracket only

DA1888

AMK compressor pipe/install kit

Shock Absorbers

Britpart XD Remote Reservoir

BRITPART XD

Britpart have developed this range of remote reservoir shock absorbers for users wanting the extra benefits of a remote reservoir shock absorber on a vehicle that is used both on and off-road. The remote reservoir allows the shock to remain cooler under more extreme conditions and hence reduces the possibility of fade. Unlike most remote reservoir shock absorbers on the market the Britpart XD remote reservoir shock absorbers use conventional rubber bushings instead of ball joints. This is because ball joints have a very short life span when used on a road vehicle and are more suited to an all out competition vehicle.



Nitrogen filled remote reservoir shock absorbers with zinc plated steel body and anodised fittings.

Note - Will require extra fabrication to fit.

Defender 90 & 110/Discovery 1/Range Rover Classic

Body diameter - 51mm
 Shaft diameter - 20mm
 Hydraulic hose length - 600mm

		Open length	Closed length
DC8000	Front pair	716mm	462mm
DC8001	Rear pair	717mm	463mm



DC8000



DA6323XD

Shock absorber turrets for use with the Britpart XD Remote Reservoir Shock Absorbers - DC8000 Front



DC8001

Britpart Heavy-Duty

Heavy-duty oil filled shock absorbers

DA4211	Front
Defender 90/110	
DA4210	Rear
Defender 90/110	
RTC4234	Front
Series 2/2A/3 - SWB	
RTC4235	Rear
Series 2/2A/3 - SWB	
RTC4484	Front
Series 2/2A/3 - LWB	
RTC4236	Rear
Series 2/2A/3 - LWB	



DA4210



RTC4236



RTC4235



RTC4484



Sign up to the regular Britpart newsletter to find out about all the latest product releases.

www.britpart.com/newsletter

Britpart Cellular Dynamic

	Application	Lift	Fitment	Open/Closed Dimensions**
DC6000	Defender/Discovery 1/Range Rover Classic		Front	600/380mm
DC6001	Defender/Discovery 1/Range Rover Classic		Rear	590/375mm
DC6000L	Defender/Discovery 1/Range Rover Classic	50mm/2"	Front	665/425mm
DC6001L	Defender/Discovery 1/Range Rover Classic	50mm/2"	Rear	625/385mm
DC6000LL	Defender/Discovery 1/Range Rover Classic	125mm/5" (see note***)	Front	765/455mm
DC6001LL	Defender/Discovery 1/Range Rover Classic	125mm/5" (see note***)	Rear	750/440mm
DC6010	Discovery 2		Front	590/370mm
DC6011	Discovery 2		Rear	585/365mm
DC6002	Range Rover P38 - air suspension		Front	560/365mm
DC6003	Range Rover P38 - air suspension		Rear	505/340mm
DC6004	Defender		Steering damper	
DC6005	Discovery 1/Range Rover Classic/Series		Steering damper	
DC6009	Discovery 2		Steering damper	
DC6006	Range Rover P38		Steering damper	
DC6007	Replacement gaiter for DC6000LL & DC6001LL - single			



- > Cellular technology tube
- > Sintered 18mm rod
- > Piston diameter 41mm
- > Polyurethane bush
- > Teflon piston with multi-lip seal
- > Single piece eye ring

The Britpart Cellular Dynamic Shock Absorber represents a significant advance in Land Rover suspension systems. It features a cellular foam insert instead of a normal nitrogen gas or air, this is to stop the oil from boiling. The foam takes up less room which means more room for oil, 50% more, which offers maximum heat dispersion. This heat dispersion translates to a very subtle but controlled ride that will not fade no matter how hard you push them. They are ideal for a driver who needs more control to complement performance improvements or to enhance a standard vehicle. The unique design ensures ride comfort and cornering ability is maximised and of course they are superb off-road.

Notes

- *Terms & conditions apply
- ** Dimensions are +/- 5mm
- *** The Plus 5" Cellular Dynamic Shock Absorbers are specialist suspension products and to install them additional fabrication work or brackets may be required. Please ensure that they are fitted by a competent expert.



DC6001LL

"They are ideal for a driver who needs more control to complement performance improvements"



Britpart Super Gaz

	Application	Lift	Fitment	Open/Closed Dimensions**
DC5002	Defender/Discovery 1/Range Rover Classic		Front	605/385mm
DC5003	Defender/Discovery 1/Range Rover Classic		Rear	590/375mm
DC5002L	Defender/Discovery 1/Range Rover Classic	50mm/2"	Front	655/405mm
DC5003L	Defender/Discovery 1/Range Rover Classic	50mm/2"	Rear	640/400mm
DC5000	Discovery 2		Front	590/370mm
DC5001	Discovery 2		Rear	585/365mm
DC5000L	Discovery 2	50mm/2"	Front	640/400mm
DC5001L	Discovery 2	50mm/2"	Rear	635/390mm
DC5004	Defender		Steering damper	
DC5005	Discovery 1/Range Rover Classic/Series		Steering damper	



Britpart Super Gaz Shock Absorbers offer a 35mm bore tube filled with Fuchs shock absorber fluid, using the best seal available, single piece eye rings, polyurethane bush mounts and a very durable powder coated finish. These offer a vast improvement in ride quality and damping performance. They are ideal for use with either of the Britpart Yellow Spring range or standard Land Rover springs.

Notes

- *Terms & conditions apply.
- ** Dimensions are +/- 5mm



"Vast improvement in ride quality & damping performance"



24 month / 50,000 mile Warranty*

Old Man Emu

	Application	Fitment	Open/Closed Dimensions
DA8911	Defender - 90, 110 & 130	Front	553/329mm
DA8921	Defender - 90 & 110	Rear	560/346mm
DA8913	Defender - 90 & 110	Rear - heavy-duty	560/346mm
DA8913	Defender - 130	Rear	560/346mm
DA8911	Discovery 1	Front	553/329mm
DA8921	Discovery 1	Rear	560/346mm
DA8913	Discovery 1	Rear - heavy-duty	560/346mm
DA8916	Discovery 2	Front	587/368mm
DA8917	Discovery 2	Rear	587/368mm
DA8911	Range Rover Classic	Front	553/329mm
DA8921	Range Rover Classic	Rear	560/346mm
DA8913	Range Rover Classic	Rear - heavy-duty	560/346mm



- > Impact resistant polymer dirt shield.
- > Balanced, 35mm Teflon banded piston assembly.
- > Teflon coated low friction glacier piston rod guide.
- > 18-25mm induction hardened chrome piston rod.
- > High quality replacement mounting bushes.
- > Australian made and engineered.

Nitrocharger Sport shock absorbers introduces advanced dual-stack deflective disc technology that continuously adapts to the terrain, offering rapid response improvements to ride quality, handling and control. Available in the UK only.

Features

- > Interactive, multi-stacked rebound and compression valving systems ensure optimal damping performance in all conditions.
- > Vehicle specific fine tuning for superior handling and ride performance.
- > Piston rod 'slip ring' provides more consistent and uniform damping performance.
- > Triple lipped oil seal with gas retention check valve design virtually eliminates contaminant damage and gas loss.

Replacement Old Man Emu Shock Absorber Bushes

DA6803 NEW	Upper mount bush for DA8916 & DA8917
	Lower mount bush for DA8917
DA6804 NEW	Lower mount bush for DA8916
DA6805 NEW	Upper and lower mount bush kit for DA8911
DA6806 NEW	Lower mount bush kit for DA8913 & DA892

Boge

RTC4483B/RTC4484B NEW	Series 2/2A/3	LWB - heavy-duty	Front
STC3766B	Defender - from VA998900 to WA159806	90	Front
STC3767B	Defender - up to WA159806	90	Rear
RSC100040B	Defender - XA159807 onwards	90	Front
RPM100070B	Defender - XA159807 onwards	90	Rear
RTC4639B	Defender - up to HA478284	110 - normal duty	Rear
STC3769B	Defender - from VA998900 to WA159806	110/130	Front
STC3770B	Defender - up to WA159806	110 - self levelling suspension	Rear
STC3771B	Defender - up to WA159806	110 - normal duty	Rear
STC3772B	Defender - up to WA159806	110 - heavy-duty	Rear
RSC100050B	Defender - XA159807 onwards	110/130	Front
RPM100080B	Defender - XA159807 onwards	110/130	Rear
STC3772B	Defender - up to WA159806	130	Rear
STC3703B	Discovery 1		Front
STC3939B	Discovery 1 - up to LA081991		Rear
STC3704B	Discovery 1 - MA1359578 onwards		Rear
STC2830B NEW	Range Rover Classic - from MA660164 - with air suspension		Front
STC3939B	Range Rover Classic		Rear
STC3672B	Range Rover P38 - VA348054 onwards		Front
STC3671B	Range Rover P38 - VA348054 onwards		Rear



**Your Partner
in Quality**

BOGE shock absorbers offer customers great quality! The technical characteristics are exactly tailored to the vehicle specifications and will contribute to a noticeable improvement in the handling of the vehicle. High quality materials and sophisticated manufacturing processes guarantee the best quality and comfort for your vehicle.

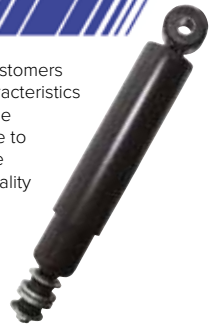

Bilstein



Bilstein rear shock absorbers		
LR031667G NEW	Freelander 2	RHS
LR031665G NEW	Freelander 2	LHS
LR023573	Range Rover L322 - 2010 - 2012	RHS
LR023580	Range Rover L322 - 2010 - 2012	LHS



Photo courtesy of Cyril Mischler

Springs



DA5011

Air Lift Kits

Adjustable Air Helper Springs - The load and towing problem solver

Air adjustability is the difference! Stiff steel factory suspensions must compromise between ride comfort and load hauling capacity. Smooth ride suspensions can't carry heavy loads; heavy springs ride rough, especially when the vehicle is unloaded. Air Lift adjustable air springs solve these problems by allowing you to tune your suspension under all load and road conditions. Just add air when towing or hauling and then remove air for a softer ride when unloaded.

Features & benefits of Air Lift 1000

- > Improve ride, handling and stability by reducing roll, sway and "bottoming out"
- > Fits open coil springs, front or rear
- > Up to 1,000lbs of levelling capacity
- > Tough long-lasting moulded polyurethane construction
- > Quick connecting easy-to-use engineered polymer air fittings

DA5010

Defender 110 /130

DA5011

Defender 90/Discovery 1/Range Rover Classic



DA5012

DA5012

Load Controller II

The economical, popular, basic on board air system. This system controls the rear bags equally. All kits include wiring harness for fast, easy installation. To eliminate the major cause of air spring failure, the low pressure sensor automatically activates if pressure falls below the minimum safe level.

DA5010 / DA5011



Springs - Air



DA2373

DA2372

Air springs can be susceptible to air leaks due to the fact the rubber seals dry out. Why not firm up your suspension and replace them with these quality air springs from Britpart?

RKB101200	Discovery 2	Rear
NTC9820	Range Rover Classic	Rear
DA2372	Range Rover P38	Front
DA2373	Range Rover P38	Rear
REB101740	Range Rover P38	Front
RKB101460	Range Rover P38	Rear

Note - All sold individually.

Springs - Leaf

For many years Land Rover road springs have been difficult to obtain to the correct OE specification. To remedy this, Britpart commissioned the same Spanish factory that produces our Santana parabolic springs to reproduce a comprehensive range of springs for Land Rover Series vehicles. The springs are constructed from the correct grade alloy steel 60SiCr8, heat treated consisting of hardening & tempering and set as Land Rover engineers specified and therefore will give years of service with the correct ride comfort.

241283	SWB	Petrol	Front	9 Leaf	O/S
242863	SWB	Petrol	Front	9 Leaf	N/S
265627	SWB & LWB	Diesel	Front	11 Leaf	O/S
264563	SWB & LWB	Diesel	Front	11 Leaf	N/S
517588	SWB		Rear	11 Leaf	O/S
517589	SWB		Rear	11 Leaf	N/S
243123	SWB		Rear	Single main leaf	O/S & N/S
279678	LWB		Rear	10 Leaf	O/S
279679	LWB		Rear	10 Leaf	N/S
535173	LWB - 1 Ton		Rear	9 Leaf	O/S & N/S
562631	Lightweight		Rear	7 Leaf	O/S
562632	Lightweight		Rear	7 Leaf	N/S



265627

"Quality you would expect from an OEM supplier..."



279678

Springs - Parabolic

The Britpart range of high quality OEM parabolic springs are made to the exacting specifications as fitted to Santana specification vehicles. Manufactured in Spain to the standard and quality you would expect from an OEM supplier. The correct grade alloy steel 60SiCr8 is used, heat treated consisting of hardening & tempering and springs are shot peened before painting. These parabolic springs will bring a comfortable ride and improved handling to your Series vehicle.

Note - Includes 'U' bolts and nuts.

DA4106	Series - SWB/LWB	2 Leaf	Front kit pair
DA4107	Series - SWB	3 Leaf	Rear kit pair
DA2003	Series - LWB	4 Leaf	Rear kit pair



DA4107



DA4106

Leaf Spring Castor Correction Wedges



DA1211
Castor correction wedges - pair
Small pin - 13mm

DA1212
Castor correction wedges - pair
Large pin - 16mm

Can be used to correct castor or diff pin angle on leaf sprung vehicles by 3 degrees.



Old Man Emu

- > Manufactured from state of the art micro-alloyed spring steel for superior strength and durability.
- > Double scragged before and after shot peening to reduce spring stress and enhance spring life.
- > Exceptional resistance to sagging and corrosion.
- > Springs are designed for each vehicle to match the spring to the specific applications.
- > Springs formed on computer controlled, precision mandrels to ensure manufacturing consistency.
- > Spring end configurations designed to exact specifications, guaranteeing perfect fitment to your vehicle.
- > Durable, hard wearing black powder coat.
- > Designed and manufactured in Australia.

Notes

Caution - Due to altered gearbox mounts on models after 1998 any lift above OE ride height may cause front driveline vibration that can only be rectified by fitting of a front double cardan propshaft. On vehicles fitted with an OE inner helper coil such as fitted to some 110 and 130 models. The inner coil must be retained with Old Man Emu coils. Important: DA8922 has reduced spring rate from OE to provide improved ride quality for light loads. Available in the UK only.



					Spring Rate		Free
			Load	Lift	lbf/in	N/mm	Height
Defender							
DA8910	Defender - 90/110/130 - diesel	Front	50kg	Up to 40mm	225	39	390mm
DA8924	Defender - 90 - diesel	Front	51 - 110kg	Up to 40mm	285	50	385mm
DA8914	Defender - 90/110 - petrol	Front	50kgs	Up to 40mm	200	35	400mm
DA8910	Defender - 90/110 - petrol	Front	51 - 110kg	Up to 40mm	225	39	390mm
DA8920	Defender - 90	Rear	100kg	Up to 40mm	220	39	430mm
DA8912	Defender - 90	Rear	200kg	Up to 40mm	300/340	52/60	420mm
DA6841	Defender - 110	Rear	Station Wagon	Up to 40mm	175/200	31/35	440mm
DA8922	Defender - 110	Rear	300kg	Up to 50mm	300	52	435mm
DA8923	Defender - 110	Rear	500kg	Up to 55mm	420	74	435mm
DA8922	Defender - 130	Rear	Light Load	Up to 50mm	300	52	435mm
DA8923	Defender - 130	Rear	400kg	Up to 55mm	420	74	435mm
Discovery							
DA8910	Discovery 1 - diesel	Front	50kg	Up to 40mm	225	39	390mm
DA8914	Discovery 1 - petrol	Front	50kg	Up to 40mm	200	35	400mm
DA8924	Discovery 1	Front	51 - 110kgs	Up to 40mm	285	50	385mm
DA8920	Discovery 1	Rear	Medium	Up to 40mm	220	39	430mm
DA8912	Discovery 1	Rear	100kg	Up to 40mm	300/340	52/60	420mm
DA8915	Discovery 2	Front	21 - 50kg	Up to 40mm	180	32	395mm
DA8912	Discovery 2	Rear	100kg	Up to 40mm	300/340	52/60	420mm
DA8918	Discovery 3	Front	Standard	Up to 50mm	530	93	400mm
DA8919	Discovery 3	Rear	Medium	Up to 50mm	680	119	370mm
Range Rover							
DA8910	Range Rover Classic - diesel	Front	50kg	Up to 40mm	225	39	390mm
DA8914	Range Rover Classic - petrol	Front	50kg	Up to 40mm	200	35	400mm
DA8924	Range Rover Classic	Front	51 - 110kg	Up to 40mm	285	50	385mm
DA8920	Range Rover Classic	Rear	Medium	Up to 40mm	220	39	430mm
DA8912	Range Rover Classic	Rear	100kg	Up to 40mm	300/340	52/60	420mm

Springs - Lowered Coils & Kit

Reduce the ride height of your Land Rover by 1" (25mm). By lowering your vehicle it will help reduce body roll as well as giving your vehicle a more sporty squat stance and improve handling. The springs are designed in line with the standard spring rate specification and are finished in powered coated orange paint to match the anti-roll bars and shock absorbers.

- DA4563**
Defender 90/110
Discovery 1
Range Rover Classic
Front springs
Pair
- DA4564**
Defender 90
Discovery 1
Range Rover Classic
Rear springs
Pair
- DA6449**
Defender 110
Rear springs
Pair



DA1234

XD Handling Kit
Defender 90 / Discovery 1
Range Rover Classic with axle brackets
Kit contains -

- > Britpart lowered coil springs
- > Britpart Cellular Dynamic shock absorbers
- > Anti-roll bars
- > Turret rings
- > Straps
- > Ball joint assemblies
- > Bushes
- > Nuts, bolts and washers

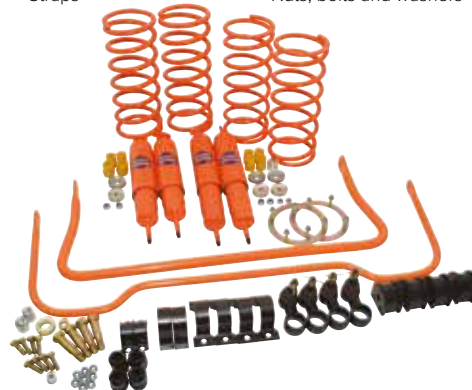

DA5135 NEW
Range Rover Evoque
4WD 2.0 Si4/2.2
TD4/2.2 SD4
35mm Lowering
springs kit
Front & rear



Springs - Britpart Coil



Britpart Performance - Lifted Springs

Britpart performance springs are high quality, versatile and competitively priced - the right choice when replacing the old sagging original springs.

Developed by one of the world's top spring manufacturers these high quality, powder coated yellow springs have been designed with the needs of today's Land Rover owners in mind. Britpart performance lifted springs have the added benefit of improving your vehicles approach and departure angles which in turn allows you to overcome more obstacles when off-roading.

As Land Rovers are often working vehicles as well as the family car, uprated springs must offer the ability to carry loads, handle off-road terrain and provide a good ride on road. The progressive springs offer a compliant ride when lightly loaded, but firm up as the load increases.

Note - Spring quantity 1 = 1 pair

The right choice when replacing the old sagging original springs!

			Lift	Load	Bar Diameter	Rate lbs/in	Free Height
Defender							
DA4201	Defender 90/110	Front	25mm	25kg	16mm	200	420mm
DA4202	Defender 90/110/130	Front	40mm	50kg	16mm	230	390mm
DA4203	Defender 90	Rear	40mm	Light	17mm	220	435mm
DA4204	Defender 90	Rear	50mm	100kg	18mm	300 - 340	425mm
DA4205	Defender 90	Rear	50mm	200kg	19mm	360	430mm
DA4206	Defender 110	Rear	40mm	100kg	17mm	270 - 295	445mm
DA4208	Defender 110/130	Rear	50mm	500kg	21mm	420	445mm
Discovery							
DA4201	Discovery 1	Front	25mm	25kg	16mm	200	420mm
DA4202	Discovery 1	Front	40mm	50kg	16mm	230	390mm
DA4199	Discovery 2	Front	40mm	20 - 50kg	15mm	180	390mm
DA4198	Discovery 2	Front	40mm	50 - 100kg	16mm	220	390mm
DA4203	Discovery 1/Discovery 2	Rear	40mm	Light	17mm	220	435mm
DA4197	Discovery 2	Rear	40mm	Medium	18mm	290	430mm
DA4204	Discovery 1	Rear	50mm	100kg	18mm	300 - 340	425mm
DA4205	Discovery 1/Discovery 2	Rear	50mm	200kg	19mm	360	430mm
Range Rover							
DA4201	Range Rover Classic	Front	25mm	25kg	16mm	200	420mm
DA4202	Range Rover Classic	Front	40mm	50kg	16mm	230	390mm
DA4203	Range Rover Classic	Rear	40mm	Light	17mm	220	435mm
DA4204	Range Rover Classic	Rear	50mm	100kg	18mm	300 - 340	425mm
DA4205	Range Rover Classic	Rear	50mm	200kg	19mm	360	430mm



Photo courtesy of Jessica Sutherland

Britpart Performance - Standard Height Springs

Britpart yellow springs are designed for the enthusiast who wants a performance spring without having to raise the vehicle. They offer a firmer ride with less body roll, ideal for a vehicle with uprated performance or one used for carrying heavy loads. The springs are designed to offer full articulation off-road with a compliant ride. Developed by one of the world's top spring manufacturers these high quality, powder coated yellow springs have been designed with the needs of today's Land Rover owners in mind.

Note - Spring quantity 1 = 1 pair

			Lift	Load	Bar Diameter	Rate lbs/in	Free Height
Defender							
DA4277	Defender 90/110	Front			16mm	225	390mm
DA4278	Defender 90	Rear			18mm	285	385mm
DA4279	Defender 110	Rear			19mm	330	415mm
Discovery							
DA4277	Discovery 1	Front			16mm	225	390mm
DA4278	Discovery 1	Rear			18mm	285	385mm
Range Rover							
DA4277	Range Rover Classic	Front			16mm	225	390mm
DA4278	Range Rover Classic	Rear			18mm	285	385mm

Air Spring Conversion Kits



Discovery 2

It is a sad fact that it's likely the air suspension on your Discovery 2 will fail - probably at the most inconvenient time possible. You then have a choice to make. Do you replace it with a new air spring system which is comfortable but not so comfortable on your wallet or replace with an equally comfortable but much more affordable and reliable coil spring system? Britpart have the complete kit for air to coil spring conversion making your decision that little bit easier.

DA5136	Standard ride height	Rear kit - black springs	
DA5137	2" lift ride height	Rear kit - yellow springs	
DA5007	2" lift ride height - heavy-duty	Front & rear kit - yellow springs	Ideal if winch is fitted
DA5008	2" lift ride height	Front & rear kit - yellow springs	

Range Rover P38

The EAS (Electronic Air Suspension) System found on Range Rover 4.0 and 4.6 vehicles can present expensive, recurring maintenance problems. If you've had an air spring failure before, you know this first hand. Britpart now has a coil spring conversion kit for Range Rover 4.0 and 4.6 that makes switching to coil springs seamless and error-free. Conversion to coil springs provides a better, maintenance-free ride that will save you significant money over time. The EAS Override Module suppresses all typical false dashboard display errors and buzzers seen when converting to coil springs. Any mechanic or Range Rover owner can install this coil spring conversion kit without having to go to a Land Rover dealer or Autologic-equipped repair shop to eliminate false dash warning light errors.

The kit features:

- > Detailed step-by-step instructions.
- > The EAS Override Module overrides all typical computer errors seen when converting to coil springs.
- > Eliminates the need for a costly shop visit.
- > Aluminium spring perch adapters.
- > Britpart custom made coil springs provide standard ride height and maximum articulation.
- > Affordable alternative to expensive, recurring air suspension failures.
- > Trip computer compatibility - maintains operation of your vehicle's trip computer.
- > Kit provides everything needed to complete a professional installation.

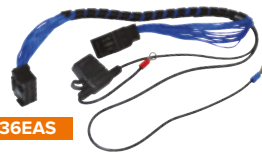

DA4136EAS

DA4136

Range Rover P38 - 1995 - 2002
Petrol models and diesel light duty

DA4136HD

Range Rover P38 - 1995 - 2002
Heavy-duty 1" lift including diesel models

DA4136BUSH

Britpart yellow polyurethane bush kit for DA4136 & DA4136HD

BL4136BUSH

Britpart black polyurethane bush kit for DA4136 & DA4136HD

DA4136FR

Pair of replacement front coil springs for DA4136

DA4136RR

Pair of replacement rear coil springs for DA4136

DA4136HDFR

Pair of replacement front coil springs for DA4136HD

DA4136HDDR

Pair of replacement rear coil springs for DA4136HD

DA4136EAS

Range Rover P38 - 1995 - 2002
EAS Override module
EAS override module suppresses all typical false dashboard display errors and buzzers seen when converting to coil springs.



Range Rover Classic

DA4180

Range Rover Classic -1" lift - no module

DA4179

Range Rover Classic - no module



Air to coil spring conversion kits from Britpart - get a reliable and maintenance-free ride for your Land Rover!



Photo courtesy of Hårm Kruyshaar

Suspension Kits

Britpart Super Gaz Suspension Kits

Shock Absorber & Spring Kits

DA4284	Defender 90/Discovery 1/Range Rover Classic	Heavy-duty	Standard height
DA4301	Defender 90/Discovery 1/Range Rover Classic	Light-duty	25mm lift
DA4286	Defender 90/Discovery 1/Range Rover Classic	Light-duty	40mm lift
DA4286MD	Defender 90/Discovery 1/Range Rover Classic	Medium-duty	40mm lift
DA4286HD	Defender 90/Discovery 1/Range Rover Classic	Heavy-duty	40mm lift
DA4285	Defender 110	Heavy-duty	Standard height
DA4287	Defender 110	Heavy-duty	40mm lift

Full Suspension Kits

DA4288	Defender 90 - up to 1994/Range Rover Classic - up to 1986	Narrow bush	Light-duty	40mm lift
DA4288MD	Defender 90 - up to 1994/Range Rover Classic - up to 1986	Narrow bush	Medium-duty	40mm lift
DA4288HD	Defender 90 - up to 1994/Range Rover Classic - up to 1986	Narrow bush	Heavy-duty	40mm lift
DA4289	Defender 90 - 1994 onwards/Discovery 1/Range Rover Classic - 1986 onwards	Wide bush	Light-duty	40mm lift
DA4289MD	Defender 90 - 1994 onwards/Discovery 1/Range Rover Classic - 1986 onwards	Wide bush	Medium-duty	40mm lift
DA4289HD	Defender 90 - 1994 onwards/Discovery 1/Range Rover Classic - 1986 onwards	Wide bush	Heavy-duty	40mm lift
DA4299	Defender 110 - up to 1994	Narrow bush	Heavy-duty	40mm lift
DA4300	Defender 110 - 1994 onwards	Wide bush	Heavy-duty	40mm lift



Britpart offers you a *complete or partial suspension package* suitable for whatever you intend to use your Land Rover for.



CELLULAR DYNAMIC - FULL SUSPENSION KIT



Full suspension kits

- > Springs - front & rear
- > Shock absorbers - front & rear
- > Radius arms - front & rear
- > Spring retainers - front & rear
- > Bush sets

SUPER GAZ - SHOCK ABSORBER & SPRING KIT



Shock absorber & spring kits

- > Springs - front & rear
- > Shock absorbers - front & rear



Britpart Cellular Dynamic Suspension Kits

Shock Absorber & Spring Kits

DA4284C	Defender 90/Discovery 1/Range Rover Classic	Heavy-duty	Standard height
DA4301C	Defender 90/Discovery 1/Range Rover Classic	Light-duty	25mm lift
DA4286C	Defender 90/Discovery 1/Range Rover Classic	Light-duty	40mm lift
DA4286CMD	Defender 90/Discovery 1/Range Rover Classic	Medium-duty	40mm lift
DA4286CHD	Defender 90/Discovery 1/Range Rover Classic	Heavy-duty	40mm lift
DA4363	Defender 90/Discovery 1/Range Rover Classic	Light-duty	Plus 5" shock*
DA4285C	Defender 110	Heavy-duty	Standard height
DA4287C	Defender 110	Heavy-duty	40mm lift
DA4364	Defender 110	Heavy-duty	Plus 5" shock*

Full Suspension Kits

DA4288C	Defender 90 - up to 1994/Range Rover Classic - up to 1986	Narrow bush	Light-duty	40mm lift
DA4288CMD	Defender 90 - up to 1994/Range Rover Classic - up to 1986	Narrow bush	Medium-duty	40mm lift
DA4288CHD	Defender 90 - up to 1994/Range Rover Classic - up to 1986	Narrow bush	Heavy-duty	40mm lift
DA4365	Defender 90 - up to 1994/Range Rover Classic - up to 1986	Narrow bush	Medium-duty	Plus 5" shock*
DA4289C	Defender 90 - 1994 onwards/Discovery 1/Range Rover Classic - 1986 onwards	Wide bush	Light-duty	40mm lift
DA4289CMD	Defender 90 - 1994 onwards/Discovery 1/Range Rover Classic - 1986 onwards	Wide bush	Medium-duty	40mm lift
DA4289CHD	Defender 90 - 1994 onwards/Discovery 1/Range Rover Classic - 1986 onwards	Wide bush	Heavy-duty	40mm lift
DA4366	Defender 90 - 1994 onwards/Discovery 1/Range Rover Classic - 1986 onwards	Wide bush	Medium-duty	Plus 5" shock*
DA4299C	Defender 110 - up to 1994	Narrow bush	Heavy-duty	40mm lift
DA4367	Defender 110 - up to 1994	Narrow bush	Heavy-duty	Plus 5" shock*
DA4300C	Defender 110 - 1994 onwards	Wide bush	Heavy-duty	40mm lift
DA4368	Defender 110 - 1994 onwards	Wide bush	Heavy-duty	Plus 5" shock*
DA1234	Defender 90/Discovery 1/Range Rover Classic - with axle brackets			1" lower

*Note - The Plus 5" Cellular Dynamic Shock Absorbers are specialist suspension products and to install them additional fabrication work or brackets may be required.

Please ensure that they are fitted by a competent expert. Open and closed dimensions - DC6000LL - 765 - 455mm & DC6000LL - 750 - 440mm.

Propshafts

Propshaft Kit

DA6355

Defender/Discovery 1/Range Rover Classic

- > 300Tdi & Td5 manual models only
- > Double cardan extreme use front propshaft with flange and fitting kit.
- > For vehicles with L230 transfer boxes.
- > Ideal for use with lifted vehicles.
- > Helps to reduce driveline vibration where diff and transfer flanges are not in-line.

Note - Flange must be fitted to transfer box.



Propshaft Spacer Kits

DA6339

15mm spacer kit

DA633925

25mm spacer kit

Defender/Discovery 1/Range Rover Classic Propshaft spacer kit machined from billet aluminium and anodised deep blue. When suspension lift kit is fitted it increases the distance between the transfer box flange and the diff flange. This increased distance can cause the propshaft to run out of spline travel.

DA633925



Fitting this prop spacer helps return the propshaft to its normal operating length therefore allowing full spline travel which also helps reduce the characteristic "binding" of the yokes when a propshaft is over extended.

Wide Angle Propshafts

If your Land Rover has raised suspension or been modified for extreme axle articulation then the joints on the existing propshaft will become strained. This will cause the propshaft to lock up or vibrate and wear the universal joints prematurely. Dropping the axle further away from the chassis is great for looks, articulation and off-road performance - a neat solution is to fit a wide angle propshaft. This allows drivetrain angles of up to 32 degrees which reduces vibration, universal joint 'bind-up' and premature wear on the joints. These wide angle shafts have greasable universal joints which are more desirable where longer life is required.

DA6350	Front	Defender - from MA - 300Tdi & Td5/Discovery 1/Range Rover Classic - 1986 - 1991	FRC8386
DA6352	Front	Defender - up to LA (1993)	FRC8390/FRC5566
DA6351	Rear	Defender 90 - 4 cylinder	FRC8392
DA6353	Rear	Defender 90 - V8 - up to 2007 & diesel from MA	FRC8393
DA6354	Rear	Discovery 1 - 1989 - 1994 & V8 from 1997	FRC8387
DA6356	Replacement heavy-duty universal joint for wide angle propshafts		
DA1123	Nut & bolt kit - each kit contains 4 nuts - for transfer box end & 4 nuts & bolts - for diff end. Enough nuts & bolts to make propshaft repair out in the field. Suitable for DA6350; DA6351; DA6352, DA6353 & DA6354.		



Steering

Steering Dampers

Britpart Cellular Dynamic

DC6004	Defender
DC6005	Discovery 1/Range Rover Classic/Series
DC6009	Discovery 2
DC6006	Range Rover P38

Britpart Super Gaz

DC5004	Defender
DC5005	Discovery 1/Range Rover Classic/Series



Old Man Emu

DA8925	Defender 90, 110 & 130
DA3066	Discovery 1
DA3135	Discovery 2
DA3066	Range Rover Classic

Features

- > 9 stage valving for optimum performance.
- > Massive 35mm bore.
- > Stone guard.
- > Fits original mounts.
- > 50/50 valving.



DA8925

Steering dampers with nitrogen charged foam cell for reduced wheel vibration and improved handling and control. Available in the UK only.

Heavy-Duty Steering Arms

- > Solid heavy-duty arms which are suitable for off-road use
- > Improves steering response
- > Zinc plate finish to increase corrosion resistance

With Grease Nipples

DA5501	DA5501M NEW	Series	4 track rod ends
DA5502	DA5502M NEW	Defender 90/110	3 track rod ends
DA5503	DA5503M NEW	Discovery 1/Range Rover Classic	3 track rod ends
DA5504	DA5504M NEW	Discovery 1	4 track rod ends
DA5509		Discovery 2	4 track rod ends
DA5541	Fixing kit for DA5503 & DA5504		
DA5527	Left hand replacement nut for DA5501/DA5502/DA5503/DA5504		
DA5528	Right hand replacement nut for DA5501/DA5502/DA5503/DA5504		

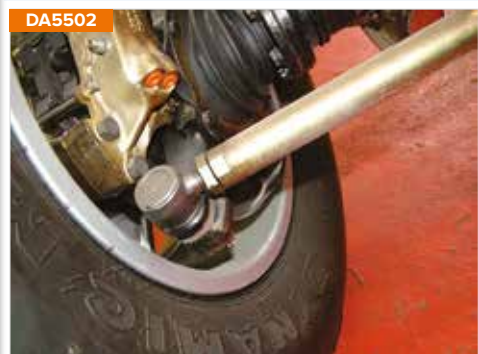

Track Rod End Replacements

4 track rod ends	2 x RTC5867 & 2 x RTC5868
3 track rod ends	2 x RTC5869 & 1 x RTC5870
3 track rod ends	2 x RTC5869 & 1 x RTC5870
4 track rod ends	2 x RTC5869 & 2 x RTC5870

Improves steering response



Shock Absorber & Suspension Kit Matrix

	Defender 90	Defender 110	Discovery 1	Discovery 2	Range Rover Classic	Range Rover P38	Series
Super Gaz Shock Absorbers							
Front							
Standard	DC5002	DC5002	DC5002	DC5000	DC5002		
50mm lift	DC5002L	DC5002L	DC5002L	DC5000L	DC5002L		
Rear							
Standard	DC5003	DC5003	DC5003	DC5001	DC5003		
50mm lift	DC5003L	DC5003L	DC5003L	DC5001L	DC5003L		
Steering damper							
Standard	DC5004	DC5004	DC5005		DC5005		DC5005
50mm lift	DC5004	DC5004	DC5005		DC5005		DC5005
Super Gaz Shock Absorber Suspension Kits							
Shock Absorber & Spring Kits							
Standard - heavy-duty kit	DA4284	DA4285	DA4284		DA4284		
25mm lift - light-duty kit	DA4301		DA4301		DA4301		
40mm lift - light-duty kit	DA4286		DA4286		DA4286		
40mm lift - medium-duty kit	DA4286MD		DA4286MD		DA4286MD		
40mm lift - heavy-duty kit	DA4286HD	DA4287	DA4286HD		DA4286HD		
40mm lift - no winch - kit				DA5008			
40mm lift - with winch - kit				DA5007			
Full Suspension Kits							
40mm lift - narrow bush - light-duty kit	DA4288				DA4288		
40mm lift - narrow bush - medium-duty kit	DA4288MD				DA4288MD		
40mm lift - narrow bush - heavy-duty kit	DA4288HD	DA4299			DA4288HD		
40mm lift - wide bush - light-duty kit	DA4289		DA4289		DA4289		
40mm lift - wide bush - medium-duty kit	DA4289MD		DA4289MD		DA4289MD		
40mm lift - wide bush - heavy-duty kit	DA4289HD	DA4300	DA4289HD		DA4289HD		
Cellular Dynamic Shock Absorbers							
Front							
Standard	DC6000	DC6000	DC6000	DC6010	DC6000	DC6002	
50mm lift	DC6000L	DC6000L	DC6000L		DC6000L		
Plus 5" shock absorber	DC6000LL	DC6000LL	DC6000LL		DC6000LL		
Rear							
Standard	DC6001	DC6001	DC6001	DC6011	DC6001	DC6003	
50mm lift	DC6001L	DC6001L	DC6001L		DC6001L		
Plus 5" shock absorber	DC6001LL	DC6001LL	DC6001LL		DC6001LL		
Steering damper							
Standard	DC6004	DC6004	DC6005	DC6009	DC6005	DC6006	DC6005
50mm lift	DC6004	DC6004	DC6005		DC6005		
Plus 5" shock absorber	DC6004	DC6004	DC6005		DC6005		
Cellular Dynamic Shock Absorber Suspension Kits							
Shock Absorber & Spring Kits							
Standard height - heavy-duty kit	DA4284C	DA4285C	DA4284C		DA4284C		
25mm lift - light-duty kit	DA4301C		DA4301C		DA4301C		
40mm lift - light-duty kit	DA4286C		DA4286C		DA4286C		
40mm lift - medium-duty kit	DA4286CMD		DA4286CMD		DA4286CMD		
40mm lift - heavy-duty kit	DA4286CHD	DA4287C	DA4286CHD		DA4286CHD		
Plus 5" shock absorber - light-duty kit	DA4363		DA4363		DA4363		
Plus 5" shock absorber - heavy-duty kit		DA4364					
Full Suspension Kits							
40mm lift - narrow bush - light-duty kit	DA4288C				DA4288C		
40mm lift - narrow bush - medium-duty kit	DA4288CMD				DA4288CMD		
40mm lift - narrow bush - heavy-duty kit	DA4288CHD	DA4299C			DA4288CHD		
Plus 5" shock - narrow bush - medium-duty kit	DA4365				DA4365		
Plus 5" shock - narrow bush - heavy-duty kit		DA4367					
40mm lift - wide bush - light-duty kit	DA4289C		DA4289C		DA4289C		
40mm lift - wide bush - medium-duty kit	DA4289CMD		DA4289CMD		DA4289CMD		
40mm lift - wide bush - heavy-duty kit	DA4289CHD	DA4300C	DA4289CHD		DA4289CHD		
Plus 5" shock absorber - wide bush - medium-duty kit	DA4366		DA4366		DA4366		
Plus 5" shock absorber - wide bush - heavy-duty kit		DA4368					

Diagnostics

Finding and rectifying common electrical faults in your Land Rover has never been easier with the Lynx Evo diagnostics tool from Britpart.

Calibration Tools	160
iCarsoft Multi-system Scanner	160
Lynx Evo Diagnostics Interface	146 - 159
Lynx Replacement Parts	160

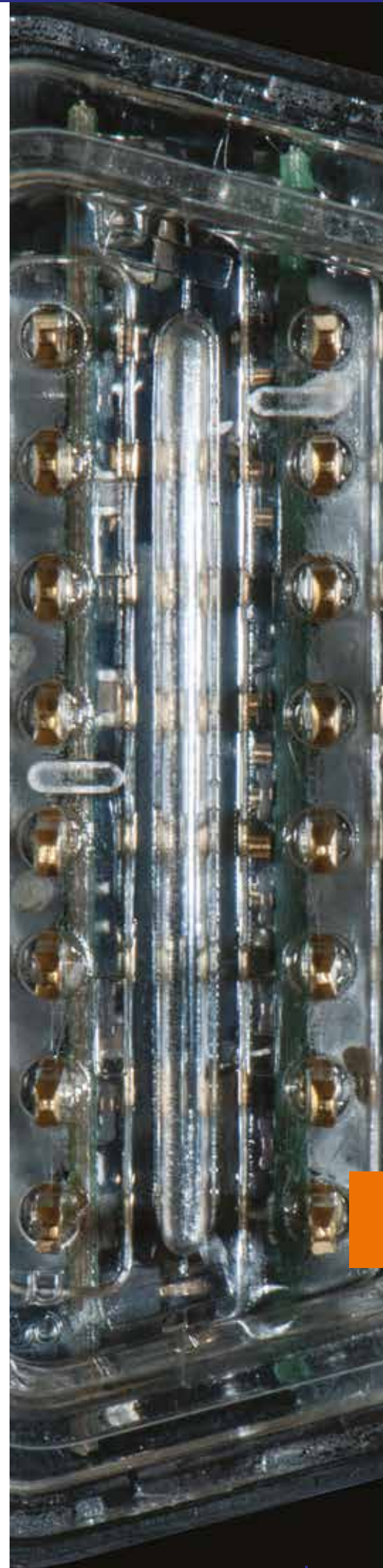

Lynx Evo Diagnostics Interface **NEW**

What is Lynx Evo?

Lynx Evo is the next generation diagnostic tool for Land Rover vehicles. Offering market leading diagnostics from a powerful and mobile design. Lynx Evo provides full vehicle servicing and in depth diagnostic capability for all Land Rover models from 1990 through to current day. Ideal for the workshop and home user.

Live data can also be displayed using numerics and graphics making it easier to read time based events on your Land Rover. This small but powerful Dongle requires no batteries as it uses the vehicles power. For the enthusiast home user, using Lynx Evo will mean no more trips to your local main dealer to clear any faults on your Land Rover.

Lynx Evo is compatible with iOS and Android mobile devices with apps available for download from the Apple App Store and Android Play Store. As the software is App Store based and is loaded onto your mobile device, updates are as easy to do as any other mobile app, simply click the update icon. Lynx Evo is manufactured by the company who supply Land Rover with their T4H Legacy diagnostic product.

What does Lynx Evo do?

- > Read fault codes
- > Clear fault codes
- > Read & display live data
- > Test actuators
- > Special functions - see coverage chart
- > Programming - such as alarm settings, key fobs etc. on selected models
- > Service reset

What do you get with Lynx Evo?

- > Lynx Evo dongle
- > Quick start guide
- > Protective carry case

What Land Rover models does Lynx Evo cover?

It is important to note that if you purchase an unlock code for a Discovery this code will cover all the Discovery family - from Discovery 1 through to Discovery 4. This feature is hugely beneficial if, at a later date, you upgrade your vehicle within the same Land Rover family you don't have to purchase another unlock code.

Defender Family

- > Defender - from 1990

Discovery Family

- > Discovery 1
- > Discovery 2
- > Discovery 3
- > Discovery 4

Freelander Family

- > Freelander 1
- > Freelander 2

Discovery Sport Family

- > Discovery Sport

Range Rover Family

- > Range Rover Classic
- > Range Rover P38
- > Range Rover L322
- > Range Rover L405

Range Rover Evoque Family

- > Range Rover Evoque

Range Rover Sport Family

- > Range Rover Sport - Mk1
- > Range Rover Sport - Mk2

Supported Languages

- > English
- > French
- > Spanish
- > Portuguese
- > German
- > Italian
- > Dutch

Upgrade software over app store



What do I need?

DA1500 NEW

Single Lynx Evo Land Rover family home user version. Unlocked for one Land Rover family only. Upgradable for extra Land Rover families at a later date.

Extras

DA1502 NEW

Unlock code for additional models.

DA1504 NEW

Range Rover Classic - cable kit for 14CUX, air suspension and ABS.

DA1505 NEW

Range Rover P38 - cable kit including air suspension, BECM.

Lynx Evo FAQ's available online



Example screen shots showing some of the different Lynx Evo display modes.



Key Features

- > Read & display live data
- > Mobile device based
- > Easy to use
- > Unlocked ready to cover an entire Land Rover model family
- > Upgrade software over app store
- > Quickly checks your Land Rover for faults
- > Small enough to store in glove box



Ideal for the workshop & home user

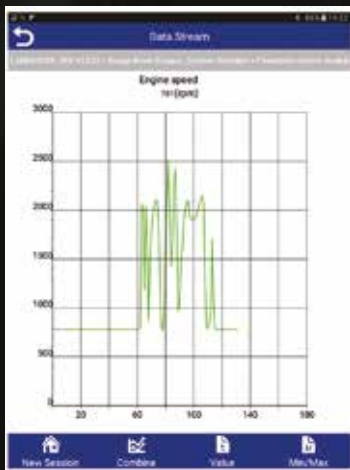
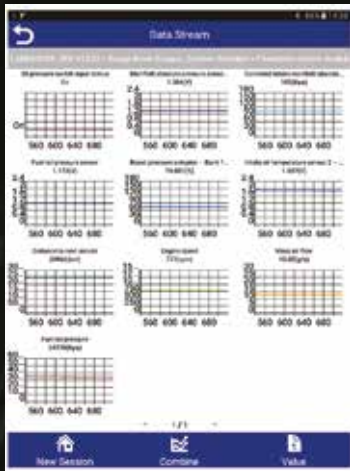

www.lynx-diagnostics.com

The Small Print

'Made for iPod', 'Made for iPhone' & 'Made for iPad' mean that an electronic accessory has been designed to connect specifically to iPod, iPhone or iPad respectively and has been certified by the developer to meet Apple performance standards. Apple is not responsible for the operation of this device or its compliance with safety and regulatory standards. Please note that the use of this accessory with iPod, iPhone or iPad may affect wireless performance. iPod, iPhone & iPad are trademarks of Apple Inc., registered in the U.S. and other countries.

Lynx Evo Vehicle Coverage

Vehicle Model	Years	System	System Name	Read Fault Codes	Clear Fault Codes	Live Data	ECM Data	Actuators	Special Functions
Defender	1999-2007	Diesel EMS	TD5	●	●	●		●	●
Defender	1994-2007	Petrol EMS	14CUX	●	●	●		●	●
Defender	1994-1995	Petrol EMS	GEMS	●	●	●		●	●
Defender	1999-2007	ABS	WABCO D ABS	●	●	●	●	●	●
Defender	1996-2007	Security	10AS					●	●
Defender	2007-2010	Drive - Diesel EMS	Diesel Engine Management System	●	●	●	●		●
Defender	2007-2010	Chassis - ABS	WABCO D ABS	●	●	●	●	●	●
Defender	2007-2010	Body - Instruments	IPC - Instrument Panel Control Module	●	●	●	●		●
Defender	2007-2010	Body - Security	10AS					●	●
Defender	2011	Drive - Diesel EMS	Diesel Engine Management System	●	●	●	●		●
Defender	2011	Chassis - ABS	ABS	●	●	●	●		●
Defender	2011	Body - Instruments	IPC - Instrument Panel Control Module	●	●	●	●		●
Defender	2011	Body - Security	10AS					●	●
Defender	2012-2016	Drive - Diesel EMS	PCM - Powertrain Control Module (Diesel)	●	●	●	●		●
Defender	2012-2016	Chassis - ABS	ABS	●	●	●	●		●
Defender	2012-2016	Body - Instruments	IPC - Instrument Panel Control Module	●	●	●	●		●
Defender	2012-2016	Body - Security	Vehicle immobilizer control module	●	●	●	●		●
Freelander 1	1998-2001	EMS - Diesel EMS	Bosch EDC 1.3.1	●	●	●	●	●	
Freelander 1	2001-2006	EMS - Diesel EMS	Bosch DDE4	●	●	●	●	●	●
Freelander 1	1998-2001	EMS - Petrol EMS	MEMS 1.9	●	●	●	●	●	●
Freelander 1	2001-2006	EMS - Petrol EMS	MEMS 3	●	●	●	●	●	●
Freelander 1	2001-2006	EMS - Petrol EMS	Siemens EMS2000	●	●	●	●	●	●
Freelander 1	2001-2006	EMS - Petrol EMS	Siemens MS43	●	●	●	●	●	●
Freelander 1	1998-2006	Transmission	Jatco	●	●	●	●	●	●
Freelander 1	1998-2001	ABS	WABCO D ABS	●	●	●	●	●	●
Freelander 1	2000-2001	ABS	TEVES MK20	●	●	●	●		●
Freelander 1	2002-2006	ABS	TEVES MK25	●	●	●	●		●
Freelander 1	1998-2002	Airbag	Autoliv ACU 4	●	●		●		●
Freelander 1	2003-2006	Airbag	Siemens SRE Smart	●	●		●		●
Freelander 1	1998-2001	Security	27VT - CCU			●		●	●
Freelander 1	2000-2002	Security	EWS 3D	●	●	●	●	●	●
Freelander 1	2000-2002	FFH	Fuel Fired Heater	●	●	●		●	●
Freelander 2	2007-2010	Drive - Diesel EMS	PCM - Power Train Control Module (Diesel)	●	●	●	●		●
Freelander 2	2007-2010	Drive - Petrol EMS	PCM - Power Train Control Module (Petrol)	●	●	●	●		●
Freelander 2	2007-2010	Drive - Transmission	TCM - Transmission Control Module	●	●	●	●		●
Freelander 2	2007-2010	Drive - Transmission	RDCM - Rear Differential Control Module	●	●	●	●		●
Freelander 2	2007-2010	Chassis - ABS/DSC	ABS / DSC - Anti-locking brake System / Dynamic Stability Control	●	●	●	●		●
Freelander 2	2007-2010	Chassis - Steering Angle	SASM - Steering Angle Sensor Module	●	●	●	●		●
Freelander 2	2007-2010	Chassis - ATCM	ATCM - All Terrain Control Module	●	●	●	●		●
Freelander 2	2007-2010	Body - Airbag	RCM - Restraints Control Module	●	●	●	●		●
Freelander 2	2007-2010	Body - Airbag	OCS - Occupancy Classification System	●	●	●	●		●
Freelander 2	2007-2010	Body - Climate Control	HVAC - Heating, Ventilation and Air Conditioning	●	●	●	●		●
Freelander 2	2007-2010	Body - Body Controller	BCM - Body Control Module	●	●	●	●		●
Freelander 2	2007-2010	Body - Instruments	IPC - Instrument Panel Control Module	●	●	●	●		●
Freelander 2	2007-2010	Body - Lighting Control	HCM - Headlamp Control Module	●	●	●	●		●
Freelander 2	2007-2010	Body - Parking Aid	PAM - Parking Aid Module	●	●	●	●		●
Freelander 2	2007-2010	Body - Fuel Fired Heater	FFH - Fuel Fired Heater	●	●	●	●		●
Freelander 2	2007-2010	Body - Seating	DSM - Drivers Seat Module	●	●	●	●		●
Freelander 2	2007-2010	Body - Doors	DDM - Drivers Door Module	●	●	●	●		●
Freelander 2	2007-2010	Body - Doors	PDM - Passengers Door Module	●	●	●	●		●
Freelander 2	2007-2010	Body - Trailer Module	TRM - Trailer Module	●	●	●	●		●
Freelander 2	2007-2010	Infotainment - ICM	ICM - Infotainment Control Module	●	●	●	●		●
Freelander 2	2007-2010	Infotainment	Satellite audio unit module	●	●	●	●		●
Freelander 2	2007-2010	Infotainment	Audio amplifier module	●	●	●	●		●
Freelander 2	2007-2010	Infotainment	Front control display interface module (high level display front)	●	●	●	●		●
Freelander 2	2007-2010	Infotainment	Audio front control module	●	●	●	●		●
Freelander 2	2007-2010	Infotainment	Cellular telephone control module (bluetooth telephone module)	●	●	●	●		●
Freelander 2	2011-2012	Drive - Diesel EMS	PCM - Power Train Control Module (Diesel)	●	●	●	●		●
Freelander 2	2011-2012	Drive - Petrol EMS	PCM - Power Train Control Module (Petrol)	●	●	●	●		●
Freelander 2	2011-2012	Drive - Transmission	TCM - Transmission Control Module	●	●	●	●		●
Freelander 2	2011-2012	Drive - Transmission	RDCM - Rear Differential Control Module	●	●	●	●		●
Freelander 2	2011-2012	Chassis - ABS/DSC	ABS / DSC - Anti-locking brake System / Dynamic Stability Control	●	●	●	●		●
Freelander 2	2011-2012	Chassis - Steering Angle	SASM - Steering Angle Sensor Module	●	●	●	●		●
Freelander 2	2011-2012	Chassis - ATCM	ATCM - All Terrain Control Module	●	●	●	●		●
Freelander 2	2011-2012	Body - Airbag	RCM - Restraints Control Module	●	●	●	●		●
Freelander 2	2011-2012	Body - Airbag	OCS - Occupancy Classification System	●	●	●	●		●
Freelander 2	2011-2012	Body - Climate Control	HVAC - Heating, Ventilation and Air Conditioning	●	●	●	●		●
Freelander 2	2011-2012	Body - Body Controller	BCM - Body Control Module	●	●	●	●		●
Freelander 2	2011-2012	Body - Instruments	IPC - Instrument Panel Control Module	●	●	●	●		●
Freelander 2	2011-2012	Body - Lighting Control	HCM - Headlamp Control Module	●	●	●	●		●
Freelander 2	2011-2012	Body - Parking Aid	PAM - Parking Aid Module	●	●	●	●		●
Freelander 2	2011-2012	Body - Fuel Fired Heater	FFH - Fuel Fired Heater	●	●	●	●		●
Freelander 2	2011-2012	Body - Seating	DSM - Drivers Seat Module	●	●	●	●		●
Freelander 2	2011-2012	Body - Doors	DDM - Drivers Door Module	●	●	●	●		●
Freelander 2	2011-2012	Body - Doors	PDM - Passengers Door Module	●	●	●	●		●
Freelander 2	2011-2012	Body - Trailer Module	TRM - Trailer Module	●	●	●	●		●
Freelander 2	2011-2012	Infotainment	ICM - Infotainment Control Module	●	●	●	●		●

Lynx Evo Vehicle Coverage - continued

Vehicle Model	Years	System	System Name	Read Fault Codes	Clear Fault Codes	Live Data	ECM Data	Actuators	Special Functions
Freelander 2	2011-2012	Infotainment	Audio amplifier module	●	●	●	●		
Freelander 2	2011-2012	Infotainment	Audio front control module	●	●	●	●		
Freelander 2	2011-2012	Infotainment	Cellular telephone control module	●	●	●	●		
Freelander 2	2011-2012	Infotainment	Digital audio broadcast module	●	●	●	●		
Freelander 2	2011-2012	Infotainment	Digital audio control module C	●	●	●	●		
Freelander 2	2011-2012	Infotainment	Front control/display interface module	●	●	●	●		
Freelander 2	2011-2012	Infotainment	Satellite audio unit module	●	●	●	●		
Freelander 2	2011-2012	Navigation	Navigation control module	●	●	●	●		
Freelander 2	2013-2014	Drive - Diesel EMS	PCM - Power Train Control Module (Diesel)	●	●	●	●		●
Freelander 2	2013-2014	Drive - Petrol EMS	PCM - Power Train Control Module (Petrol)	●	●	●	●		●
Freelander 2	2013-2014	Drive - Transmission	TCM - Transmission Control Module	●	●	●	●		●
Freelander 2	2013-2014	Drive - Transmission	RDCM - Rear Differential Control Module	●	●	●	●		
Freelander 2	2013-2014	Chassis - ABS/DSC	ABS / DSC - Anti-locking brake System / Dynamic Stability Control	●	●	●	●		●
Freelander 2	2013-2014	Chassis - Park Brake	PBM - Park Brake Module	●	●	●	●		●
Freelander 2	2013-2014	Chassis - Steering Angle	SASM - Steering Angle Sensor Module	●	●	●	●		●
Freelander 2	2013-2014	Chassis - ATCM	ATCM - All Terrain Control Module	●	●	●	●		
Freelander 2	2013-2014	Body - Airbag	RCM - Restraints Control Module	●	●	●	●		●
Freelander 2	2013-2014	Body - Security	Vehicle Immobiliser Control Module	●	●	●	●		
Freelander 2	2013-2014	Body - Security	Keyless Vehicle Module	●	●	●	●		
Freelander 2	2013-2014	Body - Climate Control	HVAC - Heating, Ventilation and Air Conditioning	●	●	●	●		●
Freelander 2	2013-2014	Body - Body Controller	BCM - Body Control Module	●	●	●	●		●
Freelander 2	2013-2014	Body - Instruments	IPC - Instrument Panel Control Module	●	●	●	●		●
Freelander 2	2013-2014	Body - Lighting Control	HCM - Headlamp Control Module	●	●	●	●		●
Freelander 2	2013-2014	Body - Parking Aid	PAM - Parking Aid Module	●	●	●	●		
Freelander 2	2013-2014	Body - Fuel Fired Heater	FFH - Fuel Fired Heater	●	●	●	●		●
Freelander 2	2013-2014	Body - Seating	DSM - Drivers Seat Module	●	●	●	●		●
Freelander 2	2013-2014	Body - Doors	DDM - Drivers Door Module	●	●	●	●		●
Freelander 2	2013-2014	Body - Doors	PDM - Passengers Door Module	●	●	●	●		●
Freelander 2	2013-2014	Infotainment	Front control/display interface module (high level display front)	●	●	●	●		
Freelander 2	2013-2014	Infotainment	Front controls interface module 'B' (front audio control panel)	●	●	●	●		
Freelander 2	2013-2014	Infotainment	Audio head unit	●	●	●	●		
Freelander 2	2013-2014	Infotainment	Image processing module B	●	●	●	●		
Freelander 2	2013-2014	Infotainment	Audio amplifier module	●	●	●	●		●
Freelander 2	2013-2014	Infotainment	Audio front control module	●	●	●	●		●
Freelander 2	2013-2014	Infotainment	Digital audio broadcast module	●	●	●	●		
Freelander 2	2013-2014	Infotainment	Satellite audio unit module	●	●	●	●		
Freelander 2	2013-2014	Infotainment	Television module	●	●	●	●		
Discovery 1	1996 - 1998	EMS - Diesel EMS	Bosch EDC 1.3.1	●	●	●	●		●
Discovery 1	1995 - 1998	EMS - Petrol EMS	14CUX	●	●	●	●		●
Discovery 1	1996 - 1998	EMS - Petrol EMS	GEMS	●	●	●	●		●
Discovery 1	1993 - 1998	EMS - Petrol EMS	MEMS 1.9	●	●	●	●		●
Discovery 1	1995 - 1996	ABS	WABCO C ABS	●	●	●	●		●
Discovery 1	1995 - 1996	Airbag	TRW MPS	●	●				
Discovery 1	1996 - 1998	Airbag	TRW SPS	●	●		●		
Discovery 1	1996 - 1998	Security	10AS			●			●
Discovery 2	1998 - 2005	Diesel EMS	TD5	●	●	●	●		●
Discovery 2	1998 - 2005	Petrol EMS	Bosch M5.2.1	●	●	●	●		●
Discovery 2	1998 - 2005	Transmission	GS 8.87X	●	●	●	●		●
Discovery 2	1998 - 2005	ABS	WABCO D ABS/SLABS	●	●	●	●		●
Discovery 2	1998 - 2005	Airbag	TRW Generation 4	●	●		●		
Discovery 2	1998 - 2005	Security	Valeo BCU			●			●
Discovery 2	1998 - 2005	Chassis	ACE - Suspension (ROCK/ARC)	●	●	●	●		●
Discovery 2	1998 - 2005	Chassis	WABCO D ABS/SLABS - Suspension	●	●	●	●		●
Discovery 3	2005-2009	Drive - Diesel EMS	PCM - Power Train Control Module (Diesel)	●	●	●	●		●
Discovery 3	2005-2009	Drive - Petrol EMS	PCM - Power Train Control Module (Petrol)	●	●	●	●		●
Discovery 3	2005-2009	Drive - Transmission	TCM - Transmission Control Module	●	●	●	●		●
Discovery 3	2005-2009	Drive - Transmission	RDCM - Rear Differential Control Module	●	●	●	●		
Discovery 3	2005-2009	Drive - Transfer Case	TCCM - Transfer Case Control Module	●	●	●	●		●
Discovery 3	2005-2009	Drive - Adaptive Cruise Control	CCM - Cruise Control Module	●	●	●	●		
Discovery 3	2005-2009	Chassis - ABS / DSC	ABS / DSC - Anti-locking brake System / Dynamic Stability Control	●	●	●	●		●
Discovery 3	2005-2009	Chassis - Steering Angle	SASM - Steering Angle Sensor Module	●	●	●	●		●
Discovery 3	2005-2009	Chassis - Park Brake	PBM - Park Brake Module	●	●	●	●		●
Discovery 3	2005-2009	Chassis - TPMS	TPMS - Tyre Pressure Monitoring System	●	●	●	●		●
Discovery 3	2005-2009	Chassis - ATCM	ATCM - All Terrain Control Module	●	●	●	●		
Discovery 3	2005-2009	Chassis - Suspension	RLM - Ride Level Control Module	●	●	●	●		●
Discovery 3	2005-2009	Body - Airbag	RCM - Restraints Control Module	●	●	●	●		●
Discovery 3	2005-2009	Body - Climate Control	HVAC - Heating Ventilation Air Conditioning Control Module	●	●	●	●		
Discovery 3	2005-2009	Body - Body Control	BCM - Body Control Module	●	●	●	●		●
Discovery 3	2005-2009	Body - Instruments	IPC - Instrument Panel Control Module	●	●	●	●		●
Discovery 3	2005-2009	Body - Lighting Control	FLM - Front Lighting Module	●	●	●	●		
Discovery 3	2005-2009	Body - Parking Aid	PAM - Parking Aid Module	●	●	●	●		
Discovery 3	2005-2009	Body - Fuel Fired Heater	FFH - Fuel Fired Heater	●	●	●	●		●
Discovery 3	2005-2009	Infotainment - Audio and Visual	AAM - Audio Amplifier Module	●	●	●	●		
Discovery 3	2005-2009	Infotainment - Audio and Visual	ACM - Audio Control Module	●	●	●	●		
Discovery 3	2005-2009	Infotainment - Audio and Visual	FEM - Front Electronic Module	●	●	●	●		
Discovery 3	2005-2009	Infotainment - Audio and Visual	DACMC - Digital Audio Control Module '91C'92	●	●	●	●		
Discovery 3	2005-2009	Infotainment - Audio and Visual	SRM - Satellite Audio Unit Module	●	●	●	●		
Discovery 3	2005-2009	Infotainment - Audio and Visual	TVM - Television Module	●	●	●	●		
Discovery 3	2005-2009	Infotainment - REM	REM - Rear Entertainment Control Module	●	●	●	●		
Discovery 3	2005-2009	Infotainment - TEL	TEL - Cellular Telephone Control Module	●	●	●	●		
Discovery 3	2005-2009	Infotainment - TMC	TMC - Traffic Message Channel Module	●	●	●	●		

Lynx Evo Vehicle Coverage - continued

Vehicle Model	Years	System	System Name	Read Fault Codes	Clear Fault Codes	Live Data	ECM Data	Actuators	Special Functions
Discovery 4	2010-2011	Drive - Diesel EMS	PCM - Power Train Control Module (Diesel V6 2.7)	●	●	●	●		●
Discovery 4	2010-2011	Drive - Diesel EMS	PCM - Power Train Control Module (Diesel V6 3.0)	●	●	●	●		●
Discovery 4	2010-2011	Drive - Petrol EMS	PCM - Power Train Control Module (Petrol V6)	●	●	●	●		●
Discovery 4	2010-2011	Drive - Petrol EMS	PCM - Power Train Control Module (Petrol V8)	●	●	●	●		●
Discovery 4	2010-2011	Drive - Transmission	TCM - Transmission Control Module (Diesel V6 2.7)	●	●	●	●		●
Discovery 4	2010-2011	Drive - Transmission	TCM - Transmission Control Module (Diesel V6 3.0)	●	●	●	●		●
Discovery 4	2010-2011	Drive - Transmission	TCM - Transmission Control Module (Petrol V6)	●	●	●	●		●
Discovery 4	2010-2011	Drive - Transmission	TCM - Transmission Control Module (Petrol V8)	●	●	●	●		●
Discovery 4	2010-2011	Drive - Transmission	GSM - Gear Shift Module	●	●	●	●		●
Discovery 4	2010-2011	Drive - Transmission	RDCM - Rear Differential Control Module	●	●	●	●		●
Discovery 4	2010-2011	Drive - Transfer Case	TCCM - Transfer Case Control Module	●	●	●	●		●
Discovery 4	2010-2011	Drive - Adaptive Cruise Control	CCM - Cruise Control Module	●	●	●	●		●
Discovery 4	2010-2011	Chassis - ABS / DSC	ABS / DSC - Anti-locking brake System / Dynamic Stability Control	●	●	●	●		●
Discovery 4	2010-2011	Chassis - Steering Angle	SASM - Steering Angle Sensor Module	●	●	●	●		●
Discovery 4	2010-2011	Chassis - Park Brake	PBM - Park Brake Module	●	●	●	●		●
Discovery 4	2010-2011	Chassis - ATCM	ATCM - All Terrain Control Module	●	●	●	●		●
Discovery 4	2010-2011	Chassis - Suspension	RLM - Ride Level Control Module	●	●	●	●		●
Discovery 4	2010-2011	Body - Airbag	RCM - Restraints Control Module	●	●	●	●		●
Discovery 4	2010-2011	Body - Airbag	OCS - Occupancy Classification System	●	●	●	●		●
Discovery 4	2010-2011	Body - Climate Control	HVAC - Heating Ventilation Air Conditioning Control Module	●	●	●	●		●
Discovery 4	2010-2011	Body - Body Controller	BCM - Body Control Module	●	●	●	●		●
Discovery 4	2010-2011	Body - Instruments	IPC - Instrument Panel Control Module	●	●	●	●		●
Discovery 4	2010-2011	Body - Lighting Control	HCM - Headlamp Control Module	●	●	●	●		●
Discovery 4	2010-2011	Body - Lighting Control	HCMB - Headlamp Control Module '91B'92	●	●	●	●		●
Discovery 4	2010-2011	Body - Parking Aid	PAM - Parking Aid Module	●	●	●	●		●
Discovery 4	2010-2011	Body - Immobiliser	Immobiliser	●	●	●	●		●
Discovery 4	2010-2011	Body - Fuel Fired Heater	FFH - Fuel Fired Heater	●	●	●	●		●
Discovery 4	2010-2011	Body - Seating	DSM - Drivers Seat Module	●	●	●	●		●
Discovery 4	2010-2011	Body - Doors	DDM - Drivers Door Module	●	●	●	●		●
Discovery 4	2010-2011	Body - Doors	PDM - Passengers Door Module	●	●	●	●		●
Discovery 4	2010-2011	Body - KVM	KVM - Keyless Vehicle Module	●	●	●	●		●
Discovery 4	2010-2011	Infotainment	AAM - Audio Amplifier Module	●	●	●	●		●
Discovery 4	2010-2011	Infotainment	ACM - Audio Control Module	●	●	●	●		●
Discovery 4	2010-2011	Infotainment	FEM - Front Electronic Module	●	●	●	●		●
Discovery 4	2010-2011	Infotainment	FCDIM - Front Control / Display Interface Module	●	●	●	●		●
Discovery 4	2010-2011	Infotainment	FCIM - Front Control Interface Module	●	●	●	●		●
Discovery 4	2010-2011	Infotainment	FCIMB - Front Control Interface Module '91B'92	●	●	●	●		●
Discovery 4	2010-2011	Infotainment	DABM - Digital Audio Broadcast Module	●	●	●	●		●
Discovery 4	2010-2011	Infotainment	DACMC - Digital Audio Control Module '91C'92	●	●	●	●		●
Discovery 4	2010-2011	Infotainment	SRM - Satellite Audio Unit Module	●	●	●	●		●
Discovery 4	2010-2011	Infotainment	TVM - Television Module	●	●	●	●		●
Discovery 4	2010-2011	Infotainment	REM - Rear Entertainment Control Module	●	●	●	●		●
Discovery 4	2010-2011	Infotainment	IPMB - Image Processing Module '91B'92	●	●	●	●		●
Discovery 4	2010-2011	Navigation	Navigation control module	●	●	●	●		●
Discovery 4	2012-2013	Drive - Diesel EMS	PCM - Power Train Control Module (Diesel V6 3.0)	●	●	●	●		●
Discovery 4	2012-2013	Drive - Petrol EMS	PCM - Power Train Control Module (Petrol)	●	●	●	●		●
Discovery 4	2012-2013	Drive - Transmission	TCM - Transmission Control Module (Diesel V6 3.0)	●	●	●	●		●
Discovery 4	2012-2013	Drive - Transmission	TCM - Transmission Control Module (Petrol)	●	●	●	●		●
Discovery 4	2012-2013	Drive - Transmission	GSM - Gear Shift Module	●	●	●	●		●
Discovery 4	2012-2013	Drive - Transmission	RDCM - Rear Differential Control Module	●	●	●	●		●
Discovery 4	2012-2013	Drive - Transfer Case	TCCM - Transfer Case Control Module	●	●	●	●		●
Discovery 4	2012-2013	Chassis - ABS / DSC	ABS / DSC - Anti-locking brake System / Dynamic Stability Control	●	●	●	●		●
Discovery 4	2012-2013	Chassis - Steering Angle	SASM - Steering Angle Sensor Module	●	●	●	●		●
Discovery 4	2012-2013	Chassis - Park Brake	PBM - Park Brake Module	●	●	●	●		●
Discovery 4	2012-2013	Chassis - ATCM	ATCM - All Terrain Control Module	●	●	●	●		●
Discovery 4	2012-2013	Chassis - Suspension	RLM - Ride Level Control Module	●	●	●	●		●
Discovery 4	2012-2013	Body - Airbag	RCM - Restraints Control Module	●	●	●	●		●
Discovery 4	2012-2013	Body - Airbag	OCS - Occupancy Classification System	●	●	●	●		●
Discovery 4	2012-2013	Body - Climate Control	HVAC - Heating Ventilation Air Conditioning Control Module	●	●	●	●		●
Discovery 4	2012-2013	Body - Body Controller	BCM - Body Control Module	●	●	●	●		●
Discovery 4	2012-2013	Body - Instruments	IPC - Instrument Panel Control Module	●	●	●	●		●
Discovery 4	2012-2013	Body - Lighting Control	HCM - Headlamp Control Module	●	●	●	●		●
Discovery 4	2012-2013	Body - Lighting Control	HCMB - Headlamp Control Module '91B'92	●	●	●	●		●
Discovery 4	2012-2013	Body - Parking Aid	PAM - Parking Aid Module	●	●	●	●		●
Discovery 4	2012-2013	Body - Immobiliser	Immobiliser	●	●	●	●		●
Discovery 4	2012-2013	Body - Fuel Fired Heater	FFH - Fuel Fired Heater	●	●	●	●		●
Discovery 4	2012-2013	Body - Doors	DDM - Drivers Door Module	●	●	●	●		●
Discovery 4	2012-2013	Body - Seating	Driver's seat module	●	●	●	●		●
Discovery 4	2012-2013	Body - Doors	PDM - Passengers Door Module	●	●	●	●		●
Discovery 4	2012-2013	Body - KVM	KVM - Keyless Vehicle Module	●	●	●	●		●
Discovery 4	2012-2013	Infotainment	FCDIM - Front Control / Display Interface Module	●	●	●	●		●
Discovery 4	2012-2013	Infotainment	FCIM - Front Control Interface Module	●	●	●	●		●
Discovery 4	2012-2013	Infotainment	FCIMB - Front Control Interface Module '91B'92	●	●	●	●		●
Discovery 4	2012-2013	Infotainment	IPMB - Image Processing Module '91B'92	●	●	●	●		●
Discovery 4	2012-2013	Infotainment	Audio head unit	●	●	●	●		●
Discovery 4	2012-2013	Infotainment	Television module	●	●	●	●		●
Discovery 4	2012-2013	Infotainment	Audio amplifier module	●	●	●	●		●
Discovery 4	2012-2013	Infotainment	Audio front control module	●	●	●	●		●
Discovery 4	2012-2013	Infotainment	Rear entertainment control module	●	●	●	●		●
Discovery 4	2012-2013	Navigation	Navigation control module	●	●	●	●		●

Lynx Evo Vehicle Coverage - continued

Vehicle Model	Years	System	System Name	Read Fault Codes	Clear Fault Codes	Live Data	ECM Data	Actuators	Special Functions
Discovery 4	2014-2015	Drive - Diesel EMS	PCM - Power Train Control Module (Diesel V6 3.0)	●	●	●	●		●
Discovery 4	2014-2015	Drive - Petrol EMS	PCM - Power Train Control Module (Petrol)	●	●	●	●		●
Discovery 4	2014-2015	Drive - Transmission	TCM - Transmission Control Module (Diesel V6 3.0)	●	●	●	●		●
Discovery 4	2014-2015	Drive - Transmission	TCM - Transmission Control Module (Petrol)	●	●	●	●		●
Discovery 4	2014-2015	Drive - Transmission	GSM - Gear Shift Module	●	●	●	●		●
Discovery 4	2014-2015	Drive - Transmission	RDCM - Rear Differential Control Module	●	●	●	●		●
Discovery 4	2014-2015	Drive - Transfer Case	TCCM - Transfer Case Control Module	●	●	●	●		●
Discovery 4	2014-2015	Chassis - ABS / DSC	ABS / DSC - Anti-locking brake System / Dynamic Stability Control	●	●	●	●		●
Discovery 4	2014-2015	Chassis - Steering Angle	SASM - Steering Angle Sensor Module	●	●	●	●		●
Discovery 4	2014-2015	Chassis - Park Brake	PBM - Park Brake Module	●	●	●	●		●
Discovery 4	2014-2015	Chassis - ATCM	ATCM - All Terrain Control Module	●	●	●	●		●
Discovery 4	2014-2015	Chassis - Suspension	RLM - Ride Level Control Module	●	●	●	●		●
Discovery 4	2014-2015	Body - Airbag	RCM - Restraints Control Module	●	●	●	●		●
Discovery 4	2014-2015	Body - Airbag	OCS - Occupancy Classification System	●	●	●	●		●
Discovery 4	2014-2015	Body - Climate Control	HVAC - Heating Ventilation Air Conditioning Control Module	●	●	●	●		●
Discovery 4	2014-2015	Body - Body Controller	BCM - Body Control Module	●	●	●	●		●
Discovery 4	2014-2015	Body - Instruments	IPC - Instrument Panel Control Module	●	●	●	●		●
Discovery 4	2014-2015	Body - Lighting Control	HCM - Headlamp Control Module	●	●	●	●		●
Discovery 4	2014-2015	Body - Lighting Control	HCMB - Headlamp Control Module '91B'92	●	●	●	●		●
Discovery 4	2014-2015	Body - Parking Aid	PAM - Parking Aid Module	●	●	●	●		●
Discovery 4	2014-2015	Body - Object Proximity	General proximity sensor module	●	●	●	●		●
Discovery 4	2014-2015	Body - Side Object Detection	Side object detection control module - Left	●	●	●	●		●
Discovery 4	2014-2015	Body - Side Object Detection	Side object detection control module - Right	●	●	●	●		●
Discovery 4	2014-2015	Body - Immobiliser	Immobiliser	●	●	●	●		●
Discovery 4	2014-2015	Body - Fuel Fired Heater	FFH - Fuel Fired Heater	●	●	●	●		●
Discovery 4	2014-2015	Body - Drivers Seat	Driver's seat module	●	●	●	●		●
Discovery 4	2014-2015	Body - Doors	DDM - Drivers Door Module	●	●	●	●		●
Discovery 4	2014-2015	Body - Doors	PDM - Passengers Door Module	●	●	●	●		●
Discovery 4	2014-2015	Body - KVM	KVM - Keyless Vehicle Module	●	●	●	●		●
Discovery 4	2014-2015	Infotainment - Audio and Visual	FCDIM - Front Control / Display Interface Module	●	●	●	●		●
Discovery 4	2014-2015	Infotainment - Audio and Visual	FCIM - Front Control Interface Module	●	●	●	●		●
Discovery 4	2014-2015	Infotainment - Audio and Visual	FCIMB - Front Control Interface Module '91B'92	●	●	●	●		●
Discovery 4	2014-2015	Infotainment - IPMB	IPMB - Image Processing Module '91B'92	●	●	●	●		●
Discovery 4	2014-2015	Infotainment - Audio and Visual	Connect and view module	●	●	●	●		●
Discovery 4	2014-2015	Speed Control	Speed control module	●	●	●	●		●
Discovery 4	2014-2015	Vehicle Network	Gateway module	●	●	●	●		●
Discovery Sport	2015-2016	Drive - Diesel EMS	PCM - Powertrain control module - Diesel	●	●	●	●		●
Discovery Sport	2015-2016	Drive - Petrol EMS	PCM - Powertrain control module - Petrol	●	●	●	●		●
Discovery Sport	2015-2016	Drive - Transmission	TCM - Transmission Control Module	●	●	●	●		●
Discovery Sport	2015-2016	Drive - Transmission	GSM - Gear Shift Module	●	●	●	●		●
Discovery Sport	2015-2016	Drive - Cruise Control	Speed Control Module	●	●	●	●		●
Discovery Sport	2015-2016	Chassis - ABS/DSC	ABS/DSC Control module	●	●	●	●		●
Discovery Sport	2015-2016	Chassis - Steering Angle	SASM - Steering Angle Sensor Module	●	●	●	●		●
Discovery Sport	2015-2016	Chassis - Power Steering	Power Steering Control Module	●	●	●	●		●
Discovery Sport	2015-2016	Chassis - Suspension	Adaptive damping control module	●	●	●	●		●
Discovery Sport	2015-2016	Chassis - All Wheel Drive	All wheel drive control module	●	●	●	●		●
Discovery Sport	2015-2016	Chassis - ATCM	All terrain control module	●	●	●	●		●
Discovery Sport	2015-2016	Chassis - TPMS	Tyre pressure monitor module	●	●	●	●		●
Discovery Sport	2015-2016	Body - Airbag	Restraints Module	●	●	●	●		●
Discovery Sport	2015-2016	Body - Airbag	Restraints occupant classification system module	●	●	●	●		●
Discovery Sport	2015-2016	Body - Climate Control	Heating ventilation and air conditioning control module	●	●	●	●		●
Discovery Sport	2015-2016	Body - Body Controller	Body control module	●	●	●	●		●
Discovery Sport	2015-2016	Body - Instruments	Instrument cluster control module	●	●	●	●		●
Discovery Sport	2015-2016	Body - Lighting Control	Headlamp control module	●	●	●	●		●
Discovery Sport	2015-2016	Body - Proximity	General proximity sensor module	●	●	●	●		●
Discovery Sport	2015-2016	Body - Parking Aid	Parking assist control module	●	●	●	●		●
Discovery Sport	2015-2016	Body - Object Detection	Side object detection control module - Left	●	●	●	●		●
Discovery Sport	2015-2016	Body - Object Detection	Side object detection control module - Right	●	●	●	●		●
Discovery Sport	2015-2016	Body - Immobiliser	Vehicle immobilizer control module	●	●	●	●		●
Discovery Sport	2015-2016	Body - Fuel-Fired Heater	Auxiliary heater control module	●	●	●	●		●
Discovery Sport	2015-2016	Body - Seating	Driver's seat module	●	●	●	●		●
Discovery Sport	2015-2016	Body - Seating	Passenger's seat module	●	●	●	●		●
Discovery Sport	2015-2016	Body - Doors	Driver's door module	●	●	●	●		●
Discovery Sport	2015-2016	Body - Doors	Passenger's door module	●	●	●	●		●
Discovery Sport	2015-2016	Body - Doors	Driver's (side) rear door module	●	●	●	●		●
Discovery Sport	2015-2016	Body - Doors	Passenger's (side) rear door module	●	●	●	●		●
Discovery Sport	2015-2016	Body - KVM	Keyless vehicle module	●	●	●	●		●
Discovery Sport	2015-2016	Body - RGTM	Rear gate / trunk module	●	●	●	●		●
Discovery Sport	2015-2016	Infotainment	Head-up display cooling fan module	●	●	●	●		●
Discovery Sport	2015-2016	Infotainment	Connect and view module	●	●	●	●		●
Discovery Sport	2015-2016	Infotainment	Front control/display interface module (high level display front)	●	●	●	●		●
Discovery Sport	2015-2016	Infotainment	Head up display	●	●	●	●		●
Discovery Sport	2015-2016	Infotainment	InControl Touch audio head unit	●	●	●	●		●
Discovery Sport	2015-2016	Infotainment	Image processing module B	●	●	●	●		●
Discovery Sport	2015-2016	Infotainment	Audio amplifier module	●	●	●	●		●
Discovery Sport	2015-2016	Infotainment	Audio front control module	●	●	●	●		●
Discovery Sport	2015-2016	Infotainment	Digital audio broadcast module	●	●	●	●		●
Discovery Sport	2015-2016	Infotainment	Rear entertainment control module	●	●	●	●		●
Discovery Sport	2015-2016	Infotainment	Satellite audio unit module	●	●	●	●		●
Discovery Sport	2015-2016	Infotainment	Image processing control module A	●	●	●	●		●
Discovery Sport	2015-2016	Infotainment	Television module	●	●	●	●		●
Discovery Sport	2015-2016	Navigation	Navigation control module	●	●	●	●		●
Discovery Sport	2015-2016	Telematics	Telematic control unit module	●	●	●	●		●
Discovery Sport	2015-2016	Vehicle Network	Gateway module	●	●	●	●		●
Discovery Sport	2015-2016	Towbar	Deployable tow bar control module	●	●	●	●		●

Lynx Evo Vehicle Coverage - continued

Vehicle Model	Years	System	System Name	Read Fault Codes	Clear Fault Codes	Live Data	ECM Data	Actuators	Special Functions
Range Rover Classic	1990 - 1995	Petrol EMS		●	●	●			
Range Rover Classic	1990 - 1995	Petrol EMS		●	●	●			
Range Rover Classic	1990 - 1995	Petrol EMS		●	●	●			
Range Rover Classic	1990 - 1995	Petrol EMS		●	●	●			
Range Rover P38	1995 - 2002	Diesel EMS	Bosch EDC 1.3.1	●	●	●	●	●	●
Range Rover P38	1999 - 2002	Petrol EMS	Bosch M5.21	●	●	●	●	●	●
Range Rover P38	1995 - 1999	Petrol EMS	GEMS	●	●	●	●	●	●
Range Rover P38	1998-2002	Transmission	GS 2.38	●	●	●	●	●	●
Range Rover P38	1995-1999	Transmission	GS 8.87X	●	●	●	●	●	●
Range Rover P38	1998-2002	ABS	WABCO C ABS	●	●	●	●	●	●
Range Rover P38	1995-1999	ABS	WABCO D ABS	●	●	●	●	●	●
Range Rover P38	1999-2002	Airbag	TRW MPS	●	●	●	●	●	●
Range Rover P38	1995-2002	Airbag	TRW SPS	●	●	●	●	●	●
Range Rover P38	1995-1999	Airbag	TRW Gen 4	●	●	●	●	●	●
Range Rover P38	1995-2002	Climate Control	HVAC - Heating Ventilation Air Conditioning Control Module	●	●	●	●	●	●
Range Rover P38	1998-2002	Chassis	Air Suspension	●	●	●	●	●	●
Range Rover P38	1998-2002	Body Electrics	BeCM	●	●	●	●	●	●
Range Rover L322	2002-2005	Drive - Diesel EMS	Bosch DDE4	●	●	●	●	●	●
Range Rover L322	2002-2005	Drive - Petrol EMS	Bosch ME7.2	●	●	●	●	●	●
Range Rover L322	2002-2005	Drive - Transmission	GM5 / EGS 20	●	●	●	●	●	●
Range Rover L322	2002-2005	Drive - Transmission	ZF / EGS 8602	●	●	●	●	●	●
Range Rover L322	2002-2005	Chassis - ABS / DSC	Bosch 5.7	●	●	●	●	●	●
Range Rover L322	2002-2005	Chassis - Steering Angle	Steering Angle	●	●	●	●	●	●
Range Rover L322	2002-2005	Chassis - Air Suspension	EHC2	●	●	●	●	●	●
Range Rover L322	2002-2005	Body - Airbag	MRS 4	●	●	●	●	●	●
Range Rover L322	2002-2005	Body - Climate Control	HVAC - Heating Ventilation Air Conditioning Control Module	●	●	●	●	●	●
Range Rover L322	2002-2005	Body - Body Electrics	GM3	●	●	●	●	●	●
Range Rover L322	2002-2005	Body - Security	EWS3	●	●	●	●	●	●
Range Rover L322	2002-2005	Body - Fuel Fired Heater	Fuel Fired Heater	●	●	●	●	●	●
Range Rover L322	2002-2005	Infotainment - Audio and Video	AAM - Audio Amplifier Module	●	●	●	●	●	●
Range Rover L322	2002-2005	Infotainment - Audio and Video	ACM - Audio Control Module	●	●	●	●	●	●
Range Rover L322	2002-2005	Infotainment - Audio and Video	FEM - Front Electronic Module	●	●	●	●	●	●
Range Rover L322	2002-2005	Infotainment - Audio and Video	CDP - Compact Disc Player	●	●	●	●	●	●
Range Rover L322	2002-2005	Infotainment - Audio and Video	SRM - Satellite Audio Unit Module	●	●	●	●	●	●
Range Rover L322	2002-2005	Infotainment - Audio and Video	TVM - Television Module	●	●	●	●	●	●
Range Rover L322	2002-2005	Infotainment - REM	REM - Rear Entertainment Control Module	●	●	●	●	●	●
Range Rover L322	2002-2005	Infotainment - TEL	TEL - Cellular Telephone Control Module	●	●	●	●	●	●
Range Rover L322	2002-2005	Infotainment - TMC	TMC - Traffic Message Channel Module	●	●	●	●	●	●
Range Rover L322	2006	Drive - Diesel EMS	PCM - Diesel EMS	●	●	●	●	●	●
Range Rover L322	2006	Drive - Petrol EMS	Drive - Petrol EMS	●	●	●	●	●	●
Range Rover L322	2006	Drive - Transmission (Diesel)	Drive - Transmission (Diesel)	●	●	●	●	●	●
Range Rover L322	2006	Drive - Transmission (Petrol)	TCM - Transmission Control Module	●	●	●	●	●	●
Range Rover L322	2006	Drive - Transmission	TCCM - Transfer Case Control Module	●	●	●	●	●	●
Range Rover L322	2006	Chassis - All Terrain	All terrain control module	●	●	●	●	●	●
Range Rover L322	2006	Chassis - ABS (Diesel)	Bosch 5.7	●	●	●	●	●	●
Range Rover L322	2006	Chassis - ABS (Petrol)	Bosch 8	●	●	●	●	●	●
Range Rover L322	2006	Chassis - Park Brake	Parking brake control module	●	●	●	●	●	●
Range Rover L322	2006	Chassis - Steering Angle (Petrol)	SASM - Steering Angle Sensor Module	●	●	●	●	●	●
Range Rover L322	2006	Chassis - TPMS	TPMS - Tyre Pressure Monitoring System	●	●	●	●	●	●
Range Rover L322	2006	Chassis - Air Suspension	RLM - Ride Level Control Module	●	●	●	●	●	●
Range Rover L322	2006	Body - Airbag	MRS 4	●	●	●	●	●	●
Range Rover L322	2006	Body - Occupant Restraints	Restraints occupant classification system module	●	●	●	●	●	●
Range Rover L322	2006	Body - Drivers Seat	Driver's seat module	●	●	●	●	●	●
Range Rover L322	2006	Body - Climate Control	HVAC - Heating Ventilation Air Conditioning Control Module	●	●	●	●	●	●
Range Rover L322	2006	Body - Body Electrics	GM3	●	●	●	●	●	●
Range Rover L322	2006	Body - Security	Steering Lock Module	●	●	●	●	●	●
Range Rover L322	2006	Body - Wash Wipe	Rain Sensor	●	●	●	●	●	●
Range Rover L322	2006	Body - Parking Aid	Parking aid control module	●	●	●	●	●	●
Range Rover L322	2006	Body Running Boards	Running board control module	●	●	●	●	●	●
Range Rover L322	2006	Body - Instruments	IPC - Instrument Panel Control Module	●	●	●	●	●	●
Range Rover L322	2006	Body - Lighting Control	FLM - Front Lighting Module	●	●	●	●	●	●
Range Rover L322	2006	Body - Security	Body Controller	●	●	●	●	●	●
Range Rover L322	2006	Body - Immobilizer	Vehicle immobilizer control module	●	●	●	●	●	●
Range Rover L322	2006	Body - Fuel Fired Heater	Fuel Fired Heater	●	●	●	●	●	●
Range Rover L322	2006	Infotainment - Audio and Video	AAM - Audio Amplifier Module	●	●	●	●	●	●
Range Rover L322	2006	Infotainment - Audio and Video	ACM - Audio Control Module	●	●	●	●	●	●
Range Rover L322	2006	Infotainment - Audio and Video	FEM - Front Electronic Module	●	●	●	●	●	●
Range Rover L322	2006	Infotainment - Audio and Video	SRM - Satellite Audio Unit Module	●	●	●	●	●	●
Range Rover L322	2006	Infotainment - Audio and Video	TVM - Television Module	●	●	●	●	●	●
Range Rover L322	2006	Infotainment - REM	REM - Rear Entertainment Control Module	●	●	●	●	●	●
Range Rover L322	2006	Infotainment - TEL	TEL - Cellular Telephone Control Module	●	●	●	●	●	●
Range Rover L322	2006	Infotainment - TMC	TMC - Traffic Message Channel Module	●	●	●	●	●	●
Range Rover L322	2007-2009	Drive - Diesel EMS	PCM - Power Train Control Module (Diesel)	●	●	●	●	●	●
Range Rover L322	2007-2009	Drive - Petrol EMS	PCM - Power Train Control Module (Petrol)	●	●	●	●	●	●
Range Rover L322	2007-2009	Drive - Transmission	TCM - Transmission Control Module	●	●	●	●	●	●
Range Rover L322	2007-2009	Drive - Transmission	RDCM - Rear Differential Control Module	●	●	●	●	●	●
Range Rover L322	2007-2009	Drive - Transfer Case	TCCM - Transfer Case Control Module	●	●	●	●	●	●
Range Rover L322	2007-2009	Chassis - ABS / DSC	ABS / DSC - Anti-locking brake System / Dynamic Stability Control	●	●	●	●	●	●
Range Rover L322	2007-2009	Chassis - Steering Angle	SASM - Steering Angle Sensor Module	●	●	●	●	●	●
Range Rover L322	2007-2009	Chassis - Parking Brake	PBM - Park Brake Module	●	●	●	●	●	●
Range Rover L322	2007-2009	Chassis - TPMS	TPMS - Tyre Pressure Monitoring System	●	●	●	●	●	●

Lynx Evo Vehicle Coverage - continued

Vehicle Model	Years	System	System Name	Read Fault Codes	Clear Fault Codes	Live Data	ECM Data	Actuators	Special Functions
Range Rover L322	2007-2009	Chassis - ATCM	ATCM - All Terrain Control Module	●	●	●	●		
Range Rover L322	2007-2009	Chassis - Suspension	RLM - Ride Level Control Module	●	●	●	●		●
Range Rover L322	2007-2009	Body - Parking Aid	Parking aid control module	●	●	●	●		
Range Rover L322	2007-2009	Body - Airbag	RCM - Restraints Control Module	●	●	●	●		●
Range Rover L322	2007-2009	Body - Airbag	OCS - Occupancy Classification System	●	●	●	●		●
Range Rover L322	2007-2009	Body - Climate Control	HVAC - Heating Ventilation Air Conditioning Control Module	●	●	●	●		●
Range Rover L322	2007-2009	Body - Climate Control	RHVAC - Rear Heating Ventilation Air Conditioning Control Module	●	●	●	●		
Range Rover L322	2007-2009	Body - Body Electrics	GM3	●	●	●	●		●
Range Rover L322	2007-2009	Body - Instruments	IPC - Instrument Panel Control Module	●	●	●	●		●
Range Rover L322	2007-2009	Body - Lighting Control	FLM - Front Lighting Module	●	●	●	●		
Range Rover L322	2007-2009	Body - Security	Immobiliser	●	●	●	●		
Range Rover L322	2007-2009	Body - Security	Steering Lock Module	●	●	●	●		
Range Rover L322	2007-2009	Body - Fuel Fired Heater	FFH - Fuel Fired Heater	●	●	●	●		●
Range Rover L322	2007-2009	Body - Seating	DCSM - Drivers Climate Seat Module	●	●	●	●		
Range Rover L322	2007-2009	Body - Seating	Driver's seat module	●	●	●	●		
Range Rover L322	2007-2009	Body - Seating	RBM - Running Board Control Module	●	●	●	●		●
Range Rover L322	2007-2009	Body - RDUM	RDUM - Remote Driver Utility Module	●	●	●	●		
Range Rover L322	2007-2009	Infotainment - Audio and Video	AAM - Audio Amplifier Module	●	●	●	●		
Range Rover L322	2007-2009	Infotainment - Audio and Video	ACM - Audio Control Module	●	●	●	●		
Range Rover L322	2007-2009	Infotainment - Audio and Video	FEM - Front Electronic Module	●	●	●	●		
Range Rover L322	2007-2009	Infotainment - Audio and Video	CDP - Compact Disc Player	●	●	●	●		
Range Rover L322	2007-2009	Infotainment - Audio and Video	SRM - Satellite Audio Unit Module	●	●	●	●		
Range Rover L322	2007-2009	Infotainment - Audio and Video	TVM - Television Module	●	●	●	●		
Range Rover L322	2007-2009	Infotainment - REM	REM - Rear Entertainment Control Module	●	●	●	●		
Range Rover L322	2007-2009	Infotainment - TEL	TEL - Cellular Telephone Control Module	●	●	●	●		
Range Rover L322	2007-2009	Infotainment - TMC	TMC - Traffic Message Channel Module	●	●	●	●		
Range Rover L322	2010 - 2012	Diesel - V8 3.6 - Engine	PCM - Power Train Control Module (Diesel)	●	●	●	●		●
Range Rover L322	2010 - 2012	Diesel - V8 3.6 - Transmission	TCM - Transmission Control Module	●	●	●	●		●
Range Rover L322	2010 - 2012	Diesel - V8 3.6 - Transmission	RDCM - Rear Differential Control Module	●	●	●	●		
Range Rover L322	2010 - 2012	Diesel - V8 3.6 - Transfer Case	TCCM - Transfer Case Control Module	●	●	●	●		●
Range Rover L322	2010 - 2012	Diesel - V8 3.6 - Adaptive Cruise Control	CCM - Cruise Control Module	●	●	●	●		
Range Rover L322	2010 - 2012	Diesel - V8 4.4 - Engine	PCM - Power Train Control Module (Diesel)	●	●	●	●		●
Range Rover L322	2010 - 2012	Diesel - V8 4.4 - Transmission	TCM - Transmission Control Module	●	●	●	●		●
Range Rover L322	2010 - 2012	Diesel - V8 4.4 - Transmission	GSM - Gear Shift Module	●	●	●	●		
Range Rover L322	2010 - 2012	Diesel - V8 4.4 - Transmission	RDCM - Rear Differential Control Module	●	●	●	●		
Range Rover L322	2010 - 2012	Diesel - V8 4.4 - Transfer Case	TCCM - Transfer Case Control Module	●	●	●	●		●
Range Rover L322	2010 - 2012	Diesel - V8 4.4 - Adaptive Cruise Control	CCM - Cruise Control Module	●	●	●	●		
Range Rover L322	2010 - 2012	Petrol - Engine	PCM - Power Train Control Module (Petrol)	●	●	●	●		●
Range Rover L322	2010 - 2012	Petrol - Transmission	TCM - Transmission Control Module	●	●	●	●		●
Range Rover L322	2010 - 2012	Petrol - Transmission	RDCM - Rear Differential Control Module	●	●	●	●		
Range Rover L322	2010 - 2012	Petrol - Transfer Case	TCCM - Transfer Case Control Module	●	●	●	●		●
Range Rover L322	2010 - 2012	Petrol - Adaptive Cruise Control	CCM - Cruise Control Module	●	●	●	●		
Range Rover L322	2010 - 2012	Chassis - ABS / DSC	ABS / DSC - Anti-locking brake System / Dynamic Stability Control	●	●	●	●		●
Range Rover L322	2010 - 2012	Chassis - Steering Angle	SASM - Steering Angle Sensor Module	●	●	●	●		●
Range Rover L322	2010 - 2012	Chassis - Parking Brake	PBM - Park Brake Module	●	●	●	●		●
Range Rover L322	2010 - 2012	Chassis - TPMS	TPMS - Tyre Pressure Monitoring System	●	●	●	●		●
Range Rover L322	2010 - 2012	Chassis - Suspension	RLM - Ride Level Control Module	●	●	●	●		●
Range Rover L322	2010 - 2012	Chassis - Suspension	ADCM - Adaptive Damping Control Module	●	●	●	●		
Range Rover L322	2010 - 2012	Chassis - Chassis	ATCM - All Terrain Control Module	●	●	●	●		
Range Rover L322	2010 - 2012	Body - Airbag	RCM - Restraints Control Module	●	●	●	●		●
Range Rover L322	2010 - 2012	Body - Airbag	OCS - Occupancy Classification System	●	●	●	●		●
Range Rover L322	2010 - 2012	Body - Climate Control	HVAC - Heating Ventilation Air Conditioning Control Module	●	●	●	●		●
Range Rover L322	2010 - 2012	Body - Climate Control	RHVAC - Rear Heating Ventilation Air Conditioning Control Module	●	●	●	●		
Range Rover L322	2010 - 2012	Body - Body Controller	BCM - Body Control Module	●	●	●	●		●
Range Rover L322	2010 - 2012	Body - Instruments	IPC - Instrument Panel Control Module	●	●	●	●		●
Range Rover L322	2010 - 2012	Body - Lighting Control	HCM - Headlamp Control Module	●	●	●	●		
Range Rover L322	2010 - 2012	Body - Lighting Control	HCM - Headlamp Control Module '91B'92	●	●	●	●		
Range Rover L322	2010 - 2012	Body - Parking Aid	PAM - Parking Aid Module	●	●	●	●		
Range Rover L322	2010 - 2012	Body - Object Detection	SODL - Side Object Detection Module Left	●	●	●	●		
Range Rover L322	2010 - 2012	Body - Object Detection	SODR - Side Object Detection Module Right	●	●	●	●		
Range Rover L322	2010 - 2012	Body - Immobiliser	Immobiliser	●	●	●	●		
Range Rover L322	2010 - 2012	Body - Seating	DSM - Drivers Seat Module	●	●	●	●		●
Range Rover L322	2010 - 2012	Body - Seating	PSM - Passengers Seat Module	●	●	●	●		
Range Rover L322	2010 - 2012	Body - Seating	DCSM - Drivers Climate Seat Module	●	●	●	●		
Range Rover L322	2010 - 2012	Body - Seating	RDCSM - Rear Climate Seat Module	●	●	●	●		
Range Rover L322	2010 - 2012	Body - Doors	DDM - Drivers Door Module	●	●	●	●		●
Range Rover L322	2010 - 2012	Body - Doors	PDM - Passengers Door Module	●	●	●	●		●
Range Rover L322	2010 - 2012	Body - KVM	KVM - Keyless Vehicle Module	●	●	●	●		
Range Rover L322	2010 - 2012	Body - RBM	RBM - Running Board Control Module	●	●	●	●		
Range Rover L322	2010 - 2012	Body - RDUM	RDUM - Remote Driver Utility Module	●	●	●	●		
Range Rover L322	2010 - 2012	Infotainment - Audio and Video	AAM - Audio Amplifier Module	●	●	●	●		
Range Rover L322	2010 - 2012	Infotainment - Audio and Video	ACM - Audio Control Module	●	●	●	●		
Range Rover L322	2010 - 2012	Infotainment - Audio and Video	FEM - Front Electronic Module	●	●	●	●		
Range Rover L322	2010 - 2012	Infotainment - Audio and Video	CDP - Compact Disc Player	●	●	●	●		
Range Rover L322	2010 - 2012	Infotainment - Audio and Video	DABM - Digital Audio Broadcast Module	●	●	●	●		
Range Rover L322	2010 - 2012	Infotainment - Audio and Video	DACMC - Digital Audio Control Module '91C'92	●	●	●	●		
Range Rover L322	2010 - 2012	Infotainment - Audio and Video	SRM - Satellite Audio Unit Module	●	●	●	●		
Range Rover L322	2010 - 2012	Infotainment - Audio and Video	TVM - Television Module	●	●	●	●		
Range Rover L322	2010 - 2012	Infotainment - REM	REM - Rear Entertainment Control Module	●	●	●	●		
Range Rover L322	2010 - 2012	Infotainment - TEL	TEL - Cellular Telephone Control Module	●	●	●	●		
Range Rover L322	2010 - 2012	Infotainment - IPMB	IPMB - Image Processing Module '91B'92	●	●	●	●		

Lynx Evo Vehicle Coverage - continued

Vehicle Model	Years	System	System Name	Read Fault Codes	Clear Fault Codes	Live Data	ECM Data	Actuators	Special Functions
Range Rover L322	2013	Diesel - Engine	PCM - Power Train Control Module (Diesel)	●	●	●	●		●
Range Rover L322	2013	Diesel - Transmission	TCM - Transmission Control Module	●	●	●	●		●
Range Rover L322	2013	Diesel - Transmission	GSM - Gear Shift Module	●	●	●	●		
Range Rover L322	2013	Diesel - Transmission	RDCM - Rear Differential Control Module	●	●	●	●		
Range Rover L322	2013	Diesel - Transfer Case	TCCM - Transfer Case Control Module	●	●	●	●		●
Range Rover L322	2013	Diesel - Adaptive Cruise Control	CCM - Cruise Control Module	●	●	●	●		
Range Rover L322	2013	Petrol - Engine	PCM - Power Train Control Module (Petrol)	●	●	●	●		●
Range Rover L322	2013	Petrol - Transmission	TCM - Transmission Control Module	●	●	●	●		●
Range Rover L322	2013	Petrol - Transmission	RDCM - Rear Differential Control Module	●	●	●	●		
Range Rover L322	2013	Petrol - Transfer Case	TCCM - Transfer Case Control Module	●	●	●	●		●
Range Rover L322	2013	Petrol - Adaptive Cruise Control	CCM - Cruise Control Module	●	●	●	●		
Range Rover L322	2013	Chassis - ABS / DSC	ABS / DSC - Anti-locking brake System / Dynamic Stability Control	●	●	●	●		●
Range Rover L322	2013	Chassis - Steering Angle	SASM - Steering Angle Sensor Module	●	●	●	●		●
Range Rover L322	2013	Chassis - Parking Brake	PBM - Park Brake Module	●	●	●	●		●
Range Rover L322	2013	Chassis - TPMS	TPMS - Tyre Pressure Monitoring System	●	●	●	●		●
Range Rover L322	2013	Chassis - Suspension	RLM - Ride Level Control Module	●	●	●	●		●
Range Rover L322	2013	Chassis - Chassis	ATCM - All Terrain Control Module	●	●	●	●		
Range Rover L322	2013	Chassis - Chassis Control	Chassis control module	●	●	●	●		
Range Rover L322	2013	Chassis - Chassis Control	Chassis control module B	●	●	●	●		
Range Rover L322	2013	Power Steering	Power steering control module	●	●	●	●		
Range Rover L322	2013	Body - Airbag	RCM - Restraints Control Module	●	●	●	●		●
Range Rover L322	2013	Body - Airbag	OCS - Occupancy Classification System	●	●	●	●		●
Range Rover L322	2013	Body - Pretensioners	Safety belt pre-tensioner control module A - drivers side	●	●	●	●		
Range Rover L322	2013	Body - Pretensioners	Safety belt pre-tensioner control module B - passengers side	●	●	●	●		
Range Rover L322	2013	Body - Climate Control	HVAC - Heating Ventilation Air Conditioning Control Module	●	●	●	●		●
Range Rover L322	2013	Body - Climate Control	RHVAC - Rear Heating Ventilation Air Conditioning Control Module	●	●	●	●		
Range Rover L322	2013	Body - Body Controller	BCM - Body Control Module	●	●	●	●		●
Range Rover L322	2013	Body - Instruments	IPC - Instrument Panel Control Module	●	●	●	●		●
Range Rover L322	2013	Body - Lighting Control	HCM - Headlamp Control Module	●	●	●	●		●
Range Rover L322	2013	Body - Lighting Control	HCMB - Headlamp Control Module '91B'92	●	●	●	●		
Range Rover L322	2013	Body - Parking Aid	PAM - Parking Aid Module	●	●	●	●		
Range Rover L322	2013	Body - Object Detection	SODL - Side Object Detection Module Left	●	●	●	●		
Range Rover L322	2013	Body - Object Detection	SODR - Side Object Detection Module Right	●	●	●	●		
Range Rover L322	2013	Body - Immobiliser	Immobiliser	●	●	●	●		
Range Rover L322	2013	Body - Seating	DSM - Drivers Seat Module	●	●	●	●		●
Range Rover L322	2013	Body - Seating	PSM - Passengers Seat Module	●	●	●	●		●
Range Rover L322	2013	Body - Seating	DCSM - Drivers Climate Seat Module	●	●	●	●		
Range Rover L322	2013	Body - Seating	RDCSM - Rear Climate Seat Module	●	●	●	●		
Range Rover L322	2013	Body - Seating	Rear left - Seat module	●	●	●	●		
Range Rover L322	2013	Body - Seating	Rear right - Seat module	●	●	●	●		
Range Rover L322	2013	Body - Doors	DDM - Drivers Door Module	●	●	●	●		●
Range Rover L322	2013	Body - Doors	PDM - Passengers Door Module	●	●	●	●		●
Range Rover L322	2013	Body - Doors	Rear gate/trunk module	●	●	●	●		
Range Rover L322	2013	Body - Doors	Lower - Rear gate/trunk module	●	●	●	●		●
Range Rover L322	2013	Body - KVM	KVM - Keyless Vehicle Module	●	●	●	●		●
Range Rover L322	2013	Body - RBM	RBM - Running Board Control Module	●	●	●	●		
Range Rover L322	2013	Body - RDUM	RDUM - Remote Driver Utility Module	●	●	●	●		
Range Rover L322	2013	Infotainment	AAM - Audio Amplifier Module	●	●	●	●		
Range Rover L322	2013	Infotainment	ACM - Audio Control Module	●	●	●	●		
Range Rover L322	2013	Infotainment	Front control/display interface module(high level display front)	●	●	●	●		
Range Rover L322	2013	Infotainment	Front controls interface module(heating ventilation air conditioning controls)	●	●	●	●		
Range Rover L322	2013	Infotainment	Front controls interface module 'B' (front audio control panel)	●	●	●	●		
Range Rover L322	2013	Infotainment	Front controls interface module 'C' (front audio control panel)	●	●	●	●		
Range Rover L322	2013	Infotainment - Audio and Video	DABM - Digital Audio Broadcast Module	●	●	●	●		
Range Rover L322	2013	Infotainment - Audio and Video	SRM - Satellite Audio Unit Module	●	●	●	●		
Range Rover L322	2013	Infotainment - Audio and Video	TVM - Television Module	●	●	●	●		
Range Rover L322	2013	Infotainment - REM	REM - Rear Entertainment Control Module	●	●	●	●		
Range Rover L322	2013	Infotainment - TEL	TEL - Cellular Telephone Control Module	●	●	●	●		
Range Rover L322	2013	Infotainment - IPMB	IPMB - Image Processing Module '91B'92	●	●	●	●		
Range Rover L322	2013	Vehicle Network	Gateway module	●	●	●	●		
Range Rover L405	2014-2015	Diesel - Engine	PCM - Power Train Control Module (Diesel)	●	●	●	●		●
Range Rover L405	2014-2015	Diesel - Transmission	TCM - Transmission Control Module	●	●	●	●		●
Range Rover L405	2014-2015	Diesel - Transmission	GSM - Gear Shift Module	●	●	●	●		
Range Rover L405	2014-2015	Diesel - Transmission	RDCM - Rear Differential Control Module	●	●	●	●		●
Range Rover L405	2014-2015	Diesel - Transfer Case	TCCM - Transfer Case Control Module	●	●	●	●		●
Range Rover L405	2014-2015	Diesel - Adaptive Cruise Control	CCM - Cruise Control Module	●	●	●	●		●
Range Rover L405	2014-2015	Petrol - Engine	PCM - Power Train Control Module (Petrol)	●	●	●	●		●
Range Rover L405	2014-2015	Petrol - Transmission	TCM - Transmission Control Module	●	●	●	●		●
Range Rover L405	2014-2015	Petrol - Transmission	RDCM - Rear Differential Control Module	●	●	●	●		●
Range Rover L405	2014-2015	Petrol - Transfer Case	TCCM - Transfer Case Control Module	●	●	●	●		●
Range Rover L405	2014-2015	Petrol - Adaptive Cruise Control	CCM - Cruise Control Module	●	●	●	●		●
Range Rover L405	2014-2015	Chassis - ABS / DSC	ABS / DSC - Anti-locking brake System / Dynamic Stability Control	●	●	●	●		●
Range Rover L405	2014-2015	Chassis - Steering Angle	SASM - Steering Angle Sensor Module	●	●	●	●		●
Range Rover L405	2014-2015	Chassis - Parking Brake	PBM - Park Brake Module	●	●	●	●		●
Range Rover L405	2014-2015	Chassis - TPMS	TPMS - Tyre Pressure Monitoring System	●	●	●	●		●
Range Rover L405	2014-2015	Chassis - Chassis	ATCM - All Terrain Control Module	●	●	●	●		
Range Rover L405	2014-2015	Chassis - Chassis Control	Chassis control module	●	●	●	●		
Range Rover L405	2014-2015	Chassis - Chassis Control	Chassis control module B	●	●	●	●		
Range Rover L405	2014-2015	Power Steering	Power steering control module	●	●	●	●		
Range Rover L405	2014-2015	Body - Airbag	RCM - Restraints Control Module	●	●	●	●		●
Range Rover L405	2014-2015	Body - Airbag	OCS - Occupancy Classification System	●	●	●	●		●
Range Rover L405	2014-2015	Body - Pretensioners	Safety belt pretensioner control module A - drivers side	●	●	●	●		
Range Rover L405	2014-2015	Body - Pretensioners	Safety belt pretensioner control module B - passengers side	●	●	●	●		
Range Rover L405	2014-2015	Body - Climate Control	HVAC - Heating Ventilation Air Conditioning Control Module	●	●	●	●		●
Range Rover L405	2014-2015	Body - Climate Control	RHVAC - Rear Heating Ventilation Air Conditioning Control Module	●	●	●	●		
Range Rover L405	2014-2015	Body - Body Controller	BCM - Body Control Module	●	●	●	●		●
Range Rover L405	2014-2015	Body - Instruments	IPC - Instrument Panel Control Module	●	●	●	●		●

Lynx Evo Vehicle Coverage - continued

Vehicle Model	Years	System	System Name	Read Fault Codes	Clear Fault Codes	Live Data	ECM Data	Actuators	Special Functions
Range Rover L405	2014-2015	Body - Lighting Control	HCM - Headlamp Control Module	●	●	●	●		●
Range Rover L405	2014-2015	Body - Lighting Control	HCMB - Headlamp Control Module '91B'92	●	●	●	●		
Range Rover L405	2014-2015	Body - Parking Aid	PAM - Parking Aid Module	●	●	●	●		
Range Rover L405	2014-2015	Body - Object Detection	SODL - Side Object Detection Module Left	●	●	●	●		
Range Rover L405	2014-2015	Body - Object Detection	SODR - Side Object Detection Module Right	●	●	●	●		
Range Rover L405	2014-2015	Body - Immobiliser	Immobiliser	●	●	●	●		
Range Rover L405	2014-2015	Body - Seating	DSM - Drivers Seat Module	●	●	●	●		●
Range Rover L405	2014-2015	Body - Seating	PSM - Passengers Sear Module	●	●	●	●		●
Range Rover L405	2014-2015	Body - Seating	DCSM - Drivers Climate Seat Module	●	●	●	●		
Range Rover L405	2014-2015	Body - Seating	RDCSM - Rear Climate Seat Module	●	●	●	●		
Range Rover L405	2014-2015	Body - Seating	Rear left - Seat module	●	●	●	●		
Range Rover L405	2014-2015	Body - Seating	Rear right - Seat module	●	●	●	●		
Range Rover L405	2014-2015	Body - Doors	DDM - Drivers Door Module	●	●	●	●		●
Range Rover L405	2014-2015	Body - Doors	PDM - Passengers Door Module	●	●	●	●		●
Range Rover L405	2014-2015	Body - Doors	Rear gate/trunk module	●	●	●	●		●
Range Rover L405	2014-2015	Body - Doors	Lower - Rear gate/trunk module	●	●	●	●		
Range Rover L405	2014-2015	Body - Table	Calf rest table module	●	●	●	●		
Range Rover L405	2014-2015	Body - Doors	KVM - Keyless Vehicle Module	●	●	●	●		●
Range Rover L405	2014-2015	Body - RBM	RBM - Running Board Control Module	●	●	●	●		●
Range Rover L405	2014-2015	Body - RDUM	RDUM - Remote Driver Utility Module	●	●	●	●		
Range Rover L405	2014-2015	Body - Proximity	General proximity sensor module	●	●	●	●		
Range Rover L405	2014-2015	Infotainment	AAM - Audio Amplifier Module	●	●	●	●		●
Range Rover L405	2014-2015	Infotainment	ACM - Audio Control Module	●	●	●	●		●
Range Rover L405	2014-2015	Infotainment	Head-up display cooling fan module	●	●	●	●		
Range Rover L405	2014-2015	Infotainment	Connect and view module	●	●	●	●		
Range Rover L405	2014-2015	Infotainment	Head up display	●	●	●	●		
Range Rover L405	2014-2015	Infotainment	Front control/display interface module (high level display front)	●	●	●	●		
Range Rover L405	2014-2015	Infotainment	Front controls interface module (heating ventilation air conditioning controls)	●	●	●	●		
Range Rover L405	2014-2015	Infotainment	Front controls interface module 'B' (front audio control panel)	●	●	●	●		
Range Rover L405	2014-2015	Infotainment	Front controls interface module 'C' (front audio control panel)	●	●	●	●		
Range Rover L405	2014-2015	Infotainment	DABM - Digital Audio Broadcast Module	●	●	●	●		
Range Rover L405	2014-2015	Infotainment	SRM - Satellite Audio Unit Module	●	●	●	●		
Range Rover L405	2014-2015	Infotainment	TVM - Television Module	●	●	●	●		
Range Rover L405	2014-2015	Infotainment	REM - Rear Entertainment Control Module	●	●	●	●		
Range Rover L405	2014-2015	Infotainment	TEL - Cellular Telephone Control Module	●	●	●	●		
Range Rover L405	2014-2015	Infotainment	IPMB - Image Processing Module '91B'92	●	●	●	●		
Range Rover L405	2014-2015	Navigation	Navigation control module	●	●	●	●		
Range Rover L405	2014-2015	Telematics	Telematic control unit module	●	●	●	●		
Range Rover L405	2014-2015	Battery	Battery energy control module	●	●	●	●		
Range Rover L405	2014-2015	Inverter	Electric power inverter converter module	●	●	●	●		
Range Rover L405	2014-2015	Vehicle Network	Gateway module	●	●	●	●		●
Range Rover Sport	2005-2009	Drive - Diesel EMS	PCM - Power Train Control Module (Diesel)	●	●	●	●	●	●
Range Rover Sport	2005-2009	Drive - Petrol EMS	PCM - Power Train Control Module (Petrol)	●	●	●	●	●	●
Range Rover Sport	2005-2009	Drive - Transmission	TCM - Transmission Control Module	●	●	●	●	●	●
Range Rover Sport	2005-2009	Drive - Transmission	RDCM - Rear Differential Control Module	●	●	●	●	●	●
Range Rover Sport	2005-2009	Drive - Transfer Case	TCCM - Transfer Case Control Module	●	●	●	●	●	●
Range Rover Sport	2005-2009	Drive - Adaptive Cruise Control	CCM - Cruise Control Module	●	●	●	●	●	●
Range Rover Sport	2005-2009	Chassis - ABS / DSC	ABS / DSC - Anti-locking brake System / Dynamic Stability Control	●	●	●	●	●	●
Range Rover Sport	2005-2009	Chassis - Steering Angle	SASM - Steering Angle Sensor Module	●	●	●	●	●	●
Range Rover Sport	2005-2009	Chassis - Parking Brake	PBM - Park Brake Module	●	●	●	●	●	●
Range Rover Sport	2005-2009	Chassis - TPMS	TPMS - Tyre Pressure Monitoring System	●	●	●	●	●	●
Range Rover Sport	2005-2009	Chassis - ARCM	ARCM - Dynamic Response Module	●	●	●	●	●	●
Range Rover Sport	2005-2009	Chassis - ATCM	ATCM - All Terrain Control Module	●	●	●	●	●	●
Range Rover Sport	2005-2009	Chassis - Suspension	RLM - Ride Level Control Module	●	●	●	●	●	●
Range Rover Sport	2005-2009	Body - Airbag	RCM - Restraints Control Module	●	●	●	●	●	●
Range Rover Sport	2005-2009	Body - Climate Control	HVAC - Heating Ventilation Air Conditioning Control Module	●	●	●	●	●	●
Range Rover Sport	2005-2009	Body - Body Controller	BCM - Body Control Module	●	●	●	●	●	●
Range Rover Sport	2005-2009	Body - Instruments	IPC - Instrument Panel Control Module	●	●	●	●	●	●
Range Rover Sport	2005-2009	Body - Lighting Control	FLM - Front Lighting Module	●	●	●	●	●	●
Range Rover Sport	2005-2009	Body - Parking Aid	PAM - Parking Aid Module	●	●	●	●	●	●
Range Rover Sport	2005-2009	Body - Fuel Fired Heater	FFH - Fuel Fired Heater	●	●	●	●	●	●
Range Rover Sport	2005-2009	Infotainment - Audio and Video	AAM - Audio Amplifier Module	●	●	●	●	●	●
Range Rover Sport	2005-2009	Infotainment - Audio and Video	ACM - Audio Control Module	●	●	●	●	●	●
Range Rover Sport	2005-2009	Infotainment - Audio and Video	FEM - Front Electronic Module	●	●	●	●	●	●
Range Rover Sport	2005-2009	Infotainment - Audio and Video	DACMC - Digital Audio Control Module '91C'92	●	●	●	●	●	●
Range Rover Sport	2005-2009	Infotainment - Audio and Video	SRM - Satellite Audio Unit Module	●	●	●	●	●	●
Range Rover Sport	2005-2009	Infotainment - REM	REM - Rear Entertainment Control Module	●	●	●	●	●	●
Range Rover Sport	2005-2009	Infotainment - TEL	TEL - Cellular Telephone Control Module	●	●	●	●	●	●
Range Rover Sport	2005-2009	Infotainment - TMC	TMC - Traffic Message Channel Module	●	●	●	●	●	●
Range Rover Sport	2010-2011	Drive - Diesel EMS	PCM - Power Train Control Module (Diesel V6)	●	●	●	●	●	●
Range Rover Sport	2010-2011	Drive - Diesel EMS	PCM - Power Train Control Module (Diesel V8)	●	●	●	●	●	●
Range Rover Sport	2010-2011	Drive - Petrol EMS	PCM - Power Train Control Module (Petrol)	●	●	●	●	●	●
Range Rover Sport	2010-2011	Drive - Transmission	TCM - Transmission Control Module (Diesel V6)	●	●	●	●	●	●
Range Rover Sport	2010-2011	Drive - Transmission	TCM - Transmission Control Module (Diesel V8)	●	●	●	●	●	●
Range Rover Sport	2010-2011	Drive - Transmission	TCM - Transmission Control Module (Petrol)	●	●	●	●	●	●
Range Rover Sport	2010-2011	Drive - Transmission	RDCM - Rear Differential Control Module	●	●	●	●	●	●
Range Rover Sport	2010-2011	Drive - Transfer Case	TCCM - Transfer Case Control Module	●	●	●	●	●	●
Range Rover Sport	2010-2011	Chassis - ABS / DSC	ABS / DSC - Anti-locking brake System / Dynamic Stability Control	●	●	●	●	●	●
Range Rover Sport	2010-2011	Chassis - Steering Angle	SASM - Steering Angle Sensor Module	●	●	●	●	●	●
Range Rover Sport	2010-2011	Chassis - Parking Brake	PBM - Park Brake Module	●	●	●	●	●	●
Range Rover Sport	2010-2011	Chassis - TPMS	TPMS - Tyre Pressure Monitoring System	●	●	●	●	●	●
Range Rover Sport	2010-2011	Chassis - ARCM	ARCM - Dynamic Response Module	●	●	●	●	●	●
Range Rover Sport	2010-2011	Chassis - ATCM	ATCM - All Terrain Control Module	●	●	●	●	●	●
Range Rover Sport	2010-2011	Chassis - Suspension	RLM - Ride Level Control Module	●	●	●	●	●	●
Range Rover Sport	2010-2011	Chassis - Suspension	ADCM - Adaptive Damping Control Module	●	●	●	●	●	●

Lynx Evo Vehicle Coverage - continued

Vehicle Model	Years	System	System Name	Read Fault Codes	Clear Fault Codes	Live Data	ECM Data	Actuators	Special Functions
Range Rover Sport	2010-2011	Body - Airbag	RCM - Restraints Control Module	●	●	●	●		●
Range Rover Sport	2010-2011	Body - Airbag	OCS - Occupancy Classification System	●	●	●	●		●
Range Rover Sport	2010-2011	Body - Climate Control	HVAC - Heating Ventilation Air Conditioning Control Module	●	●	●	●		●
Range Rover Sport	2010-2011	Body - Body Controller	BCM - Body Control Module	●	●	●	●		●
Range Rover Sport	2010-2011	Body - Instruments	IPC - Instrument Panel Control Module	●	●	●	●		●
Range Rover Sport	2010-2011	Body - Lighting Control	HCM - Headlamp Control Module	●	●	●	●		●
Range Rover Sport	2010-2011	Body - Lighting Control	HCMB - Headlamp Control Module '91B'92	●	●	●	●		●
Range Rover Sport	2010-2011	Body - Parking Aid	PAM - Parking Aid Module	●	●	●	●		●
Range Rover Sport	2010-2011	Body - Immobiliser	Immobiliser	●	●	●	●		●
Range Rover Sport	2010-2011	Body - Seating	DSM - Drivers Seat Module	●	●	●	●		●
Range Rover Sport	2010-2011	Body - Doors	DDM - Drivers Door Module	●	●	●	●		●
Range Rover Sport	2010-2011	Body - Doors	PDM - Passengers Door Module	●	●	●	●		●
Range Rover Sport	2010-2011	Body - KVM	KVM - Keyless Vehicle Module	●	●	●	●		●
Range Rover Sport	2010-2011	Infotainment - Audio and Video	AAM - Audio Amplifier Module	●	●	●	●		●
Range Rover Sport	2010-2011	Infotainment - Audio and Video	ACM - Audio Control Module	●	●	●	●		●
Range Rover Sport	2010-2011	Infotainment - Audio and Video	FEM - Front Electronic Module	●	●	●	●		●
Range Rover Sport	2010-2011	Infotainment - Audio and Video	FCIM - Front Control Interface Module	●	●	●	●		●
Range Rover Sport	2010-2011	Infotainment - Audio and Video	FCIMB - Front Control Interface Module '91B'92	●	●	●	●		●
Range Rover Sport	2010-2011	Infotainment - Audio and Video	TVM - Television Module	●	●	●	●		●
Range Rover Sport	2010-2011	Infotainment - REM	REM - Rear Entertainment Control Module	●	●	●	●		●
Range Rover Sport	2010-2011	Infotainment - TEL	TEL - Cellular Telephone Control Module	●	●	●	●		●
Range Rover Sport	2010-2011	Infotainment - IPMB	IPMB - Image Processing Module '91B'92	●	●	●	●		●
Range Rover Sport	2012 - 2013	Drive - Diesel EMS	PCM - Power Train Control Module (Diesel)	●	●	●	●		●
Range Rover Sport	2012 - 2013	Drive - Petrol EMS	PCM - Power Train Control Module (Petrol)	●	●	●	●		●
Range Rover Sport	2012 - 2013	Drive - Transmission	TCM - Transmission Control Module (Diesel V6)	●	●	●	●		●
Range Rover Sport	2012 - 2013	Drive - Transmission	TCM - Transmission Control Module (Diesel V8)	●	●	●	●		●
Range Rover Sport	2012 - 2013	Drive - Transmission	TCM - Transmission Control Module (Petrol)	●	●	●	●		●
Range Rover Sport	2012 - 2013	Drive - Transmission	GSM - Gear Shift Module	●	●	●	●		●
Range Rover Sport	2012 - 2013	Drive - Transmission	RDCM - Rear Differential Control Module	●	●	●	●		●
Range Rover Sport	2012 - 2013	Drive - Transfer Case	TCCM - Transfer Case Control Module	●	●	●	●		●
Range Rover Sport	2012 - 2013	Drive - Adaptive Cruise Control	CCM - Cruise Control Module	●	●	●	●		●
Range Rover Sport	2012 - 2013	Chassis - ABS / DSC	ABS / DSC - Anti-locking brake System / Dynamic Stability Control	●	●	●	●		●
Range Rover Sport	2012 - 2013	Chassis - Steering Angle	SASM - Steering Angle Sensor Module	●	●	●	●		●
Range Rover Sport	2012 - 2013	Chassis - Parking Brake	PBM - Park Brake Module	●	●	●	●		●
Range Rover Sport	2012 - 2013	Chassis - TPMS	TPMS - Tyre Pressure Monitoring System	●	●	●	●		●
Range Rover Sport	2012 - 2013	Chassis - ARCM	ARCM - Dynamic Response Module	●	●	●	●		●
Range Rover Sport	2012 - 2013	Chassis - ATCM	ATCM - All Terrain Control Module	●	●	●	●		●
Range Rover Sport	2012 - 2013	Chassis - Suspension	RLM - Ride Level Control Module	●	●	●	●		●
Range Rover Sport	2012 - 2013	Chassis - Suspension	ADCM - Adaptive Damping Control Module	●	●	●	●		●
Range Rover Sport	2012 - 2013	Body - Airbag	RCM - Restraints Control Module	●	●	●	●		●
Range Rover Sport	2012 - 2013	Body - Airbag	OCS - Occupancy Classification System	●	●	●	●		●
Range Rover Sport	2012 - 2013	Body - Climate Control	HVAC - Heating Ventilation Air Conditioning Control Module	●	●	●	●		●
Range Rover Sport	2012 - 2013	Body - Body Controller	BCM - Body Control Module	●	●	●	●		●
Range Rover Sport	2012 - 2013	Body - Instruments	IPC - Instrument Panel Control Module	●	●	●	●		●
Range Rover Sport	2012 - 2013	Body - Lighting Control	HCM - Headlamp Control Module	●	●	●	●		●
Range Rover Sport	2012 - 2013	Body - Lighting Control	HCMB - Headlamp Control Module '91B'92	●	●	●	●		●
Range Rover Sport	2012 - 2013	Body - Parking Aid	PAM - Parking Aid Module	●	●	●	●		●
Range Rover Sport	2012 - 2013	Body - Immobiliser	Immobiliser	●	●	●	●		●
Range Rover Sport	2012 - 2013	Body - Fuel Fired Heater	FFH - Fuel Fired Heater	●	●	●	●		●
Range Rover Sport	2012 - 2013	Body - Seating	DSM - Drivers Seat Module	●	●	●	●		●
Range Rover Sport	2012 - 2013	Body - Doors	DDM - Drivers Door Module	●	●	●	●		●
Range Rover Sport	2012 - 2013	Body - Doors	PDM - Passengers Door Module	●	●	●	●		●
Range Rover Sport	2012 - 2013	Body - KVM	KVM - Keyless Vehicle Module	●	●	●	●		●
Range Rover Sport	2012 - 2013	Body - RGTM	RGTM - Rear Gate/Trunk Module	●	●	●	●		●
Range Rover Sport	2012 - 2013	Infotainment	FCDIM - Front Control/Display Interface Module	●	●	●	●		●
Range Rover Sport	2012 - 2013	Infotainment	FCIM - Front Control Interface Module	●	●	●	●		●
Range Rover Sport	2012 - 2013	Infotainment	FCIMB - Front Control Interface Module '91B'92	●	●	●	●		●
Range Rover Sport	2012 - 2013	Infotainment	IPMB - Image Processing Module '91B'92	●	●	●	●		●
Range Rover Sport	2012 - 2013	Infotainment	Audio front control module	●	●	●	●		●
Range Rover Sport	2012 - 2013	Infotainment	Digital audio broadcast module	●	●	●	●		●
Range Rover Sport	2012 - 2013	Infotainment	Rear entertainment control module	●	●	●	●		●
Range Rover Sport	2012 - 2013	Infotainment	Satellite audio unit module	●	●	●	●		●
Range Rover Sport	2012 - 2013	Infotainment	Television module	●	●	●	●		●
Range Rover Sport	2012 - 2013	Infotainment	Audio amplifier module	●	●	●	●		●
Range Rover Sport	2012 - 2013	Infotainment	Accessory protocol interface module	●	●	●	●		●
Range Rover Sport	2012 - 2013	Navigation	Navigation control module	●	●	●	●		●
Range Rover Sport	2014-2015	Drive - Diesel EMS	PCM - Power Train Control Module (Diesel)	●	●	●	●		●
Range Rover Sport	2014-2015	Drive - Petrol EMS	PCM - Power Train Control Module (Petrol)	●	●	●	●		●
Range Rover Sport	2014-2015	Drive - Transmission	TCM - Transmission Control Module (Diesel V6)	●	●	●	●		●
Range Rover Sport	2014-2015	Drive - Transmission	TCM - Transmission Control Module (Diesel V8)	●	●	●	●		●
Range Rover Sport	2014-2015	Drive - Transmission	TCM - Transmission Control Module (Petrol)	●	●	●	●		●
Range Rover Sport	2014-2015	Drive - Transmission	GSM - Gear Shift Module	●	●	●	●		●
Range Rover Sport	2014-2015	Drive - Transmission	RDCM - Rear Differential Control Module	●	●	●	●		●
Range Rover Sport	2014-2015	Drive - Transfer Case	TCCM - Transfer Case Control Module	●	●	●	●		●
Range Rover Sport	2014-2015	Drive - Adaptive Cruise Control	CCM - Cruise Control Module	●	●	●	●		●
Range Rover Sport	2014-2015	Chassis - ABS / DSC	ABS / DSC - Anti-locking brake System / Dynamic Stability Control	●	●	●	●		●
Range Rover Sport	2014-2015	Chassis - Steering Angle	SASM - Steering Angle Sensor Module	●	●	●	●		●
Range Rover Sport	2014-2015	Chassis - Parking Brake	PBM - Park Brake Module	●	●	●	●		●
Range Rover Sport	2014-2015	Chassis - TPMS	TPMS - Tyre Pressure Monitoring System	●	●	●	●		●
Range Rover Sport	2014-2015	Chassis - ATCM	ATCM - All Terrain Control Module	●	●	●	●		●
Range Rover Sport	2014-2015	Chassis - Suspension	Chassis control module	●	●	●	●		●
Range Rover Sport	2014-2015	Chassis - Suspension	Chassis control module B	●	●	●	●		●
Range Rover Sport	2014-2015	Power Steering	Power steering control module	●	●	●	●		●
Range Rover Sport	2014-2015	Body - Airbag	RCM - Restraints Control Module	●	●	●	●		●
Range Rover Sport	2014-2015	Body - Airbag	OCS - Occupancy Classification System	●	●	●	●		●

Lynx Evo Vehicle Coverage - continued

Vehicle Model	Years	System	System Name	Read Fault Codes	Clear Fault Codes	Live Data	ECM Data	Actuators	Special Functions
Range Rover Sport	2014-2015	Body - Restraints	Safety belt pre-tensioner control module A - drivers side	●	●	●	●		
Range Rover Sport	2014-2015	Body - Restraints	Safety belt pre-tensioner control module B - passengers side	●	●	●	●		
Range Rover Sport	2014-2015	Body - Climate Control	HVAC - Heating Ventilation Air Conditioning Control Module	●	●	●	●		●
Range Rover Sport	2014-2015	Rear HVAC	Rear Heating ventilation and air conditioning control module	●	●	●	●		
Range Rover Sport	2014-2015	Body - Body Controller	BCM - Body Control Module	●	●	●	●		●
Range Rover Sport	2014-2015	Body - Instruments	IPC - Instrument Panel Control Module	●	●	●	●		●
Range Rover Sport	2014-2015	Body - Lighting Control	HCM - Headlamp Control Module	●	●	●	●		
Range Rover Sport	2014-2015	Body - Lighting Control	HCMB - Headlamp Control Module '91B'92	●	●	●	●		
Range Rover Sport	2014-2015	Body - Parking Aid	PAM - Parking Aid Module	●	●	●	●		●
Range Rover Sport	2014-2015	Body - Immobiliser	Immobiliser	●	●	●	●		
Range Rover Sport	2014-2015	Body - Seating	DSM - Drivers Seat Module	●	●	●	●		●
Range Rover Sport	2014-2015	Body - Doors	DDM - Drivers Door Module	●	●	●	●		●
Range Rover Sport	2014-2015	Body - Seating	Passenger Seat Module	●	●	●	●		●
Range Rover Sport	2014-2015	Body - Seating	Rear left - Seat module	●	●	●	●		
Range Rover Sport	2014-2015	Body - Seating	Rear right - Seat module	●	●	●	●		
Range Rover Sport	2014-2015	Body - Doors	PDM - Passengers Door Module	●	●	●	●		●
Range Rover Sport	2014-2015	Body - KVM	KVM - Keyless Vehicle Module	●	●	●	●		●
Range Rover Sport	2014-2015	Body - Running Boards	Running board control module	●	●	●	●		●
Range Rover Sport	2014-2015	Body - RGTM	RGTM - Rear Gate/Trunk Module	●	●	●	●		●
Range Rover Sport	2014-2015	Body - Object Detection	Side object detection control module - Left	●	●	●	●		
Range Rover Sport	2014-2015	Body - Object Detection	Side object detection control module - Right	●	●	●	●		
Range Rover Sport	2014-2015	Body - Proximity	General proximity sensor module	●	●	●	●		
Range Rover Sport	2014-2015	Infotainment	FCDIM - Front Control/Display Interface Module	●	●	●	●		
Range Rover Sport	2014-2015	Infotainment	FCIM - Front Control Interface Module	●	●	●	●		
Range Rover Sport	2014-2015	Infotainment	FCIMB - Front Control Interface Module '91B'92	●	●	●	●		
Range Rover Sport	2014-2015	Infotainment	IPMB - Image Processing Module '91B'92	●	●	●	●		●
Range Rover Sport	2014-2015	Infotainment	Audio front control module	●	●	●	●		●
Range Rover Sport	2014-2015	Infotainment	Digital audio broadcast module	●	●	●	●		
Range Rover Sport	2014-2015	Infotainment	Rear entertainment control module	●	●	●	●		
Range Rover Sport	2014-2015	Infotainment	Satellite audio unit module	●	●	●	●		
Range Rover Sport	2014-2015	Infotainment	Television module	●	●	●	●		
Range Rover Sport	2014-2015	Infotainment	Audio amplifier module	●	●	●	●		●
Range Rover Sport	2014-2015	Infotainment	Accessory protocol interface module	●	●	●	●		
Range Rover Sport	2014-2015	Infotainment	Connect and view module	●	●	●	●		
Range Rover Sport	2014-2015	Infotainment	Head up display	●	●	●	●		
Range Rover Sport	2014-2015	Infotainment	Head-up display cooling fan module	●	●	●	●		
Range Rover Sport	2014-2015	Battery	Battery energy control module	●	●	●	●		
Range Rover Sport	2014-2015	Battery	Electric power inverter converter module	●	●	●	●		
Range Rover Sport	2014-2015	Vehicle Network	Gateway module	●	●	●	●		●
Range Rover Sport	2014-2015	Telematics	Telematic control unit module	●	●	●	●		
Range Rover Sport	2014-2015	Navigation	Navigation control module	●	●	●	●		
Range Rover Evoque	2012-2013	Drive - Diesel EMS	PCM - Power Train Control Module (Diesel)	●	●	●	●		●
Range Rover Evoque	2012-2013	Drive - Petrol EMS	PCM - Power Train Control Module (Petrol)	●	●	●	●		●
Range Rover Evoque	2012-2013	Drive - Transmission	TCM - Transmission Control Module	●	●	●	●		●
Range Rover Evoque	2012-2013	Drive - Transmission	GSM - Gear Shift Module	●	●	●	●		
Range Rover Evoque	2012-2013	Drive - Transmission	GSMB - Gear Shift Module '91B'92	●	●	●	●		
Range Rover Evoque	2012-2013	Drive - Transmission	RDCM - Rear Differential Control Module	●	●	●	●		
Range Rover Evoque	2012-2013	Chassis - ABS/DSC	ABS / DSC - Anti-locking brake System / Dynamic Stability Control	●	●	●	●		●
Range Rover Evoque	2012-2013	Chassis - Steering Angle	SASM - Steering Angle Sensor Module	●	●	●	●		●
Range Rover Evoque	2012-2013	Chassis - Parking Brake	PBM - Park Brake Module	●	●	●	●		●
Range Rover Evoque	2012-2013	Chassis - TPMS	TPMS - Tyre Pressure Monitoring System	●	●	●	●		
Range Rover Evoque	2012-2013	Chassis - Power Steering	PSCM - Power Steering Control Module	●	●	●	●		
Range Rover Evoque	2012-2013	Chassis - Suspension	ADCM - Adaptive Damping Control Module	●	●	●	●		●
Range Rover Evoque	2012-2013	Chassis - ATCM	ATCM - All Terrain Control Module	●	●	●	●		
Range Rover Evoque	2012-2013	Body - Airbag	RCM - Restraints Control Module	●	●	●	●		●
Range Rover Evoque	2012-2013	Body - Airbag	OCS - Occupancy Classification System	●	●	●	●		●
Range Rover Evoque	2012-2013	Body - Climate Control	HVAC - Heating Ventilation Air Conditioning Control Module	●	●	●	●		●
Range Rover Evoque	2012-2013	Body - Body Controller	BCM - Body Control Module	●	●	●	●		●
Range Rover Evoque	2012-2013	Body - Instruments	IPC - Instrument Panel Control Module	●	●	●	●		●
Range Rover Evoque	2012-2013	Body - Lighting Control	HCM - Headlamp Control Module	●	●	●	●		●
Range Rover Evoque	2012-2013	Body - Lighting Control	HCMB - Headlamp Control Module '91B'92	●	●	●	●		
Range Rover Evoque	2012-2013	Body - Parking Aid	PAM - Parking Aid Module	●	●	●	●		
Range Rover Evoque	2012-2013	Body - Object Detection	SODL - Side Object Detection Control Module - Left	●	●	●	●		●
Range Rover Evoque	2012-2013	Body - Object Detection	SODR - Side Object Detection Control Module - Right	●	●	●	●		
Range Rover Evoque	2012-2013	Body - Immobiliser	Vehicle immobilizer control module	●	●	●	●		
Range Rover Evoque	2012-2013	Body - Fuel-Fired Heater	FFH - Fuel Fired Heater	●	●	●	●		●
Range Rover Evoque	2012-2013	Body - Seating	DSM - Drivers Seat Module	●	●	●	●		
Range Rover Evoque	2012-2013	Body - Seating	PSM - Passenger Seat Module	●	●	●	●		
Range Rover Evoque	2012-2013	Body - Doors	DDM - Drivers Door Module	●	●	●	●		●
Range Rover Evoque	2012-2013	Body - Doors	PDM - Passengers Door Module	●	●	●	●		
Range Rover Evoque	2012-2013	Body - KVM	KVM - Keyless Vehicle Module	●	●	●	●		●
Range Rover Evoque	2012-2013	Body - RGTM	RGTM - Rear Gate/Trunk Module	●	●	●	●		●
Range Rover Evoque	2012-2013	Infotainment	AAM - Audio Amplifier Module	●	●	●	●		
Range Rover Evoque	2012-2013	Infotainment	ACM - Audio Control Module	●	●	●	●		●
Range Rover Evoque	2012-2013	Infotainment	FCDM - Front Control / Display Interface Module	●	●	●	●		
Range Rover Evoque	2012-2013	Infotainment	FCIMB - Front Control Interface Module '91B'92	●	●	●	●		
Range Rover Evoque	2012-2013	Infotainment	DABM - Digital Audio Broadcast Module	●	●	●	●		
Range Rover Evoque	2012-2013	Infotainment	SRM - Satellite Audio Unit Module	●	●	●	●		
Range Rover Evoque	2012-2013	Infotainment	TVM - Television Module	●	●	●	●		
Range Rover Evoque	2012-2013	Infotainment	REM - Rear Entertainment Module	●	●	●	●		
Range Rover Evoque	2012-2013	Infotainment	IPMB - Image Processing Module '91B'92	●	●	●	●		●
Range Rover Evoque	2012-2013	Infotainment	Audio head unit	●	●	●	●		
Range Rover Evoque	2012-2013	Navigation	Navigation control module	●	●	●	●		

Lynx Evo Vehicle Coverage - continued

Vehicle Model	Years	System	System Name	Read Fault Codes	Clear Fault Codes	Live Data	ECM Data	Actuators	Special Functions
Range Rover Evoque	2014-2015	Drive - Diesel EMS	PCM - Power Train Control Module (Diesel)	●	●	●	●		●
Range Rover Evoque	2014-2015	Drive - Petrol EMS	PCM - Power Train Control Module (Petrol)	●	●	●	●		●
Range Rover Evoque	2014-2015	Drive - Transmission	TCM - Transmission Control Module	●	●	●	●		●
Range Rover Evoque	2014-2015	Drive - Transmission	GSM - Gear Shift Module	●	●	●	●		
Range Rover Evoque	2014-2015	Drive - Transmission	RDCM - Rear Differential Control Module	●	●	●	●		
Range Rover Evoque	2014-2015	Drive - Cruise Control	Speed control module	●	●	●	●		●
Range Rover Evoque	2014-2015	Chassis - ABS/DSC	ABS / DSC - Anti-locking brake System / Dynamic Stability Control	●	●	●	●		●
Range Rover Evoque	2014-2015	Chassis - Steering Angle	SASM - Steering Angle Sensor Module	●	●	●	●		●
Range Rover Evoque	2014-2015	Chassis - TPMS	TPMS - Tyre Pressure Monitoring System	●	●	●	●		
Range Rover Evoque	2014-2015	Chassis - Parking Brake	PBM - Park Brake Module	●	●	●	●		●
Range Rover Evoque	2014-2015	Chassis - Power Steering	PSCM - Power Steering Control Module	●	●	●	●		
Range Rover Evoque	2014-2015	Chassis - Suspension	ADCM - Adaptive Damping Control Module	●	●	●	●		●
Range Rover Evoque	2014-2015	Chassis - All Wheel Drive	All wheel drive control module	●	●	●	●		
Range Rover Evoque	2014-2015	Chassis - ATCM	ATCM - All Terrain Control Module	●	●	●	●		
Range Rover Evoque	2014-2015	Body - Airbag	RCM - Restraints Control Module	●	●	●	●		●
Range Rover Evoque	2014-2015	Body - Airbag	OCS - Occupancy Classification System	●	●	●	●		●
Range Rover Evoque	2014-2015	Body - Climate Control	HVAC - Heating Ventilation Air Conditioning Control Module	●	●	●	●		●
Range Rover Evoque	2014-2015	Body - Body Controller	BCM - Body Control Module	●	●	●	●		●
Range Rover Evoque	2014-2015	Body - Instruments	IPC - Instrument Panel Control Module	●	●	●	●		●
Range Rover Evoque	2014-2015	Body - Lighting Control	HCM - Headlamp Control Module	●	●	●	●		●
Range Rover Evoque	2014-2015	Body - Lighting Control	HCMB - Headlamp Control Module '91B'92	●	●	●	●		
Range Rover Evoque	2014-2015	Body - Proximity	General proximity sensor module	●	●	●	●		
Range Rover Evoque	2014-2015	Body - Parking Aid	PAM - Parking Aid Module	●	●	●	●		
Range Rover Evoque	2014-2015	Body - Object Detection	SODL - Side Object Detection Control Module - Left	●	●	●	●		
Range Rover Evoque	2014-2015	Body - Object Detection	SODR - Side Object Detection Control Module - Right	●	●	●	●		
Range Rover Evoque	2014-2015	Body - Immobiliser	Vehicle immobilizer control module	●	●	●	●		
Range Rover Evoque	2014-2015	Body - Fuel-Fired Heater	FFH - Fuel Fired Heater	●	●	●	●		●
Range Rover Evoque	2014-2015	Body - Seating	DSM - Drivers Seat Module	●	●	●	●		●
Range Rover Evoque	2014-2015	Body - Seating	PSM - Passenger Seat Module	●	●	●	●		●
Range Rover Evoque	2014-2015	Body - Doors	DDM - Drivers Door Module	●	●	●	●		●
Range Rover Evoque	2014-2015	Body - Doors	PDM - Passengers Door Module	●	●	●	●		●
Range Rover Evoque	2014-2015	Body - KVM	KVM - Keyless Vehicle Module	●	●	●	●		●
Range Rover Evoque	2014-2015	Body - RGTM	RGTM - Rear Gate/Trunk Module	●	●	●	●		●
Range Rover Evoque	2014-2015	Infotainment	AAM - Audio Amplifier Module	●	●	●	●		●
Range Rover Evoque	2014-2015	Infotainment	ACM - Audio Control Module	●	●	●	●		
Range Rover Evoque	2014-2015	Infotainment	FCDM - Front Control / Display Interface Module	●	●	●	●		
Range Rover Evoque	2014-2015	Infotainment	FCIMB - Front Control Interface Module '91B'92	●	●	●	●		
Range Rover Evoque	2014-2015	Infotainment	DABM - Digital Audio Broadcast Module	●	●	●	●		
Range Rover Evoque	2014-2015	Infotainment	SRM - Satellite Audio Unit Module	●	●	●	●		
Range Rover Evoque	2014-2015	Infotainment	TVM - Television Module	●	●	●	●		
Range Rover Evoque	2014-2015	Infotainment	Head up display	●	●	●	●		
Range Rover Evoque	2014-2015	Infotainment	Connect and view module	●	●	●	●		
Range Rover Evoque	2014-2015	Infotainment	Head-up display cooling fan module	●	●	●	●		
Range Rover Evoque	2014-2015	Infotainment	REM - Rear Entertainment Module	●	●	●	●		
Range Rover Evoque	2014-2015	Infotainment	IPMB - Image Processing Module '91B'92	●	●	●	●		
Range Rover Evoque	2014-2015	Infotainment	Audio head unit	●	●	●	●		
Range Rover Evoque	2014-2015	Navigation	Navigation control module	●	●	●	●		
Range Rover Evoque	2014-2015	Telematics	Telematic control unit module	●	●	●	●		
Range Rover Evoque	2014-2015	Vehicle Network	Gateway module	●	●	●	●		●
Range Rover Evoque	2016	Drive - Diesel EMS	PCM - Power Train Control Module (Diesel)	●	●	●	●		
Range Rover Evoque	2016	Drive - Petrol EMS	PCM - Power Train Control Module (Petrol)	●	●	●	●		
Range Rover Evoque	2016	Drive - Transmission	TCM - Transmission Control Module	●	●	●	●		
Range Rover Evoque	2016	Drive - Transmission	GSM - Gear Shift Module	●	●	●	●		
Range Rover Evoque	2016	Drive - Transmission	RDCM - Rear Differential Control Module	●	●	●	●		
Range Rover Evoque	2016	Drive - Cruise Control	Speed control module	●	●	●	●		
Range Rover Evoque	2016	Chassis - ABS/DSC	ABS / DSC - Anti-locking brake System / Dynamic Stability Control	●	●	●	●		
Range Rover Evoque	2016	Chassis - Steering Angle	SASM - Steering Angle Sensor Module	●	●	●	●		
Range Rover Evoque	2016	Chassis - Parking Brake	PBM - Park Brake Module	●	●	●	●		
Range Rover Evoque	2016	Chassis - Power Steering	PSCM - Power Steering Control Module	●	●	●	●		
Range Rover Evoque	2016	Chassis - Suspension	ADCM - Adaptive Damping Control Module	●	●	●	●		
Range Rover Evoque	2016	Chassis - All Wheel Drive	All wheel drive control module	●	●	●	●		
Range Rover Evoque	2016	Chassis - ATCM	ATCM - All Terrain Control Module	●	●	●	●		
Range Rover Evoque	2016	Chassis - TPMS	Tyre pressure monitor module	●	●	●	●		
Range Rover Evoque	2016	Body - Airbag	RCM - Restraints Control Module	●	●	●	●		
Range Rover Evoque	2016	Body - Airbag	OCS - Occupancy Classification System	●	●	●	●		
Range Rover Evoque	2016	Body - Climate Control	HVAC - Heating Ventilation Air Conditioning Control Module	●	●	●	●		
Range Rover Evoque	2016	Body - Body Controller	BCM - Body Control Module	●	●	●	●		
Range Rover Evoque	2016	Body - Instruments	IPC - Instrument Panel Control Module	●	●	●	●		
Range Rover Evoque	2016	Body - Lighting Control	HCM - Headlamp Control Module	●	●	●	●		
Range Rover Evoque	2016	Body - Lighting Control	HCMB - Headlamp Control Module '91B'92	●	●	●	●		
Range Rover Evoque	2016	Body - Proximity	General proximity sensor module	●	●	●	●		
Range Rover Evoque	2016	Body - Parking Aid	PAM - Parking Aid Module	●	●	●	●		
Range Rover Evoque	2016	Body - Object Detection	SODL - Side Object Detection Control Module - Left	●	●	●	●		
Range Rover Evoque	2016	Body - Object Detection	SODR - Side Object Detection Control Module - Right	●	●	●	●		
Range Rover Evoque	2016	Body - Immobiliser	Vehicle immobilizer control module	●	●	●	●		
Range Rover Evoque	2016	Body - Fuel-Fired Heater	FFH - Fuel Fired Heater	●	●	●	●		
Range Rover Evoque	2016	Body - Seating	DSM - Drivers Seat Module	●	●	●	●		
Range Rover Evoque	2016	Body - Seating	PSM - Passenger Seat Module	●	●	●	●		
Range Rover Evoque	2016	Body - Doors	DDM - Drivers Door Module	●	●	●	●		
Range Rover Evoque	2016	Body - Doors	Drivers Side Rear Door Module	●	●	●	●		
Range Rover Evoque	2016	Body - Doors	PDM - Passengers Door Module	●	●	●	●		
Range Rover Evoque	2016	Body - Doors	Passengers Side Rear Door Module	●	●	●	●		
Range Rover Evoque	2016	Body - KVM	KVM - Keyless Vehicle Module	●	●	●	●		
Range Rover Evoque	2016	Body - RGTM	RGTM - Rear Gate/Trunk Module	●	●	●	●		
Range Rover Evoque	2016	Infotainment	Head-up display cooling fan module	●	●	●	●		
Range Rover Evoque	2016	Infotainment	Connect and view module	●	●	●	●		
Range Rover Evoque	2016	Infotainment	Front control/display interface module (high level display front)	●	●	●	●		

Lynx Evo Vehicle Coverage - continued

Vehicle Model	Years	System	System Name	Read Fault Codes	Clear Fault Codes	Live Data	ECM Data	Actuators	Special Functions
Range Rover Evoque	2016	Infotainment	Head up display	●	●	●	●		
Range Rover Evoque	2016	Infotainment	InControl Touch audio head unit	●	●	●	●		
Range Rover Evoque	2016	Infotainment	Image processing module B	●	●	●	●		
Range Rover Evoque	2016	Infotainment	Audio amplifier module	●	●	●	●		
Range Rover Evoque	2016	Infotainment	Audio front control module	●	●	●	●		
Range Rover Evoque	2016	Infotainment	Digital audio broadcast module	●	●	●	●		
Range Rover Evoque	2016	Infotainment	Rear entertainment control module	●	●	●	●		
Range Rover Evoque	2016	Infotainment	Satellite audio unit module	●	●	●	●		
Range Rover Evoque	2016	Infotainment	Image processing control module A	●	●	●	●		
Range Rover Evoque	2016	Infotainment	Television module	●	●	●	●		
Range Rover Evoque	2016	Navigation	Navigation control module	●	●	●	●		
Range Rover Evoque	2016	Telematics	Telematic control unit module	●	●	●	●		
Range Rover Evoque	2016	Vehicle Network	Gateway module	●	●	●	●		
Range Rover Evoque	2017	Drive - Diesel EMS	PCM - Power Train Control Module (Diesel)	●	●	●	●		
Range Rover Evoque	2017	Drive - Petrol EMS	PCM - Power Train Control Module (Petrol)	●	●	●	●		
Range Rover Evoque	2017	Drive - Transmission	TCM - Transmission Control Module	●	●	●	●		
Range Rover Evoque	2017	Drive - Transmission	GSM - Gear Shift Module	●	●	●	●		
Range Rover Evoque	2017	Drive - Transmission	RDCM - Rear Differential Control Module	●	●	●	●		
Range Rover Evoque	2017	Drive - Cruise Control	Speed control module	●	●	●	●		
Range Rover Evoque	2017	Chassis - ABS/DSC	ABS / DSC - Anti-locking brake System / Dynamic Stability Control	●	●	●	●		
Range Rover Evoque	2017	Chassis - Steering Angle	SASM - Steering Angle Sensor Module	●	●	●	●		
Range Rover Evoque	2017	Chassis - Parking Brake	PBM - Park Brake Module	●	●	●	●		
Range Rover Evoque	2017	Chassis - Power Steering	PSCM - Power Steering Control Module	●	●	●	●		
Range Rover Evoque	2017	Chassis - Suspension	ADCM - Adaptive Damping Control Module	●	●	●	●		
Range Rover Evoque	2017	Chassis - All Wheel Drive	All wheel drive control module	●	●	●	●		
Range Rover Evoque	2017	Chassis - ATCM	ATCM - All Terrain Control Module	●	●	●	●		
Range Rover Evoque	2017	Chassis - TPMS	Tyre pressure monitor module	●	●	●	●		
Range Rover Evoque	2017	Body - Airbag	RCM - Restraints Control Module	●	●	●	●		
Range Rover Evoque	2017	Body - Airbag	OCS - Occupancy Classification System	●	●	●	●		
Range Rover Evoque	2017	Body - Climate Control	HVAC - Heating Ventilation Air Conditioning Control Module	●	●	●	●		
Range Rover Evoque	2017	Body - Body Controller	BCM - Body Control Module	●	●	●	●		
Range Rover Evoque	2017	Body - Instruments	IPC - Instrument Panel Control Module	●	●	●	●		
Range Rover Evoque	2017	Body - Lighting Control	HCM - Headlamp Control Module	●	●	●	●		
Range Rover Evoque	2017	Body - Lighting Control	HCMB - Headlamp Control Module '91B'92	●	●	●	●		
Range Rover Evoque	2017	Body - Proximity	General proximity sensor module	●	●	●	●		
Range Rover Evoque	2017	Body - Parking Aid	PAM - Parking Aid Module	●	●	●	●		
Range Rover Evoque	2017	Body - Object Detection	SODL - Side Object Detection Control Module - Left	●	●	●	●		
Range Rover Evoque	2017	Body - Object Detection	SODR - Side Object Detection Control Module - Right	●	●	●	●		
Range Rover Evoque	2017	Body - Immobiliser	Vehicle immobilizer control module	●	●	●	●		
Range Rover Evoque	2017	Body - Fuel-Fired Heater	FFH - Fuel Fired Heater	●	●	●	●		
Range Rover Evoque	2017	Body - Seating	DSM - Drivers Seat Module	●	●	●	●		
Range Rover Evoque	2017	Body - Seating	PSM - Passenger Seat Module	●	●	●	●		
Range Rover Evoque	2017	Body - Doors	DDM - Drivers Door Module	●	●	●	●		
Range Rover Evoque	2017	Body - Doors	Drivers Side Rear Door Module	●	●	●	●		
Range Rover Evoque	2017	Body - Doors	PDM - Passengers Door Module	●	●	●	●		
Range Rover Evoque	2017	Body - Doors	Passengers Side Rear Door Module	●	●	●	●		
Range Rover Evoque	2017	Body - KVM	KVM - Keyless Vehicle Module	●	●	●	●		
Range Rover Evoque	2017	Body - Folding Top	Folding top control module	●	●	●	●		
Range Rover Evoque	2017	Body - Folding Top	Folding top control module B	●	●	●	●		
Range Rover Evoque	2017	Body - RGTM	RGTM - Rear Gate/Trunk Module	●	●	●	●		
Range Rover Evoque	2017	Infotainment	Head-up display cooling fan module	●	●	●	●		
Range Rover Evoque	2017	Infotainment	Connect and view module	●	●	●	●		
Range Rover Evoque	2017	Infotainment	Front control/display interface module (high level display front)	●	●	●	●		
Range Rover Evoque	2017	Infotainment	Head up display	●	●	●	●		
Range Rover Evoque	2017	Infotainment	InControl Touch audio head unit	●	●	●	●		
Range Rover Evoque	2017	Infotainment	InControl Touch Pro infotainment master controller	●	●	●	●		
Range Rover Evoque	2017	Infotainment	InControl Touch Pro audio amplifier module	●	●	●	●		
Range Rover Evoque	2017	Infotainment	Image processing module B	●	●	●	●		
Range Rover Evoque	2017	Infotainment	Audio amplifier module	●	●	●	●		
Range Rover Evoque	2017	Infotainment	Audio front control module	●	●	●	●		
Range Rover Evoque	2017	Infotainment	Digital audio broadcast module	●	●	●	●		
Range Rover Evoque	2017	Infotainment	Rear entertainment control module	●	●	●	●		
Range Rover Evoque	2017	Infotainment	Satellite audio unit module	●	●	●	●		
Range Rover Evoque	2017	Infotainment	Image processing control module A	●	●	●	●		
Range Rover Evoque	2017	Infotainment	Television module	●	●	●	●		
Range Rover Evoque	2017	Navigation	Navigation control module	●	●	●	●		
Range Rover Evoque	2017	Telematics	Telematic control unit module	●	●	●	●		
Range Rover Evoque	2017	Vehicle Network	Gateway module	●	●	●	●		



Photo courtesy of Paul Spense

Calibration Tools

LRT-60-003



LRT-60-003
Range Rover P38

LRT-64-003

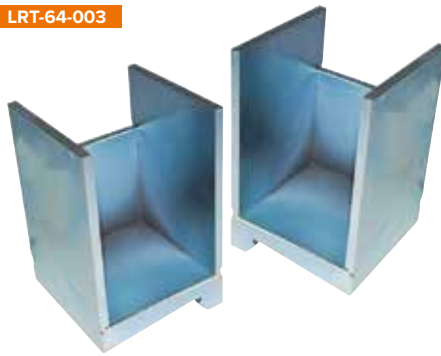

LRT-64-003
Discovery 2

To help with air suspension calibration we also offer these calibration blocks which can be used in conjunction with our Lynx diagnostics kit.



Lynx Replacement Parts



DA6430CABLE NEW

Replacement ODB to VCI cable for Lynx Diagnostics units

iCarsoft Multi-system Scanner **NEW**

DA1600 NEW

iCarsoft Multi-system Scanner i930

i930 for Land Rover is a vehicle fault diagnostic tool. It's a powerful DIY tool, test modes include: CANBUS, ISO9141, KWP2000, J1850 etc..

Features

- > Read DTCs
- > Clear DTCs
- > Read live data stream
- > Single brand of all models (OBDII-16 DLC)
- > Full system diagnosis
- > Upgrade via USB 2.0
- > Multi-language

Vehicle Coverage

- > Freelander
- > Freelander 2
- > Defender
- > Discovery 2
- > Discovery 3
- > Discovery 4
- > Range Rover Sport
- > Range Rover
- > Range Rover Evoque

System Coverage

- > Engine
- > PCM
- > TCM/Gearbox
- > ABS
- > RCM/SRS/Airbag
- > ICCM/IP
- > RLCM /Air Suspension
- > BCM/BODY
- > HVAC/Air Conditioning
- > VDCM
- > SASM/Steering
- > TPM
- > PBM
- > Parking Assist
- > Parking Aid
- > AHCM
- > VICM/Security/Immo
- > DDM
- > DSM

System Coverage - continued

- > PDM
- > PSM
- > ATCM
- > TCCM/Transfer Box
- > ADCM
- > SCM
- > DRM
- > Rain Sensor
- > GSM
- > Light Check/Lighting
- > OCS
- > HCM
- > ICM
- > KVM
- > Television

Specifications

- > Display: 2.8" colour screen, 320 x 240 pixels display with contrast adjustment
- > Operation temperature: 0°C - 50°C
- > Storage temperature: -20°C - 70°C
- > Power: 9V - 18V
- > Operating current: 100mA @ 12V (typical)
- > Power consumption: 1.2W (typical)
- > Dimension: 121mm x 86mm x 26mm - (L x W x H)
- > Weight: 300g

Contents

- > Hardcopy user manual
- > 3-foot OBD II cable
- > USB cable
- > Nylon carry case

Support Multi-Languages

- > English
- > German
- > Spanish
- > French
- > Portuguese
- > Russian
- > Dutch

OBDII Function

- > I/M Readiness - I/M Readiness indicates whether or not the various emissions-related systems on the vehicle are operating properly and are ready for Inspection and Maintenance testing.
- > Freeze frame - When an emission-related fault occurs, certain vehicle conditions are recorded by the on-board computer. This information is referred to as freeze frame data. Freeze data is a snapshot of the operating conditions at the time of an emission-related fault.
- > O2 Sensor test - This option allows retrieval and viewing of O2 sensor test results for most recently performed tests from the vehicle's on-board computer.
- > On-Board monitoring - This function can be utilized to read the results of on-board diagnostic monitoring tests for specific components/systems.
- > Evap system test - The EVAP test function lets you initiate a leak test for the vehicle's EVAP system. Before using the system test function, refer to the vehicle's service repair manual to determine the procedures necessary to stop the test.
- > Vehicle information - The option displays the vehicle identification number (VIN), the calibration verification number (CVN), and other information of the test vehicle.
- > Retrieve generic (P0, P2, P3, and U0), manufacturer specific (P1, P3, and U1) codes and pending codes.
- > Turn off Check Engine Light (MIL), clear codes and reset monitors.
- > Multilingual menu and DTC definitions- English, Spanish, and German, etc.



Photo courtesy of David Holman

iCarsoft

Repair & Service

Keeping your Land Rover in good condition can require a range of specialist tools and service equipment. We have an extensive range of repair and service parts from engine oils to a complete chassis to ensure that your Land Rover gets the treatment it deserves!

Repair & Service Parts

Axle/Steering/Suspension

Air suspension compressors	162
Front hub, bearing & upright assembly	163
Steering box repair kit	162
Steering rack ball joint repair kits	162
Stub axle kits	162
Suspension ball joint repair kits	163
Suspension bolt kits	163
Swivel housing kits	162
Swivel oil seal retainers	162
Swivel pin kits	162
Wheel bearing kits	163
Wheel hub assemblies	163

Braking

Anti-squeal shims	164
Brake fitting kit	164
Brake & clutch reservoir tanks	164
Brake kits	164
Brake lubrication	166
Brake pipe sets	164
Parking brake spring kits	164
Stainless steel brake calliper pistons & kits	166
XD brake pads	165
XS brake discs	166
XS brake pads	165

Electrics

Alternator upgrade kits	167
Electronic conversion kits	167
Electronic distributors	167
Ignition lead sets	167
Ignition module & link lead	167
Programmable wiper relay	167
Windscreen wiper motors	167

Engine

Aluminium rockers	170
Cylinder heads	168
Cylinder head overhaul kits	171
Cylinder liner kit	168
Engines	169
Engine bay enhancements	172
Exhaust fitting kits	171
Filters - bulk	168
Fuel filter holder	169
Gaskets & head bolt sets	168
Heater plug upgrade kit	169
Injector pipe sets	168
Injector washer kits	169
Main bearing sets	168
Manifold assembly fuel sensor	171
Manifold inlet seal	169
Manifold link	171
Oil cooler repair kit	169
Oil pump gear set	169
Pistons & ring sets	170
Powerlite starter motors & Dynalite alternator	167
Pressure relief valve	169
Radiator hose kit	171
Td5 oil pump	171
Td5 short oil filter	169
TdV6 engine parts	171
Timing belt kits	169
Top hat liner set	169
Water sensor repair kit	170
XS water pumps	170

Heating

Heater blower motor kit & resistor kit	173
Heater matrixes	173
Valve unit	173

Transmission

Auto trans filter conversion & service kits	173
Auto trans lever parts	176
Brake & clutch reservoir	176
Clutches	175

Clutch pedal assist	174
Crown wheel & pinion	174
CV joint kits	174
Damper kit	173
Detent repair springclip	174
Diff coupling shaft	173
Diff overhaul kits	176
Diff rebuild kit	176
Diff repair pans	173
Double cardan repair kit	176
Gearboxes	174
Gear change kits	174
Gearbox bearing kits	174
IRD repair kit	174
Propshaft bearings	174
Rear AWD coupling parts	176
Rear diff & carriers	176
Transfer boxes	176

Chassis & Body Components

Chassis - Complete Galvanised Frames

Chassis & Body Components

Defender	179
Discovery 1	180
Discovery 2	180
Range Rover Classic	181
Series 2 & 3	182
Other	183

Door Hinge Kits

Door Lock Button Kit

Fuel Latch Repair Kit

Fuel Tank Fitting Kit

Galvanised & Stainless Steel Products

Tailgate Half Door Kit

Tailgate Hinge Brackets

Window Kits

Service kits

Automatic Transmission Fluid Change Kits

Service Kits

Defender	185
Discovery	186
Freelander	186
Range Rover	187 - 188
Series	185

Service Stickers

Consumables

Bearing Grease	189
Brake Cleaner	189
Bulk Workshop Fasteners	189
Castrol Classic Oils	194
Clips, Clamps & Nipples	189
Dinitrol Products	197
Loctite Consumables	198
Hylomar Sealants & Compounds	189
Isocon Repair Consumables	196
Oil Analysis Kit	193
Raptor	195
Ravenol Classic Oils	194
Ravenol Workshop Consumables	192 - 193
Swivel Housing Grease	189
Touch Up Paint Pens	198
Trade Tack Stab	189
Workshop Consumables	190 - 191

Tools

Automatic Transmission Flush & Fill Machine	204
Calibration Tools	199
Lighting	203
Timing Tools	199
Workshop Tools	200 - 202



Axle, Steering & Suspension

Swivel Housing Kits

DA2992



Castor Corrected Swivel Housings

These are a direct replacement for vehicles normally using the FRC7065 swivel housing but they have the mounting holes positioned to give 3 degrees of additional castor. Full details in the suspension section.

DA3203 Based on DA3178 kit

Defender - from LA up to WA

DA2992 Based on DA3165 kit

Discovery 1 - JA32851 onwards - non-ABS

Range Rover Classic - JA624517 onwards - non-ABS

Swivel Oil Seal Retainers NEW

RRY500180SS

RRY500180SS



FRC4142SS NEW

Defender/Discovery 1/Range Rover Classic

RRY500180SS NEW

24 spline

Defender/Discovery 1/Range Rover Classic

Corroded, worn or leaking swivel housings?

These ten swivel housing kits from Britpart are a convenient way to ensure you have all the quality parts needed to replace a Land Rover's swivel housing.

Discovery 1 - up to JA32850 - with 12mm seals Range Rover Classic - from 1985 up to JA624516 - with 12mm seals	DA3163	DA3163P	DA3163G
Contents - Swivel housing; swivel pin bearing; gasket; seals; plate; shims; joint washers; swivel pin upper & swivel housing grease sachet			
Discovery 1 - up to JA32850 - with 8mm seals Range Rover Classic - up to JA624516 - with 8mm seals	DA3164	DA3164P	DA3164G
Contents - Swivel housing; swivel pin bearing; gasket; oil seals; plate; shims; joint washers; swivel pin upper & swivel housing grease sachet			
Discovery 1 - JA32851 onwards - non-ABS Range Rover Classic - JA624517 onwards - non-ABS	DA3165	DA3165P	DA3165G
Contents - Swivel housing; swivel pin bearing; gasket; seals; plate; shims; joint washers; swivel pin upper - non-ABS & swivel housing grease sachet			
Discovery 1 - with ABS Range Rover Classic - with ABS	DA3166	DA3166P	DA3166G
Contents - Swivel housing; swivel pin bearing; gasket; seals; plate; shims; joint washers; swivel pin kit - upper - ABS & swivel housing grease sachet			
Defender - up to KA930455	DA3167	DA3167P	DA3167G
Contents - Swivel housing; housing and bush; thrust washer; swivel pin bearing; joint washers; seals; shims; swivel pin upper & swivel housing grease sachet			
Defender - from LA up to WA	DA3178	DA3178P	DA3178G
Contents - Swivel housing; swivel pin bearing; gasket; seals; plate; shims; joint washers; swivel pin upper - non-ABS & swivel housing grease sachet			
Defender - XA onwards - non-ABS			
Contents - Swivel housing; swivel pin bearing; gasket; seals; plate; joint washers; swivel pin kit & swivel housing grease sachet	DA3179	DA3179P DA3179PG OEM kit	DA3179G
Defender - XA onwards - with ABS	DA3180	DA3180P	DA3180G
Contents - Swivel housing; swivel pin bearing; gasket; seals; plate; joint washers; swivel pin kit & swivel housing grease sachet			
Series 2	DA3169	DA3169P	
Contents - Swivel housing; swivel pin; railko bush; thrust washer; swivel pin bearing; o-ring; lock washer; locker; shims; oil seal; retainer for oil seal; joint washers & swivel housing grease sachet			
Series 2A/Series 3	DA3181	DA3181P	
Contents - Swivel housing; swivel pin; railko bush; thrust washer; swivel pin bearing; o-ring; lock washer; locker; shims; oil seal; retainer for oil seal; joint washers & swivel housing grease sachet			

Note Kit is for one side only. For full details of each kit list - www.britpart.com/swivelkits

Blue part numbers - full kit with swivel housing; **Red 'P'** part numbers - repair kit without swivel housing;

Green 'G' part numbers - full kit with swivel housing & OEM seals



Photo courtesy of Andy Yung

Air Suspension Compressors

LR023964



Discovery 3 - up to 9A513325
Range Rover Sport - up to 9A215622

DA3965

Complete Hitachi compressor kit

LR015303 & **LR023964**

Hitachi compressor & relay

LR023964G NEW

Hitachi compressor & genuine LR relay

Range Rover L322 - from 6A198058 up to CA393639

LR015089 & **LR025111**

Hitachi compressor & relay

DA3964

Hitachi compressor pipe/install kit

LR078650



Full details on these compressors can be found in the suspension section.

Discovery 3

Discovery 4

Range Rover Sport - Mk1

LR072537

Complete AMK compressor kit

LR078650

AMK compressor, relay, bracket & fixings

LR044034

Bracket only

DA1888

AMK compressor pipe/install kit

Stub Axle Kits

Front Kits

DA3190

Defender - up to KA

DA3191

Defender - from LA

DA3192

Defender - from 2007 onwards

DA3193

Discovery 1 - up to JA032850

DA3194

Discovery 1 - from JA032851

DA3195

Range Rover Classic

- from JA624517

Rear Kits

DA3198

Defender 90 - from LA930456

Defender 110 - from WA769311

DA3199

Defender - 110/130 from LA with Salisbury axle up to WA769310

DA3358

Defender - up to KA. Up to axle 22S8283

DA3359

Defender - up to KA. From axle 22S8283

DA3196

Discovery 1 - up to JA032850/Range Rover Classic - up to JA032850

DA3197

Discovery 1 - from JA032851/Range Rover Classic - from JA032851

DA3191



Handy kits when changing your Land Rover's stub axle!

Steering Box Repair Kit

DA1236

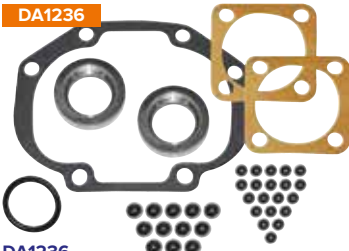

DA1236

Series 2, 2A & 3

Steering Rack Ball Joint Repair Kits

LR010673



LR010673

Range Rover Sport

2005 - 2013 - M14 ball joints

LR010674

Range Rover Sport - 2005 - 2009 - M12 ball joints

Swivel Pin Kits

DA2178



532268

Series 2 - conversion

DA2178

Series 3

DA2211

Defender - up to KA930455

DA2210

Defender - from LA930456 up to WA159806

DA2211



Suspension Bolt Kits

DA7202



DA7202 Defender - up to KA930455
 Front suspension - radius arms & panhard rod bolts
DA7200 Defender - LA930456 to WA159806
 Front suspension - radius arms & panhard rod bolts
DA7203 Defender - XA159807 to 2A626645
 Front suspension - radius arms & panhard rod bolts
DA7204 Defender - 2A625546 onwards
 Front suspension - radius arms & panhard rod bolts
DA7201 Defender - up to YA185790
 Rear suspension - trailing arms & a-frame bolts
DA7208 Defender - YA185791 onwards
 Rear suspension - trailing arms & a-frame bolts

DA7212

Discovery 3/Discovery 4/Range Rover Sport - 2005 - 2012
 Front upper suspension arm Single
DA7205
 Discovery 3/Discovery 4/Range Rover Sport - 2005 - 2012
 Front lower suspension arm Single
Note - This kit includes a 1.5mm pitch threaded nut, please check the thread pitch on your drive shaft before changing. If you require the 2mm pitch nut, please order LR024151.
DA7207
 Discovery 3/Discovery 4/Range Rover Sport - 2005 - 2012
 Rear upper suspension arm Single
DA7206
 Discovery 3/Discovery 4/Range Rover Sport - 2005 - 2012
 Rear lower suspension arm Single

Suspension Ball Joint Repair Kits



Using these replacement ball joint kits is a cost effective way to repair the Freelander front suspension arm.

Freelander 1 - up to 5A999999
RBJ102920/930BJ
RBJ102920/930BJG - OEM
 Freelander 1 - from 6A000001
RBJ500680/690BJ
RBJ500680/690BJG - OEM
LR007205-6BJ
 Freelander 2
 Ball joint for LR007205 & LR007206

RBJ500680/690BJG

RBJ102920/930BJG

Suspension arm not included.

LR007205-6BJ

Front Hub, Bearing & Upright Assembly



Freelander 2
 Replacement front hub, bearing & upright complete assembly. Offers a quick and cheaper alternative to replacing wheel bearing or hub as separate items, saving time and money.

DA1213 Right hand side
DA1214 Left hand side

Wheel Hub Assemblies



LR014147
 Wheel hub & bearing assembly kit - front
 Discovery 3/Discovery 4
 Range Rover Sport - 2005 - 2013



576844



DA1388



TAY100050L

Series 2A - from suffix H/Series 3 - up to Sept 1980
DA1388 NEW - Wheel hub & bearing **576844** - Wheel hub only
 Series 3 - All from October 1980 onwards/ Series 3 - All V8
DA1389 NEW - Wheel hub & bearing **FRC3875** - Wheel hub only

Discovery 2 Long Sensor Lead
 Land Rover recognised that on some Discovery 2 vehicles the wiring from the ABS sensor to the ECU could get damaged. This would result in the vehicle recording ABS faults that cannot be corrected by either a sensor or hub replacement. Their solution was to produce a sensor with a very long lead that bypassed the damaged lead. This hub assembly is a complete unit with this type of ABS sensor and lead.

TAY100060L Front
TAY100050L Rear

Wheel Bearing Kits

RTC3534G



DA2379



DA2384G



Britpart Kits	OEM Kits		
RTC3534	RTC3534G	Series 2/Series 3 - SWB/LWB up to 1980 - imperial	Front & rear
RTC3537	RTC3537G	Series 3 - SWB/LWB - 1980 onwards - metric	Front & rear
DA2379	DA2379G	Defender - up to KA	Front
DA2380	DA2380G	Defender - up to KA	Rear
DA2381	DA2381G	Defender - LA onwards	Front & rear
DA2382	DA2382G	Discovery 1 - up to JA032850	Front & rear
DA2383	DA2383G	Discovery 1 - JA032851 onwards	Front & rear
DA2385	DA2385G	Range Rover Classic - non-ABS - up to JA624516	Rear
DA2384	DA2384G	Range Rover Classic - non-ABS - JA624517 on	Rear
DA2386	DA2386G	Range Rover Classic - ABS	Rear
DA2387	DA2387G	Range Rover Classic - ABS	Front
DA2388	DA2388G	Range Rover Classic - non-ABS	Front
FTC1507		Range Rover P38 Note - Bearing only	Front & rear

DA2387



Braking

DA7202



Ready Made Brake Pipe Sets

- > Easily fitted
- > Will not rust

Copper nickel brake pipe sets manufactured in the UK. Each kit is complete for a specific Land Rover model. Pipes are cut to the correct length, fitted with solid brass unions and marked clearly to indicate the correct location on the Land Rover. Pipe fitting clips and brass in-line connectors are supplied where necessary. More brake pipe kits available on request.



DA7440
Brake pipe bending tool. Can be used with all the brake pipe kits.

Brake Kits

DA6042



Defender

DA6507	Rear	90 - up to HA701009
DA6508	Rear	90 - HA701010 onwards
DA6509	Rear	110/130 - up to KA930545

Series - SWB

DA6042	Front	Up to June 1980
DA6043	Rear	Up to June 1980
DA6044	Front	July 1980 onwards
DA6046	Rear	July 1980 onwards

Series - LWB

DA6044	Front	4 cylinder except 1 ton
DA6045	Front	6 cylinder & 109 V8 Stage 1
DA6047	Rear	Including V8

Kits include - Brake shoes, wheel cylinders, brake springs & screws (where applicable)



facebook.com/britpart

Brake & Clutch Reservoir Tanks

271581

Series 1
Brake fluid supply tank



504105G NEW

Series 2
Series 2A
Replacement combined brake and clutch reservoir serves both the brake and clutch master cylinders. An internal wall avoids a failure of both systems if one develops a leak. Reservoir is as per original design.



Brake Pipe Sets

DA7443	Series 1		RHD	80 inch
DA7442	Series 1		RHD	86 inch
DA7400	Series 2	SWB	RHD	1958 - 1961. From chassis 141900105 to suffix F inclusive 4-cylinder
DA7428	Series 2	SWB	LHD	1958 -1969 suffix F. 4-cylinder from chassis 141900105 to suffix F
DA7429	Series 2A	SWB	LHD	1969 4-cylinder to suffix G
DA7401	Series 2A	SWB	RHD	4-cylinder up to 1969 suffix G
DA7402	Series 2A	LWB	RHD	09/1961 - 01/1969 4-cylinder up to suffix F
DA7405	Series 2A	LWB	RHD	6-cylinder with servo up to 1969 to suffix F
DA7406	Series 2A	LWB	RHD	From 04/1969 suffix G. No servo 6-cylinder from suffix G.
DA7403	Series 3	SWB	RHD	Single line 4-cylinder & 6-cylinder
DA7407	Series 3	SWB	RHD	Dual lightweight up to 07/1980
DA7409	Series 3	SWB	RHD	Dual to early 1980
DA7412	Series 3	SWB	RHD	Lightweight dual up to 1975 with servo to chassis 95102970A
DA7413	Series 3	SWB	RHD	Dual up to 07/1980. Civilian body metric & imperial system
DA7430	Series 3	SWB	LHD	No servo
DA7432	Series 3	SWB	LHD	Dual system to early 1980
DA7446	Series 3 NEW	SWB	LHD	From July 1980
DA7404	Series 3	LWB	RHD	4-cylinder & 6-cylinder single line From 07/1980 & air portable lightweight from July 1980 onwards & 1981 V8 dual
DA7408	Series 3	LWB	RHD	Up to 06/1980 dual. 4-cylinder up to 06/1980 & V8 up to 09/1980
DA7410	Series 3	LWB	RHD	Single line 4-cylinder & 6-cylinder
DA7411	Defender	90	RHD	1985 - 1991 to VIN HA
DA7418	Defender	90	RHD	With front brake valve less ABS LA930456 - WA159806
DA7441	Defender	90	RHD	Less front brake valve less ABS LA930456 - WA159806
DA7439	Defender	90	LHD	1992 onwards from JA up to 2004
DA7420	Defender	110	RHD	1983 - 1987
DA7414	Defender	110	RHD	1988 - 1991 VIN HA90219
DA7438	Defender	110	RHD	CSW from VIN KA & LA models from 1993. Less ABS
DA7419	Defender	130	RHD	CSW from 1994 VIN LA
DA7415	Discovery 1	200Tdi	RHD	Up to VIN JA 1992
DA7416	Discovery 1	200Tdi	RHD	From VIN JA 1993
DA7417	Discovery 1	300Tdi	RHD	From 1994 non-ABS
DA7433	Discovery 1	300Tdi	LHD	From 1994 with ABS
DA7422	Range Rover Classic		RHD	Early models
DA7421	Range Rover Classic		RHD	From 1979 with rear valve
DA7434	Range Rover Classic		LHD	From 1979 with rear valve
DA7423	Range Rover Classic		RHD	Non-ABS from 1987 VIN DA274121 (2-door) & DA273923 (4-door) OSF valve
DA7424	Range Rover Classic		RHD	ABS 1986 up to VIN CA274120 (2-door) & CA273922 (4-door) front valve & bypass pipe
DA7435	Range Rover Classic		LHD	From 1987 non-ABS from VIN DA274121 (2-door) & DA273923 (4-door) front valve & bypass pipe
DA7436	Range Rover Classic		LHD	ABS front valve & bypass pipe 1986. 1983 up to VIN CA274120 (2-door) & CA273922 (4-door) 1986 onwards
DA7425	Range Rover Classic		RHD	ABS 1990 - 1991 VIN HA
DA7426	Range Rover Classic		RHD	ABS 1992 VIN JA
DA7427	Range Rover Classic		RHD	1993 VIN KA air suspension
DA7437	Range Rover Classic		LHD	Up to 1992 VIN HA with Clayton Dewandre Wabco 4-channel ABS

Anti-squeal Shims



DA1141

Universal self adhesive noise dampening shims. Pack of 4.

The shims are manufactured from wolverine and cut to shape and applied to the backing plate of the brake pads prior to fitting to help eliminate any noise issues (should the pad be unshimmed). When used in conjunction with Mintex Cera-Tec silicon based lubricant, most brake noise related issues will be eradicated.

Brake Fitting Kit

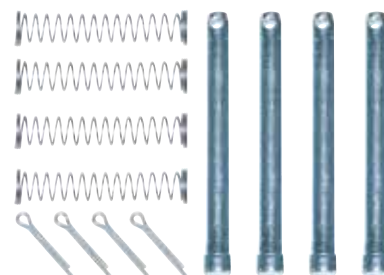

DA4105

Defender - 1987 - 2006
Brake fitting kit for rear brake pads STC1601 & SFP000280

Parking Brake Spring Kits



LR031947KIT

LR031947KIT

Discovery 4
Range Rover Sport - 2010 - 2013
SFS500012KIT
Discovery 3/Discovery 4
Range Rover Sport - 2005 - 2013

Britpart XD & XS Brake Pads

XD Brake Pads **XS Brake Pads**

Defender			
STC2952	STC2952G	1987 - 2006	Front
SFP000260	SFP000260G	1987 - 2006 & 2007 -	Front
SFP000280	SFP000280G	1987 - 2006	Rear
STC1601	STC1601G	1987 - 2006	Rear
SFP000250	SFP000250G	1987 - 2006 & 2007 -	Rear
SFP000270	SFP000270G	1987 - 2006 & 2007 -	Rear
LR032954	LR032954G	2007 -	Rear
Discovery 1			
SFP500180	SFP500180G		Front
STC9190	STC9190G		Front
SFP500160	SFP500160G		Front
SFP500190	SFP500190G		Rear
SFP500200	SFP500200G		Rear
STC9189	STC9189G		Rear
Discovery 2			
SFP500150	SFP500150G		Front
SFP500130	SFP500130G		Rear
Discovery 3			
SFP500010	SFP500010G		Front
LR019618	LR019618G		Front
LR019627	LR019627G		Rear
LR055454	LR055454G		Rear
Discovery 4			
SFP500010	SFP500010G		Front
LR019618	LR019618G		Front
LR021253	LR021253G		Front
LR051626	LR051626G		Front
LR021316	LR021316G		Rear
LR019627	LR019627G		Rear
LR055454	LR055454G		Rear
LR015519	LR015519G		Rear
LR055455	LR055455G		Rear
Discovery Sport			
LR072681	LR072681G		Front
LR061385	LR061385G		Rear
Freelander 1			
SFP100360	SFP100360G		Front
LR021899	LR021899G		Front
Freelander 2			
LR004936	LR004936G		Front
LR003657	LR003657G		Rear
LR023888	LR023888G		Rear
LR043285	LR043285G		Rear
Range Rover Classic			
SFP500180	SFP500180G	1986 - 1994	Front
SFP500200	SFP500200G	1986 - 1994	Rear
Range Rover P38			
SFP500120	SFP500120G	1994 - 2001	Front
SFP500130	SFP500130G	1994 - 2001	Rear

XD Brake Pads **XS Brake Pads**

Range Rover L322			
SFC500080	SFC500080G	2002 - 2009	Front
SFP500010	SFP500010G	2002 - 2009	Front
LR019618	LR019618G	2002 - 2009	Front
SFP500070	SFP500070G	2002 - 2009	Front
SFP500210	SFP500210G	2002 - 2009	Rear
LR019627	LR019627G	2002 - 2009	Rear
LR055454	LR055454G	2002 - 2009	Rear
LR026221	LR026221G	2010 - 2012	Front
LR020362	LR020362G	2010 - 2012	Front
LR083935	LR083935G	2010 - 2012	Front
LR064181	LR064181G	2010 - 2012	Front
LR025739	LR025739G	2010 - 2012	Rear
LR015519	LR015519G	2010 - 2012	Rear
LR032903	LR032903G	2010 - 2012	Rear
Range Rover L405			
LR020362	LR020362G	2013 -	Front
LR083935	LR083935G	2013 -	Front
LR064181	LR064181G	2013 -	Front
LR036574	LR036574G	2013 -	Rear
LR079910	LR079910G	2013 -	Rear
LR079935	LR079935G	2014 -	Rear
Range Rover Sport			
SFP500010	SFP500010G	2005 - 2009	Front
LR019618	LR019618G	2005 - 2009	Front
SFP500070	SFP500070G	2005 - 2009	Front
LR019627	LR019627G	2005 - 2009	Rear
LR055454	LR055454G	2005 - 2009	Rear
LR021253	LR021253G	2010 - 2013	Front
LR020362	LR020362G	2010 - 2013 & 2014 -	Front
LR083935	LR083935G	2013 -	Front
LR064181	LR064181G	2010 - 2013 & 2014 -	Front
LR051626	LR051626G	2010 - 2013 & 2014 -	Front
LR019627	LR019627G	2010 - 2013	Rear
LR055454	LR055454G	2010 - 2013	Rear
LR025739	LR025739G	2010 - 2013	Rear
LR015519	LR015519G	2010 - 2013	Rear
LR055455	LR055455G	2010 - 2013	Rear
LR036574	LR036574G	2014 -	Rear
LR079910	LR079910G	2014 -	Rear
LR079935	LR079935G	2014 -	Rear
Range Rover Evoque			
LR027309	LR027309G		Front
LR072681	LR072681G	GH onwards	Front
LR061385	LR061385G	GH onwards	Rear
LR027129	LR027129G		Rear
LR043714	LR043714G		Rear

IMPORTANT BRAKE INFORMATION For exact change over points with vehicle applications please contact your local Britpart distributor with the full chassis number for the correct application. These references are intended as a guide only.

XD Brake Pads



- > Manufactured to OEM specifications ensuring long life and low noise in a TS16949 & ISO14021 approved factory.
- > Asbestos, lead & CR6 free material.
- > The XD Brake Pad range meet all official legislation for quality and safety and are compliant with European ECE R90.
- > All XD Brake Pads are produced with an underlayer material designed to dampen vibrations to prevent noise and to reduce heat transfer to the brake fluid.

The Britpart range of XD Brake Pads gives you the opportunity of fitting a much higher quality brake pad than the price would indicate. Britpart has tested many different brake pads over the last 5 years and have found this brake pad specification offers Land Rover owners the best possible performance at this price level.

The XD Brake Pads are manufactured to an exact tolerance using only the best European friction materials to OEM specifications ensuring long life and low noise. All raw materials are analysed in-house using a fully equipped quality laboratory with, for example, an atomic absorption device. After analysis the raw materials are mixed and pressed using several different methods to achieve the best brake pad for each application. Each part number is tailored to the application it is intended for. The XD Brake Pad range has been thoroughly tested on dynamometers and noise measuring rigs before being put through their paces on test tracks and extended operations tests to ensure a perfect and effective operation every time. All pads are covered by the worldwide Britpart warranty and Britpart recommends they are fitted with the Britpart standard or performance brake discs.

XS Brake Pads



Best possible combination of long life, pedal feel and noise suppression.

The exact performance material specification of production line brake pads.

The Britpart range of XS Brake Pads offers you the opportunity to have the exact factory production line specification of brake pad at an affordable price. These pads offer the best possible combination of long life, pedal feel and noise suppression. All the pads in the range use the same friction material specification that your Land Rover was originally made with. The XS range of pads are all produced in one of the world's premium brake pad facilities where production procedures are carefully monitored to ensure a consistently good product. The facility has both in-house testing and access to OE testing facilities to ensure all pads meet the exact specification required. Britpart XS Brake Pads are ideal for high mileage or heavy-duty applications.



XS Brake Discs



XS Brake Disc

- > Exact OEM specification.
- > Low noise.
- > Installation ready - no need for cleaning before use.
- > Anti-corrosion coating which provides a long lasting clean appearance, ideal for today's open rims.
- > Disc run out - $\leq 0.08\text{mm}$
- > Unbalance requirement - $\leq 150\text{g.cm}$
- > Coating - 5*20µm NA paint
- > Salt spray test - 120 hours



Model	Year Range	Position	Type
Defender			
LR017951G / FRC7329G	1987 - 2006 & 2007 onwards	Front	Solid
LR017952G / FTC902G	1987 - 2006 & 2007 onwards	Front	Vented
FTC3846G	1987 - 2006	Rear	Solid
LR017953G / FTC1381G	1987 - 2006 & 2007 onwards	Rear	Solid
LR018026G / SDB000330G	1987 - 2006 & 2007 onwards	Rear	Solid
Discovery 1			
LR017951G / FRC7329G		Front	Solid
LR017952G / FTC902G		Front	Vented
LR017953G / FTC1381G		Rear	Solid
Discovery 2			
SDB000380G		Front	Vented
SDB000470G		Rear	Solid
Discovery 3			
SDB000614G		Front	Vented
SDB000604G		Front	Vented
SDB000646G		Rear	Vented
SDB000636G		Rear	Vented
Discovery 4			
SDB000624G		Front	Vented
SDB000604G		Front	Vented
LR025946G		Front	Vented
SDB000646G		Rear	Vented
SDB000636G		Rear	Vented
Discovery Sport			
LR059122G		Front	Vented
LR007055G		Front	Vented
LR061388G		Rear	Solid
Freelander 1			
SDB100830G	Up to YA999999	Front	Solid
SDB101070G	1A000001 onwards	Front	Vented
Freelander 2			
LR000470G / LR027107G	Petrol	Front	Vented
LR001019G	Petrol	Rear	Vented
LR007055G	Diesel	Front	Vented
LR001018G	Diesel	Rear	Solid
LR039935G	From DH000001	Rear	Solid
Range Rover Classic			
LR017951G / FRC7329G	1986 - 1991	Front	Solid
LR017952G / FTC902G	1986 - 1994	Front	Vented
LR017953G / FTC1381G	1986 - 1994	Rear	Solid
Range Rover P38			
NTC8780G	1995 - 2002	Front	Vented
SDB000470G	1995 - 2002	Rear	Solid
Range Rover Sport			
SDB000614G	2005 - 2009	Front	Vented
SDB000604G	2005 - 2009	Front	Vented
SDB000624G	2005 - 2013	Front	Vented
LR025946G	2010 - 2013	Front	Vented
SDB000646G	2005 - 2013	Rear	Vented
SDB000636G	2005 - 2009	Rear	Vented
LR016192G	2010 - 2013	Rear	Vented
LR016176G	2014 onwards	Front	Vented
LR038934G	2014 onwards	Front	Vented
LR033303G	2014 onwards	Rear	Vented
LR033302G	2014 onwards	Rear	Vented
Range Rover L322			
SDB000201G		Front	Vented
SDB500182G		Front	Vented
LR031843G / SDB500193G		Front	Vented
LR031845G		Front	Vented
SDB000211G		Rear	Solid
LR031844G / SDB500202G		Rear	Vented
LR016176G	2010 - 2012	Front	Vented
LR031846G	2010 - 2012	Rear	Vented
Range Rover L405			
LR016176G		Front	Vented
LR038934G		Front	Vented
LR033303G		Rear	Vented
LR033302G		Rear	Vented
Range Rover Evoque			
LR007055G		Front	Vented
LR027123G		Rear	Solid
LR059122G	17" wheel	Front	Vented

Brake Lubrication

DA2389

- 75ml
Cera-Tec Advanced Lubricant
Mintex Cera-Tec is an advanced non-metallic universal lubricant that provides many benefits over traditional copper-based grease.
- > Non-metallic content
 - ABS and ESP friendly.
 - > Operates to a high temperature (1,000°C).
 - > Non-conductive.
 - > Free of copper and acid.
 - > More effective at reducing any brake squeal.
 - > Protects against corrosion and dirt.
 - > Neutral colour prevents any visible residue or staining.



Stainless Steel Brake Calliper Pistons & Kits

Stainless steel brake calliper piston kits

Each kit is one complete axle, either front or rear as stated.
The kit includes OEM repair kit and grease sachet.

DA1165	Defender - up to HA701009/Discovery 1/Range Rover Classic	Front
DA1166	Defender - HA701010 onwards	Front
DA1167	Defender - 90/Discovery 1/ Range Rover Classic	Rear
DA1172	Defender - 110/130	Rear
Single stainless steel pistons		
606683S	Defender - up to HA701009/ Discovery 1/Range Rover Classic	Front
606696S	Defender - 90/Discovery 1/Range Rover Classic	Rear
STC201S	Defender - HA701010 onwards	Front
	Defender - 110/130	Rear



Electrics

Alternator Upgrade Kits

DA1195



200Tdi alternator upgrade kits. Kits include uprated cable.

DA1195 Defender - 200Tdi
Upgrade the 45A alternator to 100A

DA1196 Discovery 1 - 200Tdi
Upgrade the alternator to 100A

Electronic Distributors NEW



ETC5835ERED NEW Red top
ETC5835EBLACK NEW Black top
Defender - 90/110 - 2.5l 4-cyl petrol - 1985 - 1994
Distributor with electronic conversion fitted which replaces the existing points and condenser with a new reliable electronic module.

Electronic Conversion Kits

ETC5835K
Electronic conversion kit replaces the existing points and condenser with a new reliable electronic module. For 4-cylinder petrol engines the electronic ignition module has been developed to work with the standard ignition coil and provides service free and accurate ignition timing. The kit can be easily fitted to standard points type 45D4 distributors. We recommend fitting a new coil at the same time - PRC9858. Also available a new distributor with points to which this kit can be fitted - ETC5835.

ERC4536K
This electronic conversion kit is for V8 points and has built in dwell adjustment with rpm protection when not running.



Ignition Lead Sets

Defender - 4.0 V8
Range Rover P38 - V8 - up to 1999
DA4102 Grey leads
DA4102RED Red leads

Discovery 1 - V8
Range Rover Classic - V8
Note - Includes king lead
DA4104 Grey leads
DA4104RED Red leads
Discovery 1 - V8 / Range Rover Classic - V8
STC9124 Grey lead

King lead with protective & waterproof rubber coil cover
Defender - 3.5 V8
Discovery 1 - 3.5 V8 carb & 3.5 V8 Efi
Range Rover Classic - 3.5 V8 carb
Range Rover Classic - 3.5 V8 Efi

RTC6551 Grey leads
RTC6551RED Red leads

Note - Includes king lead
Range Rover P38
Discovery 2 - 1999 onwards
NGC103740/810 Grey leads
NGC103740/810RED Red leads
DA5684 Red leads
Range Rover P38 - 4.6V8 1994 - 1998
NGC500370/410 Grey leads
Freelander 1 - 1.8K



These silicone HT lead sets are designed to meet or exceed the original equipment specification. The silicone cable has minimal interference with maximum suppression, it is also resistant to water, oils, chemicals and high temperatures. High quality with ISO 3808 class noise suppression performance.



Windscreen Wiper Motors NEW

AMR3869M



AMR3869M NEW Discovery 1 Right hand drive
AMR1515M NEW Discovery 1 Left hand drive
DLB101770M NEW Range Rover P38 Left hand drive

Ignition Module & Link Lead

STC1184K
Module for V8 distributor
Kit to convert 3-pin to 2-pin applications



Powerlite Starter Motors & Dynalite Alternator NEW

Starter Motors
NAD10040HD NEW Defender - 2½ petrol 4-cylinder
NAD101490HD NEW Defender - V8/Discovery 1 - V8
Discovery 2 - V8
Range Rover P38 - V8 - 1994-2001
RTC5225HD NEW Series 3 - 2¼ petrol
RTC5232HD NEW Series 3 - 2¼ diesel
Alternator
RTC3840A NEW Series 2 & 2A - 2¼ litre 4-cylinder

More information in Performance section and images online



Programmable Wiper Relay

AMR2341DELAY
Fed up with your Defender's intermittent wipers not being intermittent enough? Does it drive you mad when you give the screen a quick spray and it wipes for ages?



Fit this new relay in place of the standard AMR2341 to your vehicle to solve this problem. Once fitted you press the stalk down so that the wiper wipes and then back off again, now count/wait till you want another wipe, switch the stalk down and leave it on, this timing will now remain constant till you set another timing the same way or turn off the ignition at which point the relay reverts to a standard 6 second wipe interval. Another bonus is that the wipers will now only wipe once following a short burst of washer fluid or 3 times after a long burst. This will work on all Defenders with the latching intermittent wiper stalk PRC7370 or AMR6106 HA onwards (stays down when pressed) but it will also work on 300Tdi and Td5 although on post 2002 Td5s the relay AMR2341 is located behind the speedo. Will not work with early stalk PRC3900 up to GA models.

Engine



AEU2147LX

Cylinder Heads

Complete 300Tdi cylinder heads. Supplied with valves and head bolts, pressure tested and with heat tell tale stickers on.



ERR5027COM

LDF500180COM

LDF500180COM

Note - This head has additional waterways for improved cooling. Use multi-leaf metal head gasket (LVB500220 - 3-hole) with this head.

Bulk Filters

ESR4238X	Defender - 1987 - 2006 Discovery 2 - 1998 - 2004/Freelander 1 Range Rover P38	Qty 50 Air filters
AEU2147LX	Defender/Discovery 1 Range Rover Classic - 1986 - 1994	Qty 50 Fuel filters
ESR4686X	Defender/Discovery 2	Qty 50 Fuel filters
ERR3340X	Defender/Discovery 1/Discovery 2 Range Rover Classic/Range Rover P38	Qty 50 Oil filters
JKR500020X	Discovery 3/Discovery 4 Range Rover Sport - 2005 - 2013	Qty 50 Pollen filters- odour & particles
ERR6299X	Defender/Discovery 2	Qty 50 Rotor filters

Injector Pipe Sets

Set of 4 injector pipes per kit
563165/6/7/8
Series - 2.25 diesel Defender - 2.25 diesel
ETC4291/2/3/4
Defender 2.5 diesel & 2.5 diesel turbo
STC793/4/5/6
Defender - 200Tdi
RTC6732/3/4/5
Discovery 1 Range Rover Classic - 200Tdi
STC1694/5/6/7
Defender - 300Tdi - Less EDC Discovery 1 - 300Tdi - Less EDC Range Rover Classic - 300Tdi - Less EDC

STC1964/5/6/7



Cylinder Liner Kit



LCJ000050LKIT
Liner and piston for 1.8 litre K-series engines.

Main Bearing Sets



DA5121	Defender - 2.4 Puma Standard size set
DA5121AE	Standard size Glyco brand set
DA5121025AE	0.25mm size Glyco brand set
DA5121050AE	0.50mm size Glyco brand set
DA5714	Discovery 3 - 2.7 TdV6 Range Rover Sport - 2.7 TdV6 Undersize 0.5mm main bearing set and big ends
DA5120	Standard size set Freelander 1 - K-Series 1.8 engine

Gaskets & Head Bolt Sets

Head & Bottom Gasket Sets

DA2112	Td5	Head set	No head gasket
DA2112-1	Td5	Head set	1-hole gasket
DA2112-2	Td5	Head set	2-hole gasket
DA2112-3	Td5	Head set	3-hole gasket
DA2113	Td5	Bottom set	
DA2112G-EARLY	Defender - up to 1A622423 & Discovery 2 - up to 1A736339	Elring head set	No head gasket
DA2112G-LATER	Defender - 1A622424 onwards & Discovery 2 - 2A736340 onwards	Elring head set	No head gasket
DA2508	Defender - Puma 2.4	Head set	No head gasket
DA2518	Defender - Puma 2.2	Head set	No head gasket
DA2114	Freelander 1 - 1.8 16v	Head set	Inc. head gasket
DA2115	Freelander 1 - 1.8 16v	Bottom set	
DA3143	Freelander 1 - 2.5KV6	Head set	Inc. head gasket
DA3145	Freelander 1 - 2.0 diesel L series	Head set	No head gasket
DA5132 NEW	Discovery 3 - 2.7TdV6	Head set	No head gasket
DA5129 NEW	Range Rover Sport - 2.7TdV6	Head set	No head gasket
	Discovery 3 - 2.7TdV6	Bottom set	
	Range Rover Sport - 2.7TdV6	Bottom set	

Head Gasket Kits & Head Bolt Sets

STC1172B	200Tdi	No head gasket
STC2802B	300Tdi	No head gasket
DA2112B	Td5	No head gasket
DA2114B	Freelander 1 - 1.8 16v	Inc. head gasket
Cam Cover Gasket Set DA5128	2.2 diesel cam cover gasket set	Freelander 2 Discovery Sport Range Rover Evoque

Head Bolt Sets

DA2006	200Tdi engines
DA2005	300Tdi engines
DA3356	1.8K Series engines
DA3357	2.0l Tcic engines
DA3367	TdV6 engines
DA3368	TdV8 engines
DA2505	Defender - Puma 2.4
DA2506	Defender - Puma 2.2
DA2141	4.0/4.6 V8 ten bolt heads 2.2 diesel engines Freelander 2 Discovery Sport Range Rover Evoque
DA3369	

Many more images available online at www.britpart.com

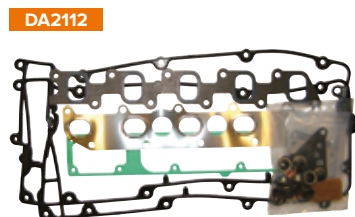

DA2112



DA2112G-LATER



STC1172B



DA2114B



DA5132

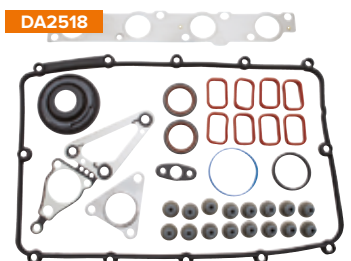

DA2518



DA3357



DA3369

Engines

Complete Engines

Include fuel pump, injectors, injector pipes, timing assembly and bell housing. Complete engines are tested prior to despatch. Once tested the flywheel and manifolds are removed and the engine is packed without these parts. Outer timing covers, pulleys, manifolds, flywheel and turbo charger are not included.

Stripped Engines

Include sump, block, cylinder head, rocker cover, inner timing cover, camshaft and crankshaft gear.

Engines - New

DA1183	Defender - 2.2 Puma	Stripped
DA1182	Defender - 2.4 Puma	Stripped
DA2039	Freelander 1 - 1.8K	Complete

Engines - Reconditioned

DA4250DIS	Discovery 1 - 200Tdi	Complete
-----------	----------------------	----------

DA1183



DA4250DIS



Timing Chain Kit **NEW**



DA1337 NEW
Timing chain kit - 2.25 petrol
Series 2/Series 2A/Series 3 - up to 1974

Td5 Short Oil Filter



Save time & effort with this easier to fit filter

LPX100590XD
Td5 oil filter. Shorter than the standard filter which makes this one much easier to fit and remove.

Heater Plug Upgrade Kit



DA1057
Series - 2.25 diesel engine
DA1057PLUG
Replacement heater plug set for DA1057



Fuel Filter Holder



DA1159
Defender - 2007 onwards
Replacement fuel filter holder

Oil Pump Gear Set



DA4189
Discovery 1/Discovery 2/Range Rover P38
Oil pump gear set for V8 engines

Manifold Inlet Seal



LR0044045
Defender - Puma
Manifold inlet seal. This is not available as a separate part from Land Rover.

Pressure Relief Valve



DA2376
300Tdi oil pump relief valve kit for Defender
Discovery 1
Range Rover Classic

Oil Cooler Repair Kit



DA1127
Td5 oil cooler repair kit, to replace leaking oil cooler found in all Td5 engines, part of the PBC500230 assembly. Replace just the faulty cooler and not the casting which normally is perfectly serviceable, includes all hardware required. All manufactured to exact OEM specification.

Top Hat Liner Set



DA1185
This flanged repair liner is suitable for damaged/porous 3.9/4.0/4.2/4.6 Rover V8 blocks. The block will require re-boring and flange recess machining before fitting. This liner is the complete solution for fixing these blocks. The liner can be bored to 96.00mm for over-bored versions of the V8 engine, taking it to 5.0 litres. Semi finished bore 94.00mm (less 1.00mm for final finishing in bore).
Dimensions
Inside diameter - 94.00mm; outside diameter - 99.06mm; length - 135.64mm; flange - diameter - 105.23mm; flange depth - 5.33mm

Timing Belt Kits

DA1200DEF	Defender - 200Tdi	
DA1200DEFG	Defender - 200Tdi	OEM tensioner
DA1200DIS	Discovery 1/Range Rover Classic - 200Tdi	
DA1200DISG	Discovery 1/Range Rover Classic - 200Tdi	OEM tensioner
DA1300	300Tdi engines	
DA1300G	300Tdi engines	OEM kit
DA1264G	Defender 2.5D & 2.5TD	OEM kit
DA1261G	Freelander 1 - 1.8	Manual tension
DA1265G	Freelander 1 - 1.8	Automatic tension
DA1262G	Freelander 1 - 2.0Tcie	114 teeth
DA1263G	Freelander 1 - 2.0Tcie	112 teeth

DA1200DEFG



DA1300G



Injector Washer Kits

Td5 injector washer kits with O-rings and washers

DA2479LR
Genuine set
DA2479G
OEM set
DA2479
Britpart set

DA2479G



Pistons & Ring Sets **NEW**



Defender 2.2Tdc
DA5133 NEW
 Piston fitted with ring set
DA5134 NEW
 Piston ring set

Aluminium Rockers

602153A



602154A

602153A
602154A
 Defender - 1987 - 2006
 Discovery 1
 Discovery 2
 Range Rover Classic - 1986 - 1994
 Range Rover P38 - 1994 - 2001

Water Sensor Repair Kit



LR045519REPAIRKIT
 Discovery 4
 Range Rover Sport - 2010 - 2013

XS Water Pumps

LR013164



PEB500090G



LR004799G Defender - 2007 onwards
LR013164 Discovery 4
 Range Rover Sport - 2010 - 2013 & 2014 onwards
 Range Rover L405

PEB102240LG Freelander 1
PEB102420LG Discovery 1/Freelander 1
PEB500090G Defender - 1987 - 2006/Discovery 1
 Range Rover Classic - 1992 - 1994

PEM500040G Defender - Td5/Discovery 2 - Td5
 Defender - 1987 - 2006

STC483G Discovery 1
 Range Rover Classic - 1992 - 1994

STC637G Defender - 1987 - 2006

STC3758G Series 2A/Series 3 - 2.25l - 9-stud
 Defender - 1987 - 2006 - 4.0 V8/Discovery 1 - 4.0 V8
 Discovery 2 - 4.0 V8/Range Rover P38 - 4.0 V8

STC4378G



Radiator Hose Kit



DA1336
Series 2, 2A & 3
Radiator hose kit

Manifold Link **NEW**



1357035 NEW
Manifold link pipe including heat resistant sleeve for 2.7 V6 diesel engines
Discovery 3
Discovery 4
Range Rover Sport - 2005 - 2009

Cylinder Head Overhaul Kits

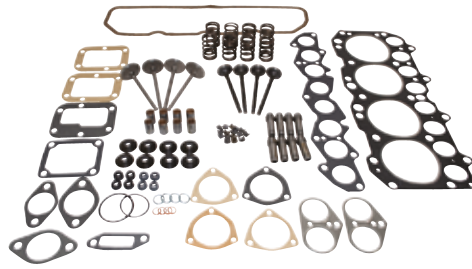

DA1338
Series 2 & 2A - petrol
Series 3 - up to 1974 - petrol

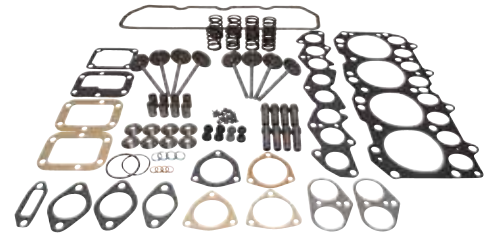

DA1339 Series 3 - 1974 onwards - petrol



DA1340
Series 2 & 2A - diesel
Series 3 - up to 1974 - diesel



DA1341 Series 3 - 1974 onwards - diesel

TdV6 Engine Parts



DA6621



DA6624



DA6626

DA6628

DA6627

Con Rod Bearing Sets	
DA6620 NEW Standard	2.7 & 3.0 engines
DA6621 NEW 010"	2.7 & 3.0 engines
DA6622 NEW 020"	2.7 & 3.0 engines
Main Bearing Sets	
DA6623 NEW Standard	2.7 & 3.0 engines
DA6624 NEW 010"	2.7 & 3.0 engines
DA6625 NEW 020"	2.7 & 3.0 engines
DA6626 Con rod assembly	2.7 & 3.0 engines
DA6627 Con rod bolt	2.7 & 3.0 engines
DA6628 Con rod bush	2.7 & 3.0 engines
DA7300 NEW Crankshaft	2.7 engines
DA5127 Individual standard piston fitted with ring set	2.7 engines
DA5127020 NEW Individual 020" piston fitted with ring set	2.7 engines
DA5126 Piston ring set	2.7 engines



DA7300



DA5127



Photo courtesy of Jundio Salvador

Manifold Assembly Fuel Sensor



1387695SENSOR NEW
Replace the sensor rather than the whole fuel rail.
Discovery 3
Range Rover Sport - 2005 - 2009

Exhaust Fitting Kits



DA1293

All you need to replace the exhaust on a Series - SWB.
DA1293 Right hand drive
DA1294 Left hand drive

Td5 Oil Pump



LPF500020
High quality, cost effective replacement oil pump for Td5 engines.

Engine Bay Enhancements



ERR4686BLUE

Filler Plugs
ERR4686BLUE Blue
ERR4686RED Red
 Replace your existing filler plug with one of these smart anodised aluminium ones. Suitable for use on a Defender, Discovery 1 & Range Rover Classic on the radiator and thermostat housing. Can also be used on the diff filler level on a Discovery 2.

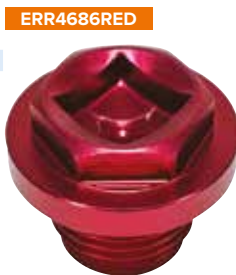

ERR4686RED



DA8896

Expansion Bottle Cap
DA8896
 Defender - Td5 onwards
 Freelander 1
 Smart anodised aluminium direct replacement expansion bottle cap - PCD100160. Will not fit on aluminium header tank - DA4751.



DA8891

Oil Filler Cap
DA8891 NEW
 Defender Tdci
 Anodised aluminium. Includes rubber seal



DA8890

Oil Filler Cap
DA8890 NEW
 Defender - Td5
 Anodised aluminium. Includes rubber seal



DA8894

Power Steering Reservoir Cap
 Defender
 Anodised aluminium. Includes rubber seal.
DA8895 NEW Standard
DA8894 NEW With cooling fins for extreme off-road and racing conditions



DA8894



DA8895

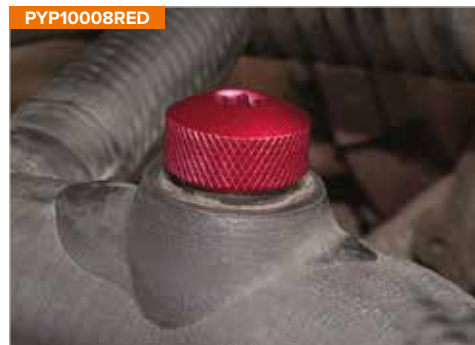

PYP10008RED

Bleed Screws
 Smart replacement anodised aluminium bleed screws for the top hose on a Td5 engine.

PYP10008BLUE Blue
PYP10008RED Red



PYP10008BLUE



Photo courtesy of LRO Magazine

Heating

DA4178

Range Rover Classic - 1990 - 1994 - 200Tdi with air con
Discovery 1 - 200Tdi with air con

Atlantic British has developed this all inclusive kit designed and engineered to replace failed heater motors. The kit includes heater blower motor, blower wheel, motor mounting bracket and mounting screws, heater assembly seals, nylon ties, solder, shrink tubing (for soldered connections) and complete instructions. **Note** - When replacing the heater blower motor the vehicle's resistor must be upgraded to DA4178RESISTOR.

DA4178RESISTOR

The air con blower motor resistor controls the speed of the blower motor and the force of the airflow out of the dash vents, it features a thermal-sink aluminium mounting plate that dissipates circuit heat effectively.

Heater Matrixes

DA2155 Series 3

AAP817 Defender - downward facing pipes

UTP1725 Defender - horizontal inlet/outlet pipes

JEF100220 Defender - LHD - XA159807 onwards

STC250 Discovery 1/Range Rover Classic - 1986 - 1994

STC3135 Discovery 1/Range Rover Classic - 1992 - 1994

JEF100150 Freelander 1 - up to YA999999

STC3261 Range Rover P38

More images online at www.britpart.com

Heater Blower Motor Kit & Resistor Kit

DA4178



DA4178RESISTOR



DA2155



UTP1725



Valve Unit

JQD500080V

Defender -
2007 onwards
Valve unit from
JQD500080
No bracket



Transmission

Diff Repair Pans

DA1043



DA1044



DA1045



DA1043 Front - includes filler plug
Defender/Discovery 1/Range Rover Classic/Series

DA1044 Rear - includes filler plug
Defender 90/Discovery 1/Range Rover Classic/Series

DA1045 Front & rear - excludes filler plug
Series - early models

Automatic Transmission Filter Conversion & Service Kits

Degradation in oil can lead to judder, noise and a deterioration in gear change quality. ZF recommend oil and filter changes after 50,000 to 75,000 miles on automatic gearboxes to ensure optimum performance.

This is an easy change filter conversion kit for all vehicles using the ZF 6HP26 automatic transmission - Discovery 3, Discovery 4, Range Rover Sport - 2005 - 2013 and Range Rover L322 models. From the factory a fluid and filter change on this transmission is a very lengthy process. The sump and filter are normally one piece and fitting involves jacking the engine up and unbolting the mounts, plus the removal of the exhaust.

The fitting of this kit is far easier. Once the fluid has been drained from the transmission simply remove the bolts from the old unit. Cut the old plastic sumps filter tube with a hacksaw. Slide the old sump out and remove the other end of the sawn off filter tube. The new separate filter can then be fitted and the new sump pan slides into place and is bolted up with the new gasket supplied. Once secure the transmission can be filled as per manufacturer's instructions. The new sump pan also has the added benefit that it is manufactured in durable steel rather than the plastic of the original item - LR007474. Also see DA6085 & DA6085G in service kit section. 7ltrs needed for oil change.

Britpart		OEM	
DA2142	Filter conversion kit	DA2142G	Filter conversion kit - OEM
DA2143	Replacement filter	DA2143G	Replacement filter - OEM
DA2144	Replacement gasket	DA2144G	Replacement gasket - OEM
TYK500050	Ravenol fluid - 1 litre	TYK500050G	ZF Lifeguard fluid - 1 litre

DA2142G



DA4500

Defender - up to 2007/Discovery 1
Discovery 2/Range Rover Classic
Range Rover P38 Service kit for 4-speed gearbox.
Kit comprises of oil screen, seals, o-rings and sealing washer.

DA1113

Range Rover L322 - 4.4 V8
Service kit for 5-speed gearbox.
Kit comprises of oil screen, seal & o-ring.

Damper Kit



DA2352

Freelander 1 - up to 2006 4-cylinder
Not all viscous coupling problems are the fault of the unit itself, sometimes the damper is at fault, this kit prevents buying the whole coupling, just to replace the damper.

Diff Coupling Shaft



We are now able to offer a cheaper alternative!

DA2355

Range Rover L322 - 2002 onwards, suffer from a common problem with the coupling shaft spline wearing between the front propshaft and front differential, thus losing drive to the differential. The problem relates to the coupling shaft, the differential itself is not affected. Currently the only solution offered by Land Rover is to replace the propshaft and the whole complete front differential assembly - a very expensive option! Using this new coupling shaft will enable you to replace just the propshaft and coupling shaft and leave the differential in place, therefore reducing both time (the differential need not be removed from the vehicle) and cost.



[facebook.com/britpart](https://www.facebook.com/britpart)

CV Joint Kits

Britpart has put together these boxed kits to help the fitter have all the necessary parts to do the job in one hit, saving time and money trying to find the necessary parts to do the job. These kits are also helpful to pass over the trade counter instead of having to hunt for the individual parts. One kit does one CV joint.

- DA6050**
Range Rover Classic - up to 1985
- DA6051**
Range Rover Classic - 1986 up to 1988 non-ABS axle suffix A up to EA305589
- DA6052**
Range Rover Classic - 1989 up to 1991 non-ABS axle suffix B from EA305590 up to HA610293
- DA6053**
Range Rover Classic - 1992 on non-ABS up to JA624755
- DA6054**
Range Rover Classic - 1986 up to 1991 with ABS up to HA610293
- DA6055**
Range Rover Classic - 1992 on non-ABS from KA624756 up to P38
- DA6056**
Range Rover Classic - 1992 on with ABS up to P38
- DA6057**
Range Rover Classic - 1992 on non-ABS from KA624756 up to P38
- DA6058**
Range Rover Classic - 1992 on with ABS up to P38
- DA6059**
Range Rover P38 - 1995 up to 2002
- DA6060**
Range Rover P38 - 1995 up to 2002
- DA6061**
Defender - non-ABS with 23 internal splines
- DA6062**
Defender - 1986 on non-ABS with 32 internal splines
- DA6063**
Defender - non-ABS and ABS models from LA up to 2007



- DA6060**
Discovery 1 - non-ABS up to JA32850
- DA6061**
Discovery 1 - non-ABS JA032851 onwards
- DA6062**
Discovery 1 - non-ABS - JA032851 onwards
- DA6063**
Discovery 1 - ABS models - JA032851 onwards
- DA6064**
Discovery 2
- DA6065**
Freelander 1 - up to YA999999 TCIE diesel and 1.8 petrol

Save time & money with a Britpart CV joint kit.

Gearboxes



Gearboxes - New			
TRC103150	Defender - LT77 - 50A suffix L		
TRC102900	Freelander 1 - Petrol 1.8K16		
Gearboxes - Reconditioned			
DA3050	Defender - 4-cylinder up to 200Tdi	LT77/S	50G/H
DA3051	Defender - 200Tdi	LT77/S	56G/H
TRC103160E	Defender - 300Tdi	R380	56J
DA3058	Defender - Td5	R380	68A
LR039149	Defender - 2007 onwards		6-speed
DA3052	Discovery 1 - 200Tdi	LT77/S	55G/H
DA3054	Discovery 1 - 300Tdi	R380	55J
TRC103350E	Discovery 2 - diesel - less oil cooler		
DA3055	Range Rover P38 - diesel	R380	65J

Gearbox Bearing Kits



- DA3360** Series 3
- DA3361** Series 2A
- DA3362** LT77 suffix A - E
- DA3363** LT77 suffix F - G
- DA3364** LT77 suffix H
- DA3365** R380 suffix J
- DA3366** R380 suffix K

Gear Change Kits



- DA1252**
LT77 gearbox
Range Rover Classic - up to LA
Discovery 1 - up to LA
- DA1253**
R380 gearbox
Range Rover Classic - MA onwards
Discovery 1 - MA onwards
Discovery 2

Crown Wheel & Pinion



- TAG000230CWP**
Freelander 1
Replacement crown wheel & pinion for IRD
TAG000230.

Detent Repair Springclip



- DA6247**
Detent repair springclip to fit Discovery 3 & Discovery 4 manual gearboxes. Experiencing problems engaging reverse gear? To save expensive gearbox repairs or replacements it may just be this simple clip has broken. It is easily checked and replaced without any removal of the gearbox itself.



Propshaft Bearings

- DA2395** Discovery 3/Discovery 4 - TVB500360
 - DA2428** Range Rover L322 - TVB500400
 - DA2427** Range Rover Sport - 2005 - 2013 - TVB500390
- Centre bearing assembly for rear propshafts. Instead of replacing your whole propshaft - just replace the centre bearing!



Clutch Pedal Assist Kit



- DA1266**
Replace the old clutch pedal spring kit to assist the pressing of the clutch pedal on Defender models. This is a factory fit on later models but can be retro fitted to all 90/110 models. Consists of spring, spring retainer & spring bushes

IRD Repair Kit



- DA6440**
Freelander 1
Repair kit for intermediate reduction drive assembly (TAG000230)

Clutches

Changing your clutch?

Then demand your dealer uses a clutch kit from Britpart!

- > Extensive testing ensures the ultimate specification.
- > Premier friction material gives longer life.
- > Self centring bearing provides smooth operation.
- > Intense quality control ensures fit first time.

For many more clutch images available at www.britpart.com/clutches



Heavy-duty Clutches & Parts

DA5551	Defender/Discovery 1/Range Rover Classic - 200/300Tdi	Heavy-duty clutch kit - plate, cover & bearing
DA5551G	Defender/Discovery 1/Range Rover Classic - 200/300Tdi	OEM heavy-duty clutch kit - plate, cover & bearing
DA5551KIT	Defender/Discovery 1/Range Rover Classic - 200/300Tdi	Heavy-duty clutch kit - plate, cover, heavy-duty bearing & heavy-duty clutch fork
DA5552	Defender/Discovery 1/Range Rover Classic - 200/300Tdi	Heavy-duty clutch kit - plate, cover, less bearing
DA2357HD - Britpart	Defender/Discovery 2 - Td5	Heavy-duty clutch kit - plate, cover, heavy-duty flywheel & bearing
DA2357HDG - AP Driveline	Defender/Discovery 2 - Td5	Heavy-duty one-piece dual mass replacement flywheel designed to outlast the original. Kit also includes modified release bearing. Note - Fitting this kit will increase gearbox noise.
DA2357CP	Replacement clutch kit for DA2357HD	Heavy-duty clutch kit - plate & cover
LR072972	Defender - 2007 onwards	Up-rated clutch kit - plate & cover
PSD103470BRG	Replacement clutch release bearing for DA2357HD	Clutch release bearing - heavy-duty
FTC2957HD	Defender/Discovery 1/Range Rover Classic - various	Clutch fork - heavy-duty
FTC2957HDKIT	Defender/Discovery 1/Range Rover Classic - diesel only/non-V8	Clutch fork installation kit - heavy-duty
FTC5200HD	Defender - 1987 - 2006/Discovery 1/Discovery 2/Range Rover P38	Includes heavy-duty clutch fork, slipper pads, bush, staple & clip
		Clutch release bearing - heavy-duty



Standard Clutches & Parts

DA5550	Defender/Discovery 2 - Td5	Clutch kit - plate, cover & bearing
DA5550G	Defender/Discovery 2 - Td5	Clutch kit OEM - plate & cover less bearing
DA5550S	Defender/Discovery 2 - Td5	Clutch kit - Sachs - plate & cover less bearing
DA2357	Defender/Discovery 2 - Td5	Clutch kit - plate, cover, flywheel & bearing
DA2357G	Defender/Discovery 2 - Td5	Clutch kit - Valeo - plate, cover & flywheel
STC8358	Defender - diesel (non-Td5)/Discovery 1 - diesel/Range Rover Classic	Clutch kit - plate, cover & bearing
LR012199	Defender - 2007 onwards	Clutch kit - plate & cover
LR012199C	Defender - 2007 onwards	Clutch cover
LR012199P	Defender - 2007 onwards	Clutch plate
STC8363	Series 3	Clutch kit - plate, cover & bearing
DA2369	Series 2A	Clutch kit (9") - plate & cover
DA2370	Series 2A	Clutch kit (9 1/2") - plate & cover
EST110075/76KIT	Santana - 2.8 Anibal PS10	Clutch kit - Borg & Beck - plate, cover & bearing
URB500060	Freelander 1 - 2.0 Tc1e	Clutch kit - plate, cover & bearing
URB500060B	Freelander 1 - 2.0 Tc1e	Clutch kit - Borg & Beck - plate, cover & bearing
DA5558	Freelander 2 - 2.2 diesel	Clutch kit - plate, cover & concentric slave cylinder
LR008556	Freelander 2 - up to AH999999	Clutch kit OEM - plate & cover
DA5559	Freelander 2 - BH000001 onwards/Range Rover Evoque	Clutch kit OEM - plate, cover & concentric slave cylinder

Dual Mass Flywheel Conversion Kit

The flywheel conversion kit can be used to replace the dual mass flywheel using a solid metal flywheel and a heavy duty clutch kit. The one piece flywheel will not break up like the dual mass one so it is highly likely you will never need to change it again which means - lower cost, ease of fitting & potentially eliminating any future flywheel failures.

Note - This kit will make the gearbox more audible in the car at tick over and the kit doesn't include the release bearing - UUB000070.

DA6250	Freelander 1 - 2.0 Td4	Dual mass flywheel conversion kit - solid mass flywheel, replacement clutch cover & replacement clutch plate
DA6250G	Freelander 1 - 2.0 Td4	OEM dual mass flywheel conversion kit - solid mass flywheel, replacement clutch cover & replacement clutch plate
DA6251	Service kit for DA6250	Plate & cover



Diff Overhaul Kits

DA5035



DA5039 Front diff overhaul kit
4 bearings & 3 main oil seals
Discovery 3/ Discovery 4/
Range Rover Sport - 2005 - 2013

DA5035 Rear non-locking diff overhaul kit
6 bearings & 3 main oil seals
Discovery 3/ Discovery 4/
Range Rover Sport - 2005 - 2013

DA5038 Rear locking diff overhaul kit
5 bearings & 3 main oil seals
Discovery 3/ Discovery 4/
Range Rover Sport - 2005 - 2013

Diff Rebuild Kit



DA7211
Freelander 2
Rear diff rebuild kit
Customers may report excessive noise, either humming, a rumble or high pitched whine coming from the rear diff. This OEM kit will repair the pinion tail bearing which may cause the noise.



Double Cardan Repair Kit



DA1277
Discovery 2
Rear diff rebuild kit
Double cardan joint repair kit for Discovery 2 propshafts -
TVB000100 & TVB000220.

Rear Diff & Carrier

DA1216HD



DA1216HD
Freelander 2
Re-manufactured diff with heavy-duty input nose bearing.
DA1241
Range Rover Evoque - EH000001 onwards
Dynamic Driveline rear diff carrier to replace LR052118

Transfer Boxes

LR052756



IAB500104E Defender - Prefix 57D Td5 from 3A
LR052756 Defender - 2007 onwards

Brake & Clutch Reservoir Tank

504105G NEW
Series 2
Series 2A
Replacement combined brake and clutch reservoir serves both the brake and clutch master cylinders. An internal wall avoids a failure of both systems if one develops a leak. Reservoir is as per original design.



Auto Transmission Lever Parts

FTC4746KIT



Discovery 2
FTC4746KIT NEW FTC4746 - less lever
FTC4746BUSH NEW FTC4746 - bush only

Rear AWD Coupling Control Unit Replacement Parts

LR051320



LR073537



LR073538



LR073539



Discovery Sport
Range Rover Evoque
LR051311
Differential bracket
LR051320
Oil reservoir cover
LR073537
AWD coupling control unit
LR073538
Coupling drive shaft & pump
LR073539
Differential and carrier

LR051311



Photo courtesy of Esther Jansen

Chassis - Complete Galvanised Frames

Defender			
DA2056	Defender 90	Nat. asp./2.5 Td/200Tdi	Richards chassis
DA2056-M	Defender 90	Nat. asp./2.5 Td/200Tdi	Marsland chassis
DA2056-300TDI-M	Defender 90	300Tdi	Marsland chassis
DA2056-300TDI	Defender 90	300Tdi	Richards chassis
KVD500710	Defender 90	Td5	Richards chassis
KVD500710-M	Defender 90	Td5	Marsland chassis
DA8906	Defender 90	2007 onwards	Richards chassis
DA2057*	Defender 110	Nat. asp./2.5 Td/200Tdi	Marsland chassis
DA2057-300TDI*	Defender 110	300Tdi	Richards chassis
KVD500730	Defender 110	Td5	Richards chassis
DA8907	Defender 110	2007 onwards	Richards chassis
DA5300	Defender 90/110 - excludes 300Tdi		
	Bolt on crossmember - galvanised with fittings		

*suitable for pick-up and station wagons

Discovery

DA8900	Discovery 2 - Td5 - RHD	Up to 3A	Richards chassis
--------	-------------------------	----------	------------------

Series

NRC4642G	Series 3 - SWB - uniframe chassis		Richards chassis
NRC4356	Series 3 - 4-door LWB 4-cylinder Station Wagon		Richards chassis

Marsland Chassis

Chassis have bolt on gearbox crossmember as standard with anti-roll bar brackets front and rear. The main legs are in pressed pieces as original made from 2mm steel with 3mm stiffeners fitted and spotwelded internally for added strength where outriggers and suspension mounting points are fitted, effectively giving you 5mm of material where most needed. Bolt on rail for rear tub mountings and LH & RH steering damper bracket welded on as standard. All tapped holes re-drilled and tapped, excess galv removed with riv nuts fitted for front & rear mud flaps, power steering pipe clips and step. Rear suspension upper link bush (A-frame) fitted with new M16 bolt and sleeve to fit old level bush.

	Original Chassis	Heavy-duty Chassis
Material	Low-alloy steel, meant for stamping at a thickness of 2mm for legs. Stamping technology is well-suited for mass production, but limits the choice of materials to only malleable sheet metals of lower durability. An additional limitation is the thickness of the stamped material – for this reason certain laminated elements of the frame are particularly susceptible to corrosion.	Legs made from 3mm thick steel. Outriggers and cross members produced with 3mm, 4mm or 8mm thick material. High-durability S355 grade alloyed steel used.
Construction	Legs are welded from two stamped halves. Remaining frame elements also stamped. In order to attain adequate thickness of the material on features exposed to greater structural stress, two-part lamination was used - e.g. on the outriggers of the rear arms. This kind of bi-metal combination is particularly susceptible to corrosion.	All frame elements are laser cut and shaped with digital presses. Legs are welded from four parts. Items that require extra strength use thicker steel, not lamination. Less stress on chassis and other components due to less flex in the chassis and outriggers.
Anti-corrosion protection	Non UV stabilized paint with several mud traps.	Hot galvanization – high-quality coating which achieves a quality durable finish. Construction designed from the start for galvanization with appropriate size holes and flow ways. Additional inspection holes in the legs and other closed profiles so the chassis can be washed out internally or ideal for wax protection. Mud accumulating points kept to a minimum.

DA2056-300TDI-M

More pictures online at www.britpart.com/chassis

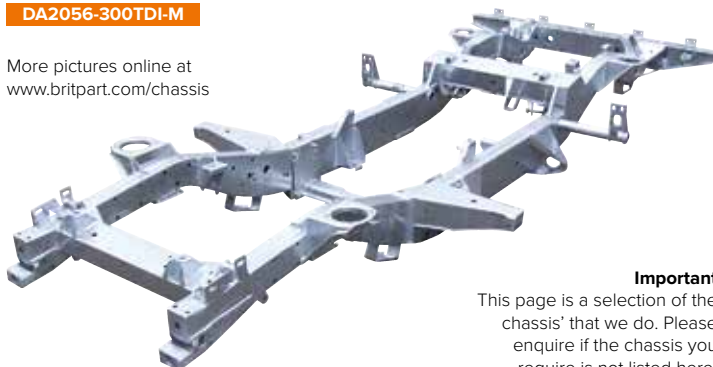

Important

This page is a selection of the chassis' that we do. Please enquire if the chassis you require is not listed here.

Richards Chassis

All Richards chassis are manufactured in the UK, using locally sourced materials and locally based machine shops. They are located close to the steel city, Sheffield, and therefore optimise the use of local steel, ensuring that all their chassis are formed from 2.5mm British steel which are all galvanised as standard. All profiling is done 'in house' using their own laser machine, enabling them to have greater control over the quality of parts used and the materials that they are formed from. The chassis are made using 2.5mm side rails which are 25% heavier than the standard 2.0mm rails. Overall this gives a small increase in the vehicle weight but has a massive effect on the long term durability of the chassis. Bolt on crossmembers are not supplied with Richards chassis but are available separately - see DA5300 above.

Heavy-Duty Chassis NEW

DA2056-300TDIHD



DA2056-300TDIHD NEW
Defender 90 - 300Tdi
DA2057-300TDIHD NEW
Defender 110 - 300Tdi

KVD500730HD

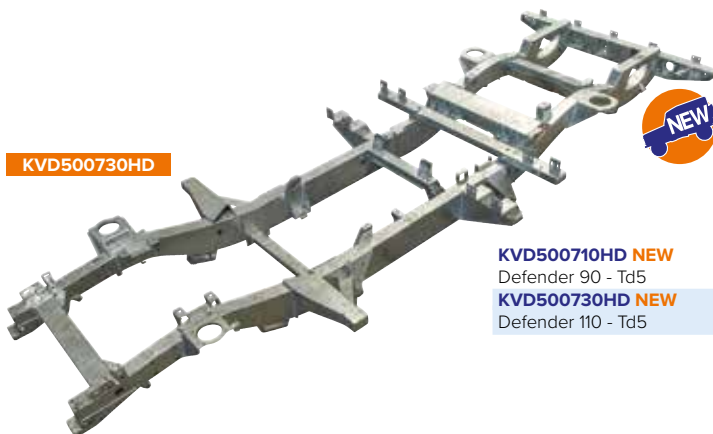

KVD500710HD NEW
Defender 90 - Td5
KVD500730HD NEW
Defender 110 - Td5



Photo, courtesy of Armando Pantarotto

Galvanised & Stainless Steel Products



Stainless Steel Products

Brake pipe swivel mount bracket. Laser cut, 2mm thick 316 grade stainless steel.

DA1394 NEW Defender - LHS

DA1395 NEW Defender - RHS

Swivel pin/mudshield bracket. Laser cut, folded, 2mm thick 316 grade stainless steel.

DA1396 NEW Defender/Discovery 1
Range Rover Classic



Galvanised Products

DA5681	Heavy-duty steel winch bumper Suitable for DB12000i, DB9500i & DB9000C winches	Defender - non air-con
DPB000270GALV	Military front bumper	Defender
RTC4769	Front bumperette - single	Defender/Series
DA1188	Front mud flap brackets - pair	Defender 90/110
DA1187	Rear mud flap brackets - pair	Defender 90
DA1186	Standard height front shock turrets with fitting kit	Defender/Discovery 1/Range Rover Classic
NRC6372GALV	Standard height front shock turret	Defender/Discovery 1/Range Rover Classic
DA1215	Rear spring seat fitting kit	Defender - 90/Discovery 1/Range Rover Classic
DA1233	Rear spring seat fitting kit	Defender - 110/130
NRC9700GALV	Spring seat - single	Defender/Discovery 1/Range Rover Classic
NRC4171GALV	Bolt-on centre crossmember	Defender Station wagon & crew cab

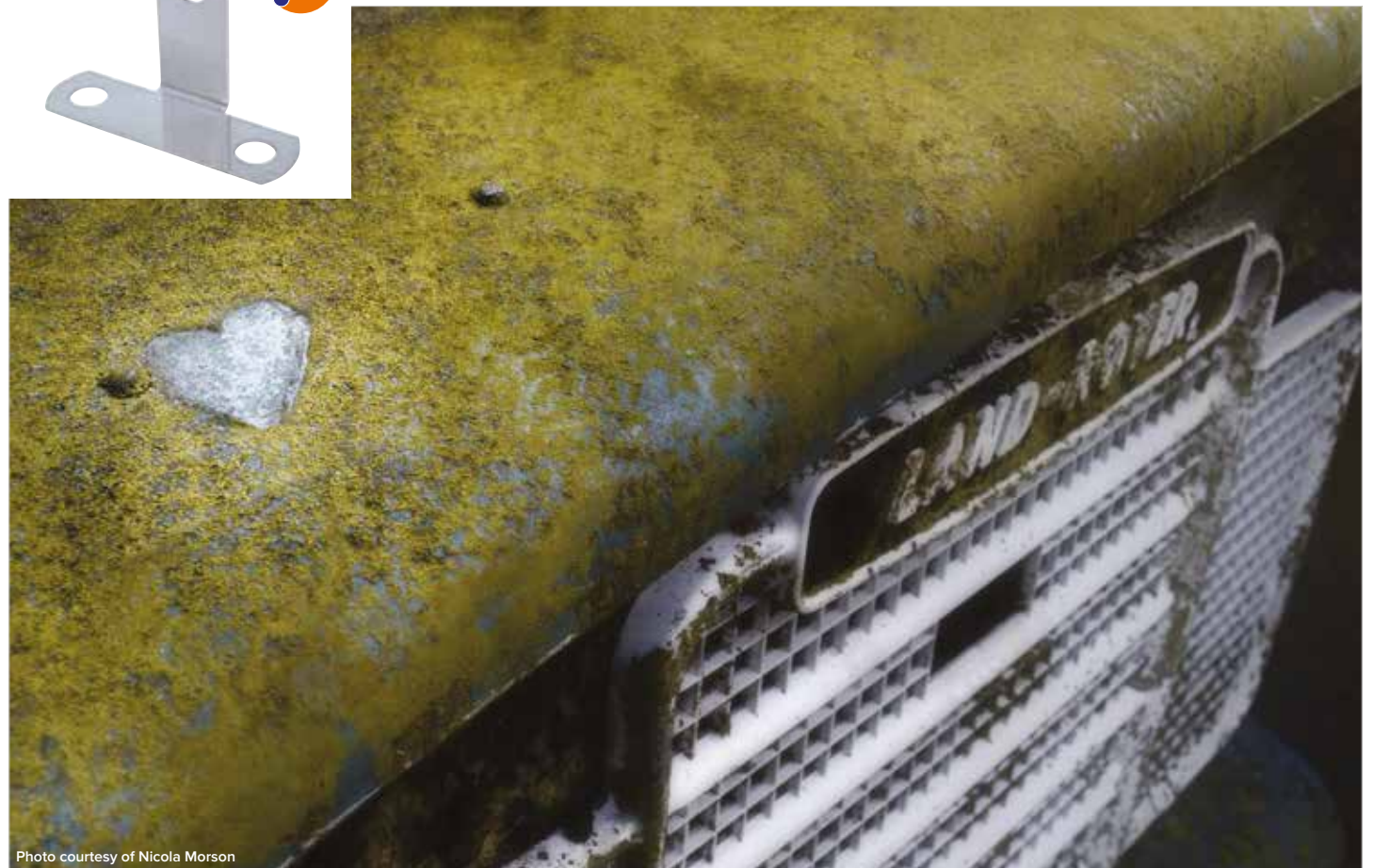

Photo courtesy of Nicola Morson

Defender - Chassis & Body Components

Bodywork - Bulkhead

DA40650	90/110	Bulkhead upper repair panel	RHS
DA4065N	90/110	Bulkhead upper repair panel	LHS
DA45970	90/110	Bulkhead repair panel with vents	RHS
DA4597N	90/110	Bulkhead repair panel with vents	LHS
DA4680	90/110	Extended bulkhead upper repair panels	Pair

Bodywork - Seats

DA4682	90/110	Seat box end panel	RHS
DA4681	90/110	Seat box end panel	LHS

Bodywork - Doors

ALR6852	90/110	Rear door - less spare wheel carrier From MA939976 up to 1A622423	
BIC710260	90/110	Rear door - 1 piece	
CQB000140	90/110	Glass for BIC710250	
LR031526	90/110	Heated glass for BIC710250	
CVW500010	90/110	Glazing rubber for BIC710250	
DA20260		Door pillar repair - bulkhead/bracket	RHS
DA2026N		Door pillar repair - bulkhead/bracket	LHS
DA2024	90/110	Safari rear door skin bottom half - up to 2006	
DA4143	90/110	Front door skin - push button handle	RHS
DA4144	90/110	Front door skin - push button handle	LHS
STC542	90/110	Front door assembly - lift handle	RHS
STC543	90/110	Front door assembly - lift handle	LHS
DA5130	110/130	2nd row door skins - up to 5A689036	RHS
DA5131	110/130	2nd row door skins - up to 5A689036	LHS
DA4142	110/130	2nd row door skins - up to 5A689036 - steel	LHS
RTC6247	90/110	Safari rear door - unglazed with spare wheel	
RTC6248	90/110	Safari rear door - glazed without spare wheel	
RTC6248NG	90/110	Safari rear door - unglazed without spare wheel	
STC1424	90/110	Rear door - less spare wheel carrier From AA242000 up to KA929577	
DA4086	90/110	Rear door bottom repair section	
DA6104	90/110	Side door bottom repair section	
DA1070	90/110	Front door hinge kit - torx head bolts kit	
DA1131	90/110	Front door hinge kit - aluminium hinges	
DA1240	90/110	Rear end door hinge kit - stainless steel fitting kit	
ALR9804	130	Rear quarter panel	RHS
ALR9803	130	Rear quarter panel	LHS
DA1355 NEW	90/110	Repair section for under the window - see web for more	

Bodywork - Floor

DA6101	90/110	Footwell - right hand drive	RHS
DA6100	90/110	Footwell - right hand drive	LHS
DA6103	90/110	Footwell - left hand drive	RHS
DA6102	90/110	Footwell - left hand drive	LHS
ALR1742	90/110	Floor panel - front - Tdi/Td5/V8	RHS
ALR1743	90/110	Floor panel - front - Tdi/Td5/V8	LHS

Bodywork - Windows

DA4032	90/110	Window kit - standard	Pair	Clear
DA4032GREY	90/110	Window kit - standard	Pair	Grey tinted
DA4033	90/110	Window kit - deluxe	Pair	Clear
DA4033GREEN	90/110	Window kit - deluxe	Pair	Green tinted
DA4033GREY	90/110	Window kit - deluxe	Pair	Grey tinted
DA4033BRONZE	90/110	Window kit - deluxe	Pair	Bronze tinted
DA4033CATCH		Replacement catch for deluxe window kit	Single	
DA4032-3SEAL		Replacement window seal for above part numbers. One seal per kit.		

Bodywork - Wings

ALR6122	90/110	Front outer wing panel	RHS
ALR6121	90/110	Front outer wing panel	LHS
ASB710260	90/110	Front outer wing panel	RHS
ASB710270	90/110	Front outer wing panel	LHS
ALR6678	90/110	Front outer wing panel	RHS
ALR6677	90/110	Front outer wing panel	LHS
RTC6351	90/110	Front outer wing panel	RHS
RTC6350	90/110	Front outer wing panel	LHS
RTC6352	90/110	Front outer wing panel	LHS
DA2523	90/110	Front nose panel	RHS
DA2522	90/110	Front nose panel	LHS
DA2524	90/110	Wing top panel	RHS
DA2525	90/110	Wing top panel	LHS

ABS plastic front outer wing panels

DA2397	90/110	Replacement for ALR6678, ASB710280 & RTC6351	RHS
DA2399	90/110	Replacement for ALR6122 & ASB710260	RHS
DA2396	90/110	Replacement for RTC6352, ALR6677 & ASB710290	LHS
DA2398	90/110	Replacement for RTC6350, ALR6121 & ASB710270	LHS

Bodywork - General

C Post repair sections are 1.2mm thick zintec coated mild steel. Machine cut and CNC pressed for accuracy. Supplied in two pieces for ease of fitting. Ready to weld in place.

DA1354 NEW	Defender 110 - Station wagon - Right hand side	RHS
DA1353 NEW	Defender 110 - Station wagon - Left hand side	LHS
DA1393 NEW	Defender - right hand drive	

Battery box. Manufactured from 2mm thick aluminium, CNC pressed and laser cut for accuracy. The battery box is supplied in 4 pieces for ease of fitting, pre-drilled to aid fitting and supplied with 50 A type rivets.

For many more body & chassis product pictures go to www.britpart.com/chassis



Chassis - Axle

STC8604	90/110	Front radius arm mount	RHS
STC8605	90/110	Front radius arm mount	LHS
STC8606	90/110	Rear radius arm mount	RHS
STC8607	90/110	Rear radius arm mount	LHS

Chassis - Bulkhead

STC8354	90/110	Bulkhead outrigger	RHS
STC8355	90/110	Bulkhead outrigger	LHS
STC8695	90/110	Tie bracket from bulkhead rigger	RHS
STC8694	90/110	Tie bracket from bulkhead rigger	LHS

Chassis - Crossmembers

ANR2056	90/110	Rear crossmember no extensions - pre-Td5	
DA4019	90*	Rear crossmember plus extensions - pre-Td5	
DA4020	110*	Rear crossmember plus extensions - pre-Td5	
DA4373	90*	Rear crossmember plus extensions - Td5	
DA4374	110*	Rear crossmember plus extensions - Td5	
DA4373S	90	Rear crossmember with short extensions - Td5	
DA4374S	110	Rear crossmember with short extensions - Td5	
KVB500060	90/110	Bolt on crossmember	
DA5300	90/110	Bolt on crossmember - galvanised with fittings *With long extensions and body brackets - see website for pictures.	
KVB500230	110	Crossmember assembly - 2nd row seats Defender - 2007 onwards - crew cab	
KVB000290	90/110	Rear crossmember no extensions - 2A627496 onwards Station wagon & crew cab galvanised bolt-on centre crossmember	
NRC4171GALV	110		

Chassis - General

DA4516	90/110	Rear tie bar mounting bracket - single	
STC8356	110	Rear outrigger	RHS/LHS
STC8648	90	Rear tubular outrigger	RHS
STC8649	90	Rear tubular outrigger	LHS
STC8652	90/110	Front chassis leg	RHS
STC8653	90/110	Front chassis leg	LHS

Chassis - Suspension Mounts

DA4509	90/110	Front axle spring mount - 40mm lift	RHS
DA4508	90/110	Front axle spring mount - 40mm lift	LHS
DA4514	90/110	Front axle spring mount - standard	RHS
DA4513	90/110	Front axle spring mount - standard	LHS
DA4515	90/110	Rear shock absorber bracket - pair	
DA4518	90/110	Rear axle spring mount - 40mm lift	
DA4527	90/110	Rear axle spring mount - standard	
STC8693	90/110	Front spring seat	RHS
STC8608	90/110	Front spring seat	LHS
STC8610	90	Rear spring seat	RHS/LHS
STC8609	110	Rear spring seat	RHS/LHS

Discovery 1 - Chassis & Body Components



Bodywork - Doors

ALR5822	Door outer skin - MA163103 onwards	Front	RHS
ALR5823	Door outer skin - MA163103 onwards	Front	LHS
ALR8576	Door outer skin - TA163104 onwards	Front	RHS
ALR8577	Door outer skin - TA163104 onwards	Front	LHS
ALR8572	Door outer skin - TA163104 onwards	Rear	RHS
ALR8573	Door outer skin - TA163104 onwards	Rear	LHS
MWC9084	Door outer skin - MA112622 onwards	Rear	RHS
MWC9085	Door outer skin - MA112622 onwards	Rear	LHS

Bodywork - Floor

ASR1186	Rear floor plate		
ASR1594	Floor panel		RHS
ASR1595	Floor panel		LHS

Bodywork - General

DA1408	Mudflap bracket kit	Rear	RHS
DA1407	Mudflap bracket kit	Rear	LHS
MWC4840	Wheel arch panel	5-door	RHS
MWC4841	Wheel arch panel	5-door	LHS
DA40080	Battery carrier		RHS
DA4008N	Battery carrier		LHS
MWC6702	Bonnet assembly		

Bodywork - Sills

MWC9060	Inner sill	3/5-door	RHS
MWC9061	Inner sill	3/5-door	LHS
STC2814	Outer sill	3-door	RHS
STC2813	Outer sill	3-door	LHS
STC2816	Outer sill	5-door	RHS
STC2815	Outer sill	5-door	LHS

Bodywork - Wings

MWC6754	Wing - up to LA081991	Front	RHS
ALR6682	Wing - MA onwards	Front	RHS
ALR6681	Wing - MA onwards	Front	LHS
ALR9877	Wing - VA onwards	Front	LHS
DA45860	Inner wing repair section	Front	RHS
DA4586N	Inner wing repair section	Front	LHS

Chassis - Bulkhead

ALR6272	Bulkhead - MA081991 onwards	Front
---------	-----------------------------	-------

Chassis - Crossmembers

ALR8519	Front floor crossmember
ALR8520	Rear crossmember
ASR1187	Rear floor crossmember
DA4530	Rear crossmember end repair panels for crossmember STC1066
STC1066	Crossmember assembly rear floor

Chassis - General

DA4516	Rear tie bar mounting bracket	Single
DA4519	Rear body mount	
DA4556 NEW	Body mount kit	

Chassis - Suspension Mounts

DA4509	Front axle spring mount - 40mm lift	RHS
DA4508	Front axle spring mount - 40mm lift	LHS
DA4514	Front axle spring mount - standard	RHS
DA4513	Front axle spring mount - standard	LHS
DA4515	Rear shock absorber bracket	Pair
DA4518	Rear axle spring mount - 40mm lift	
DA4527	Rear axle spring mount - standard	

Discovery 2 - Chassis & Body Components



DA89020
Rear chassis leg
RHS

DA8902N
Rear chassis leg
LHS

DA8903
Rear quarter chassis

DA2565 NEW
Rear half chassis

Range Rover Classic - Chassis & Body Components

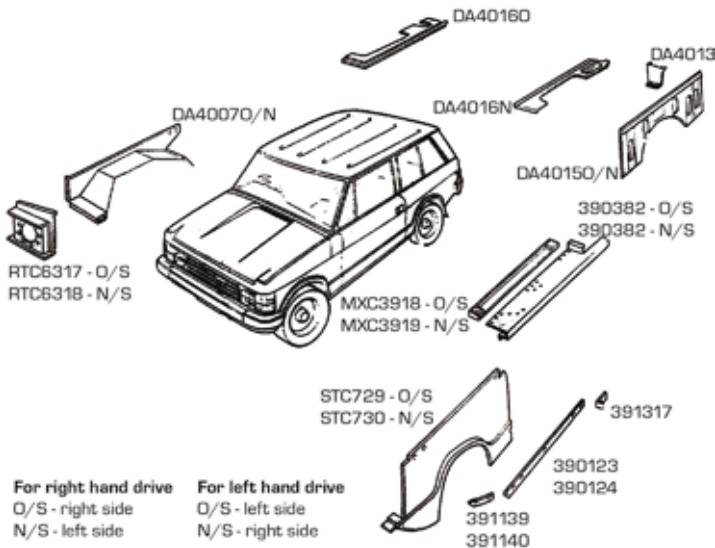

Bodywork - Doors

MXC2064	Door outer skin - front	4-door	RHS
MXC2063	Door outer skin - front	4-door	LHS

Bodywork - General

DA40130	Rear arch extension - rear		RHS
DA4013N	Rear arch extension - rear		LHS
RTC6204	Light panel - rear		LHS
RTC6317	Headlamp box		RHS
RTC6318	Headlamp box		LHS
DA40080	Battery carrier		RHS
DA4008N	Battery carrier		LHS
DA6367	Rear quarter window seal	4-door	Pair
DA6516	Rear window seal - 1970 - 1986	2-door	Pair
DA6437 NEW	Front quarter window seal	2-door	Pair
390055	Rear quarter panel fixing plate		Single
391127	Rear side window channel		Single
391141	Front wing seal		Single
391546	Side window gasket		Single
392222	Anti-rattle pad		Single
392223	Anti-rattle pad		Single
AEU1523	Rear lamp gasket		Single
AEU1525	Rear lamp gasket		Single
MRC7166	Lock & handle gasket		Single
MXC8335	Check strap seal		Single
PRC2949	Bonnet lamp rubber		Single
RTC4517CL	Glazed tailgate - 1986 - 1991		Single

Bodywork - Sills

390381	Complete sill - outer, no mounts	2-door	RHS
390382	Complete sill - outer, no mounts	2-door	LHS
DA3016	Outer sills	2-door	RHS
DA3017	Outer sills	2-door	LHS
DA41200	Half sill (repair) - outer	4-door	RHS
DA4120N	Half sill (repair) - outer	4-door	LHS
MXC3918	Sill inner	2-door	RHS
MXC3919	Sill inner	2-door	LHS
STC1136	Outer sills	4-door	RHS
STC1135	Outer sills	4-door	LHS

Bodywork - Wings

DA40070	Inner wing		RHS
DA4007N	Inner wing		LHS
DA40160	Rear inner wing - floor section	2-door	RHS
DA4016N	Rear inner wing - floor section	2-door	LHS
DA40150	Rear inner wing - side panel	2-door	RHS
DA4015N	Rear inner wing - side panel	2-door	LHS

ABS plastic front outer wing panels

DA2468	Replacement for STC729 - up to 1988		RHS
DA2467	Replacement for STC730 - up to 1988		LHS
DA2469	Replacement for MXC1408 - 1989 onwards		RHS
DA2470	Replacement for MXC1409 - 1989 onwards		LHS

DA4007N



DA2469



ALR8520



DA4516



DA4508



DA4515



Chassis - Crossmembers

ALR8520	Rear crossmember - 1990 onwards
NRC4717	Tailgate crossmember - rear

Chassis - General

DA4516	Rear tie bar mounting bracket	Single
DA4556 NEW	Body mount kit	

Chassis - Suspension Mounts

DA4509	Front axle spring mount - 40mm lift	RHS
DA4508	Front axle spring mount - 40mm lift	LHS
DA4514	Front axle spring mount - standard	RHS
DA4513	Front axle spring mount - standard	LHS
DA4515	Rear shock absorber bracket	Pair
DA4518	Rear axle spring mount - 40mm lift	
DA4527	Rear axle spring mount - standard	

For many more body & chassis product pictures go to www.britpart.com/chassis

Series 2 & 3 - Chassis & Body Components

Bodywork - Bulkhead

DA4678 **NEW**

Series 3 - universal. Accepts early type door seals. Manufactured with zinc coated steel. Etched primed and sealed. All UNF fittings. Cut outs and strengtheners in both footwells to accommodate LHD and RHD. Weld on gearbox cover. No hand throttle holes.

DA40650	SWB/LWB	Bulkhead upper repair panel	RHS
DA4065N	SWB/LWB	Bulkhead upper repair panel	LHS
DA45970	SWB/LWB	Bulkhead repair panel with vents	RHS
DA4597N	SWB/LWB	Bulkhead repair panel with vents	LHS
DA4680	SWB/LWB	Extended bulkhead upper repair panels	Pair

DA4678

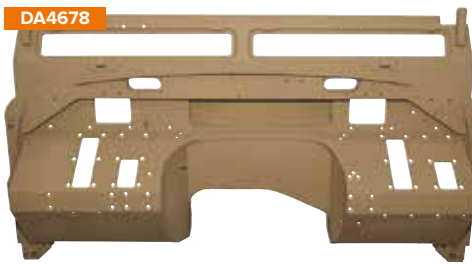

For many more body & chassis product pictures go to www.britpart.com/chassis

Bodywork - Seats

DA4682	SWB/LWB	Seat box end panel	RHS
DA4681	SWB/LWB	Seat box end panel	LHS

Bodywork - Sills

330326	SWB	Front sill panel - 5"	RHS
330327	SWB	Front sill panel - 5"	LHS
330336	SWB	Rear sill panel - 5"	RHS
330337	SWB	Rear sill panel - 5"	LHS

306460



395530



Bodywork - Doors

306460	SWB/LWB	Interior handle	
337791 NEW	SWB/LWB	Door bottom	Series 2 & 2A RHS
337792 NEW	SWB/LWB	Door bottom	Series 2 & 2A LHS
395529	SWB/LWB	Door bottom	Series 3 RHS
395530	SWB/LWB	Door bottom	Series 3 LHS
DA2007	SWB/LWB	Door rubber	30m roll
RTC6247	SWB/LWB	Safari rear door - unglazed with spare wheel	
RTC6248	SWB/LWB	Safari rear door - glazed without spare wheel	
RTC6248NG	SWB/LWB	Safari rear door - unglazed without spare wheel	
DA20260		Door pillar repair - bulkhead/bracket	RHS
DA2026N		Door pillar repair - bulkhead/bracket	LHS
DA4054		Bracket for DA2026N/DA20260 - pair	RHS/LHS
DA20230	SWB/LWB	Door skin	RHS
DA2023N	SWB/LWB	Door skin	LHS
320853 NEW	SWB/LWB	Door top - unglazed	Series 2 & 2A RHS
320854 NEW	SWB/LWB	Door top - unglazed	Series 2 & 2A LHS
MTC5382	SWB/LWB	Door top - unglazed	Series 3 RHS
MTC5383	SWB/LWB	Door top - unglazed	Series 3 LHS
MTC5382G	SWB/LWB	Door top - glazed	RHS
MTC5383G	SWB/LWB	Door top - glazed	LHS
DA4086	SWB/LWB	Rear & side door bottom repair section	
DA2156	SWB/LWB	Glazing kit - door top	Series 3
DA1070	SWB/LWB	Front door hinge kit - torx head bolts kit	
DA1131	SWB/LWB	Front door hinge kit - aluminium hinges	

MTC5382



DA20010



DA2465



DA20170

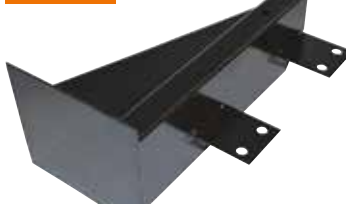

Bodywork - Footwells/Floor

DA20010	SWB/LWB	Footwell	RHD	RHS
DA2001N	SWB/LWB	Footwell	RHD	LHS
DA4018N	SWB/LWB	Footwell	LHD	RHS
DA4018O	SWB/LWB	Footwell	LHD	LHS
330037 NEW	SWB/LWB	Front footplate		RHS
330038 NEW	SWB/LWB	Front footplate		LHS

Bodywork - Windows

DA2002	SWB/LWB	Window channel	2m length	
DA4032	SWB/LWB	Window kit - standard	Pair	Clear
DA4032GREY	SWB/LWB	Window kit - standard	Pair	Grey tinted
DA4033	SWB/LWB	Window kit - deluxe	Pair	Clear
DA4033GREEN	SWB/LWB	Window kit - deluxe	Pair	Green tinted
DA4033GREY	SWB/LWB	Window kit - deluxe	Pair	Grey tinted
DA4033BRONZE	SWB/LWB	Window kit - deluxe	Pair	Bronze tinted
DA4033CATCH		Replacement catch for deluxe window kit		Single
DA4032-3SEAL		Replacement window seal for above part numbers. One seal per kit.		

Bodywork - Wings & Nose

Aluminium front outer wing panels

330426		Series 2 & 2A - right & left hand drive	RHS with no hole
330427		Series 2 & 2A - right & left hand drive	LHS with no hole
347474		Series 3 - left hand drive	RHS with hole
347475 NEW		Series 3 - right hand drive	LHS with hole

ABS plastic front outer wing panels

DA2463		Series 2 & 2A - right & left hand drive	RHS with no hole
		Series 3 - right hand drive	LHS with no hole
DA2462		Series 2 & 2A - right & left hand drive	LHS with no hole
		Series 3 - left hand drive	RHS with no hole
DA2464		Series 3 - right hand drive	LHS with hole
DA2465		Series 3 - left hand drive	RHS with hole
DA2521	Series 3	Nose panel	RHS
DA2520	Series 3	Nose panel	LHS

Bodywork - General

DA6110		Series 1/Series 2/Series 2A	Headlamp surround - chrome
DA1362		Series 2/2A - up to suffix A	Radiator panel
NEW		Series 2A - suffix B to suffix F	Radiator panel
DA1361		Series 3	Radiator panel
NEW			Radiator panel
DA1363			Radiator panel
NEW			Radiator panel
C Post repair sections are 1.2mm thick zintec coated mild steel. Machine cut and CNC pressed for accuracy. Supplied in two pieces for ease of fitting. Ready to weld in place.			
DA1353		Series LWB - Station Wagon	LHS
NEW			
DA1354		Series LWB - Station Wagon	RHS
NEW			

DA1362



DA1353



Chassis - Crossmembers

218453	SWB	Gearbox crossmember - weld on
559822	Military	Rear crossmember
DA4017	SWB	Rear crossmember / ¼ chassis with extensions and hangers
NRC236	SWB/LWB	Rear crossmember - no extensions
NRC236E	SWB/LWB	Rear crossmember - with extensions, no hangers

Chassis - General

DA20080	SWB/LWB	Chassis leg - front	RHS
DA2008N	SWB/LWB	Chassis leg - front	LHS
DA2009	SWB/LWB	Extension piece (2 x 'U' shape sections) for rear crossmember	
DA2014	SWB/LWB	Bulkhead outrigger	
DA20150	SWB	Rear tank outrigger	RHS
DA2015N	SWB	Rear tank outrigger	LHS
DA20170	LWB	Rear tank outrigger	RHS
DA2017N	LWB	Rear tank outrigger	LHS
DA20190	SWB	Front tank outrigger	RHS
DA2019N	SWB	Front tank outrigger	LHS
DA2099	SWB	½ Chassis	

Chassis - Suspension Mounts

DA2013	SWB	Spring hanger
DA2016	LWB	Spring hanger - front
DA2116	LWB	Spring hanger - rear

DA2099



DA2013



Other - Chassis & Body Components



Freelander 1
ALR8710 Bulkhead front assembly



Freelander 2
DA5671 Bumper
With headlamp power wash, front parking aid & front fog lamps.



Discovery 3
DA5672 Bumper
With headlamp power wash & front parking aid

Door Hinge Kits



DA1131



DA1309



DA1305



DA1306



DA1070



DA1070SS



DA1240



DA1240SS

DA1131	Defender/Series 3	Front doors with natural finish aluminium door hinges and stainless steel hinge pins. 4 hinges per set complete with fixings.
DA1309	Defender/Series 3	2nd row doors with natural finish aluminium door hinges and stainless steel hinge pins. 4 hinges per set complete with fixings.
DA1305	Defender/Series 3	Front doors with anodised black aluminium door hinges and stainless steel hinge pins. 4 hinges per set complete with fixings.
DA1306	Defender/Series 3	2nd row doors with anodised black aluminium door hinges and stainless steel hinge pins. 4 hinges per set complete with fixings.
DA1070	Defender/Series 3	Front door hinge kit with torx head bolts and all other fixings. Defender - 2007 onwards but can be used on earlier vehicles. Zinc plated.
DA1070SS	Defender/Series 3	Front door hinge kit with stainless steel torx head bolts and all other fixings. Defender - 2007 onwards but can be used on earlier vehicles.
DA1275	Defender/Series 3	2nd row door hinge kit with torx head bolts and all other fixings. Defender - 2007 onwards but can be used on earlier vehicles.
DA1275SS	Defender/Series 3	2nd row door hinge kit with stainless steel torx head bolts and all other fixings. Defender - 2007 onwards but can be used on earlier vehicles.
DA1240	Defender/Series 2/3	Rear end door hinge kit. Supplied with stainless steel fitting kit.
DA1240SS	Defender/Series 2/3	Rear end door hinge kit. Supplied with stainless steel torx head. Defender - 2007 onwards but can be used on earlier vehicles.
DA1392 NEW	Defender/Series 2/3	Rear end door hinge kit. Cast from marine grade 316 stainless steel and polished. Supplied with stainless steel fitting kit.



DA1392



facebook.com/britpart



Photo courtesy of Nick Mahon

Tailgate Half Door Kit



DA6520
Defender
Converts a vehicle with a drop down tailgate to a side opening half door. Ideal for pick-ups and soft-tops.

Door Lock Button Kit



DA2499
Defender
3 piece door lock button kit
Black

Tailgate Hinge Brackets



DA2498
Series
Defender

Fuel Tank Fitting Kit



DA2542
Fitting kit to fit Series SWB fuel tank - 552174

Fuel Latch Repair Kit



DA1114
Discovery 3/Discovery 4/Range Rover Sport - 2015 - 2013
This handy little OEM kit is used to repair the temperamental fuel latch.

Window Kits

DA4032GREY



DA4033GREY



DA4033GREEN



DA4033



Deluxe - Defender & Series

Deluxe kits have rubber mounting strips to cover rivets and a plastic catch. Glass is toughened to E11 CE R - 43.

DA4033	Clear	Pair
DA4033GREEN	Green tinted	Pair
DA4033GREY	Grey tinted	Pair
DA4033BRONZE	Bronze tinted	Pair

Standard - Defender & Series

Standard kits have a metal catch. Glass is toughened to E11 CE R - 43.

DA4032	Clear	Pair
DA4032GREY	Grey tinted	Pair

DA4032-3SEAL

Replacement window seal for both standard and deluxe windows. Each kit does one window.



DA4033CATCH

Replacement catch for deluxe window kit. Single.





Britpart Service Kits
Quality service parts manufactured to O.E. specification and competitively priced.

Britpart Service Kits with Oil



Britpart Service Kits with Oil
Quality service parts manufactured to O.E. specification and competitively priced with the relevant Britpart XD oil which meets Land Rover's specifications.

“Servicing a Land Rover just got a whole lot easier with Britpart!”

Land Rover Service Kits
A wide range of service kits using genuine filters and spark/heater plugs.



Ever started servicing a Land Rover and then suddenly realised you haven't ordered a filter or forgotten the sump plug washers?

Well now thanks to Britpart with one simple part number you can order your Land Rover kit safe in the knowledge that all the parts you need will be there for you to complete the job. No more half-finished services!

Alternative Brand Service Kits
Britpart stock a wide range of alternative brand service kits with OEM brands including Coopers, Mann, Mahle, Champion & NGK.



Pictures for illustrative purposes only

Note
Blue part numbers - Britpart filters & spark/heater plugs
Red part numbers ending in 'P' - OEM filters & spark/heater plugs
Green part numbers ending in 'LR' - Genuine filters & spark/heater plugs
Purple part numbers ending in 'COM' - Britpart filters & spark/heater plugs with Britpart XD oil

Defender

DA6000
Defender - 2½ petrol
7:1 compression ratio
1 x ERR3340 Oil filter
1 x NRC9238 Air filter
1 x JS660L Fuel filter
1 x 243959 Sump plug washer
1 x FRC4808 Sump plug washer
4 x RTC3571 Spark plugs

DA6003 **DA6003P**
DA6003COM - Britpart kit with 10W 40 oil
Defender - 300Tdi
1 x ERR3340 Oil filter
1 x ESR2623 Air filter
1 x AEU2147L Fuel filter
1 x UAM2857L Sump plug washer
1 x ALU1403L Sump plug washer

DA6040 **DA6040P** **DA6040LR**
DA6040COM - Britpart kit with 5W 30 oil
Defender - 2007 onwards
2.4 & 2.2 - up to DA444246
1 x LR004459 Oil filter
1 x WJ1500040 Fuel filter
1 x PHE500060 Air filter
1 x 1013938 Oil drain plug inc. rubber seal

DA6032
Series 2¼ petrol - 1964 onwards
Lucas ignition (fixed points)
1 x RTC3184 Oil filter
1 x 606168 Fuel filter (in-line)
4 x RTC3570 Spark plugs
1 x RTC3270 Points (fixed)
1 x RTC3472 Condenser
1 x 243959 Sump plug washer

DA6001 **DA6001P**
DA6001COM - Britpart kit with 10W 40 oil
Defender - Turbo D
1 x ERR3340 Oil filter
1 x NRC9238 Air filter
1 x RTC6079 Fuel filter
1 x FRC4808 Sump plug washer

DA6004 **DA6004P** **DA6004LR**
DA6004COM - Britpart kit with 5W 30 oil
Defender - Td5
1 x LPX100590 Oil filter
1 x ESR4238 Air filter
1 x ERR6299 Rotor filter
1 x ESR4686 Fuel filter
1 x CDU1001L Sump plug washer

DA6109 **DA6109P** **DA6109LR**
DA6109COM - Britpart kit with 5W 30 oil
Defender - 2007 onwards
2.2 - DA444247 onwards
1 x LR058104 Oil filter
1 x WJ1500040 Fuel filter
1 x PHE500060 Air filter
1 x 1013938 Oil drain plug inc. rubber seal

DA6033
Series 2¼ petrol - 1964 onwards
Lucas ignition (sliding points)
1 x RTC3184 Oil filter
1 x 606168 Fuel filter (in-line)
4 x RTC3570 Spark plugs
1 x RTC364 Points (sliding)
1 x RTC3288 Points (sliding)
1 x RTC6621 Condenser
1 x 243959 Sump plug washer

DA6002 **DA6002P**
DA6002COM - Britpart kit with 10W 40 oil
Defender - 200Tdi
1 x ERR3340 Oil filter
1 x NTC6660 Air filter
1 x AEU2147L Fuel filter
1 x 213961L Sump plug washer
1 x ETC7398 Sump plug washer

DA6004XD
Defender - Td5
1 x LPX100590XD Oil filter
Shorter than the standard filter which makes this one easier to fit and remove.
1 x ESR4238 Air filter
1 x ERR6299 Rotor filter
1 x ESR4686 Fuel filter
1 x CDU1001L Sump plug washer

DA6034
Series 2¼ petrol - 1964 onwards
(Ducellier ignition)
1 x RTC3184 Oil filter
1 x 606168 Fuel filter (in-line)
4 x RTC3570 Spark plugs
1 x RTC6625 Points
1 x RTC6620 Condenser
1 x 243959 Sump plug washer

www.britpart.com/servicekits

Discovery

Discovery 1

DA6005	DA6005P
Discovery 1 - 200Tdi - up to JA018272	
1 x ERR3340	Oil filter
1 x NTC1435	Air filter
1 x AEU2147L	Fuel filter
1 x 213961L	Sump plug washer
DA6006	DA6006P
DA6006COM - Britpart kit with 10W 40 oil	
Discovery 1 - 200Tdi - JA018273 onwards	
1 x ERR3340	Oil filter
1 x ESR1049	Air filter
1 x AEU2147L	Fuel filter
1 x 213961L	Sump plug washer
DA6007	DA6007P
DA6007COM - Britpart kit with 10W 40 oil	
Discovery 1 - 300Tdi	
1 x ERR3340	Oil filter
1 x ESR1445	Air filter
1 x AEU2147L	Fuel filter
1 x UAM2857L	Sump plug washer
1 x ALU1403L	Sump plug washer
DA6008	
Discovery 1 - 3.5 Efi	
1 x ERR3340	Oil filter
1 x RTC4683	Air filter
8 x ERR3799	Spark plugs
1 x ESR4065	Fuel filter (in-line)
1 x 213961L	Sump plug washer
DA6009	
Discovery 1 - 3.9 Efi	
1 x ERR3340	Oil filter
1 x ESR1445	Air filter
1 x ESR4065	Fuel filter
1 x ETC7398	Sump plug washer

Discovery 2

DA6004	DA6004P	DA6004LR
DA6004COM - Britpart kit with 5W 30 oil		
Discovery 2 - Td5		
1 x LPX100590	Oil filter	
1 x ESR4238	Air filter	
1 x ERR6299	Rotor filter	
1 x ESR4686	Fuel filter	
1 x CDU1001L	Sump plug washer	
DA6004XD		
Discovery 2 - Td5		
1 x LPX100590XD	Oil filter	
Shorter than the standard filter which makes this one easier to fit and remove.		
1 x ESR4238	Air filter	
1 x ERR6299	Rotor filter	
1 x ESR4686	Fuel filter	
1 x CDU1001L	Sump plug washer	
DA6010	DA6010P	DA6010LR
Discovery 2 - V8 4.0		
1 x ERR3340	Oil filter	
1 x ESR4238	Air filter	
8 x NLP100320	Spark plugs	
1 x ALU1403L	Sump plug washer	

"All the parts you need will be there for you to complete the job"

Discovery 3

DA6035	DA6035P	DA6035LR
DA6035COM - Britpart kit with 5W 30 oil		
Discovery 3 - 2.7 diesel - up to 6A999999		
1 x 1311289	Oil filter	
1 x PHE000112	Air filter	
1 x LR010075	Fuel filter	
1 x JKR500020	Cabin filter	
1 x 1013938	Oil drain plug inc. rubber seal	
DA6041	DA6041P	DA6041LR
DA6041COM - Britpart kit with 5W 30 oil		
Discovery 3 - 2.7 diesel - 7A onwards		
1 x 1311289	Oil filter	
1 x PHE000112	Air filter	
1 x JKR500020	Cabin filter	
1 x LR009705	Fuel filter	
1 x 1013938	Oil drain plug inc. rubber seal	
DA6037	DA6037P	DA6037LR
Discovery 3 - 4.4 petrol		
1 x LR007160	Oil filter	
1 x PHE000112	Air filter	
8 x LR005253	Spark plugs	
1 x JKR500020	Cabin filter	
1 x 1013938	Oil drain plug inc. rubber seal	
DA6087	DA6087P	DA6087LR
Discovery 3 - 4.0 V6 petrol		
1 x 4454116	Oil filter	
(vehicles with engine oil cooler)		
1 x PHE000112	Air filter	
1 x JKR500020	Cabin filter	
6 x LR000604	Spark plugs	
1 x 1013938	Oil drain plug inc. rubber seal	

Discovery 4

DA6041	DA6041P	DA6041LR
DA6041COM - Britpart kit with 5W 30 oil		
Discovery 4 - 2.7 diesel		
1 x 1311289	Oil filter	
1 x PHE000112	Air filter	
1 x JKR500020	Cabin filter	
1 x LR009705	Fuel filter	
1 x 1013938	Oil drain plug inc. rubber seal	
DA6086	DA6086P	DA6086LR
DA6086COM - Britpart kit with 5W 30 oil		
Discovery 4 - 3.0 V6 diesel		
1 x LR013148	Oil filter	
1 x PHE000112	Air filter	
1 x JKR500020	Cabin filter	
1 x LR009705	Fuel filter	
1 x 1013938	Oil drain plug inc. rubber seal	
DA6087	DA6087P	DA6087LR
Discovery 4 - 4.0 V6 petrol		
1 x 4454116	Oil filter	
(vehicles with engine oil cooler)		
1 x PHE000112	Air filter	
1 x JKR500020	Cabin filter	
6 x LR000604	Spark plugs	
1 x 1013938	Oil drain plug inc. rubber seal	
DA6088	DA6088P	DA6088LR
Discovery 4 - 5.0 V8 petrol		
1 x LR011279	Oil filter	
2 x LR011593	Air filters	
1 x JKR500020	Cabin filter	
8 x LR032080	Spark plugs	
1 x 4594914	Oil drain plug	



Photo courtesy of Cyril Mischler

Discovery Sport

DA6089	DA6089P	DA6089LR
Discovery Sport - 2.0 petrol		
1 x LR025306	Oil filter	
1 x LR029078	Air filter	
1 x LR056138	Cabin filter	
4 x LR025605	Spark plugs	
1 x LR025048	Oil drain plug	
DA6091	DA6091P	DA6091LR
Discovery Sport - 2.2 diesel		
1 x LR001247	Oil filter	
1 x LR029078	Air filter	
1 x LR056138	Cabin filter	
1 x LR001313	Fuel filter	
1 x LR004304	Oil drain plug	
1 x LR006295	Oil drain plug seal	
DA6123LR		
Discovery Sport - 2.0 single turbo diesel (AJ200) from GH000001		
1 x LR073669	Oil filter	
1 x LR071942	Air filter	
1 x LR085987	Fuel filter	
1 x LR079995	Foam pad	
1 x LR056138	Cabin filter	
1 x 1013938	Oil drain plug inc. rubber seal	

Freelander

www.britpart.com/servicekits

Freelander 1

DA6011		
Freelander 1 - 1.8 petrol - up to YA999999		
1 x CDU1268	Oil filter	
1 x ESR4103	Air filter	
1 x JKR100200	Pollen filter	
1 x ALU1403L	Sump plug washer	
4 x NLP100290L	Spark plugs	
DA6012		
Freelander 1 1.8 petrol - 1A000001 onwards		
1 x CDU1268	Oil filter	
1 x ESR4103	Air filter	
1 x JKR100280	Pollen filter	
1 x ALU1403L	Sump plug washer	
DA6013	DA6013P	
Freelander 1 - 2.0 diesel TCIE		
1 x ERR5542	Oil filter	
1 x ESR4103	Air filter	
1 x WJN10046	Fuel filter	
1 x JKR100200	Pollen filter	
1 x ALU1403L	Sump plug washer	
DA6014	DA6014P	DA6014LR
Freelander 1 - Td4 - up to 2A209830		
1 x LRF100150L	Oil filter	
1 x PHE100500L	Air filter	
1 x JKR100280	Pollen filter	
1 x ALU1403L	Sump plug washer	
1 x MUN000010	Fuel filter	
DA6015	DA6015P	DA6015LR
DA6015COM - Britpart kit with 10W 40 oil		
Freelander 1 - Td4 - 2A209831 onwards		
1 x LRF100150L	Oil filter	
1 x PHE100500L	Air filter	
1 x JKR100280	Pollen filter	
1 x ALU1403L	Sump plug washer	
1 x WJN000080	Fuel filter	

Freelander 2

DA6038	DA6038P	DA6038LR
DA6038COM - Britpart kit with 5W 30 oil		
Freelander 2 - 2.2 diesel		
1 x LR001247	Oil filter	
1 x LR005816	Air filter	
1 x LR001313	Fuel filter	
1 x LR056138	Cabin filter	
1 x LR006295	Drain plug gasket	
DA6039	DA6039P	DA6039LR
Freelander 2 - 3.2 petrol		
1 x LR001419	Oil filter	
1 x LR005816	Air filter	
6 x LR005483	Spark plugs	
1 x LR056138	Cabin filter	
1 x LR000506	Drain plug gasket	
DA6089	DA6089P	DA6089LR
Freelander 2 - 2.0 petrol		
1 x LR025306	Oil filter	
1 x LR029078	Air filter	
1 x LR056138	Cabin filter	
4 x LR025605	Spark plugs	
1 x LR025048	Oil drain plug	

"No more half finished services"



facebook.com/britpart



Photo courtesy of Bogdan Muscalu

Range Rover

Range Rover Classic

DA6016

Range Rover Classic - 3.5 - 1970 - 1975

1 x RTC3186	Oil filter
2 x 605191	Air filters
1 x JS660L	Fuel filter
8 x RTC3573	Spark plugs
1 x 213961L	Sump plug washer
2 x 603330	Flame traps
1 x RTC6623	Points (fixed)
1 x RTC3472	Condenser

DA6017

Range Rover Classic - 3.5 - 1975 - 1982

1 x ERR3340	Oil filter
2 x 605191	Air filters
1 x JS660L	Fuel filter
8 x RTC3573	Spark plugs
1 x 213961L	Sump plug washer
2 x 603330	Flame traps
1 x RTC6623	Points (fixed)
1 x RTC3472	Condenser

DA6018

Range Rover Classic - 3.5 - 1982 - 1983

1 x ERR3340	Oil filter
2 x 605191	Air filters
1 x JS660L	Fuel filter
8 x RTC3570	Spark plugs
1 x 213961L	Sump plug washer
2 x 603330	Flame traps
1 x RTC6626	Points (sliding)
1 x RTC3472	Condenser

DA6019

Range Rover Classic - 3.5 - 1984 - 1986

1 x ERR3340	Oil filter
2 x 605191	Air filters
1 x JS660L	Fuel filter
8 x RTC3570	Spark plugs
1 x 213961L	Sump plug washer
2 x 603330	Flame traps

DA6020

Range Rover Classic - 3.5 carb

- 1986 - 1991

1 x ERR3340	Oil filter
2 x 605191	Air filters
1 x JS660L	Fuel filter
8 x RTC3812	Spark plugs
1 x 213961L	Sump plug washer
2 x 603330	Flame traps

DA6021

Range Rover Classic - 3.5/3.9 Efi

1986 - 1991 up to GA464553

1 x ERR3340	Oil filter
1 x RTC4683	Air filter
1 x NTC5958	Fuel filter
1 x 213961L	Sump plug washer

DA6022

Range Rover Classic - 3.9 Efi

1986 - 1994 from HA464554 up to LA647644

1 x ERR3340	Oil filter
1 x RTC4683	Air filter
1 x ESR4065	Fuel filter
1 x 213961L	Sump plug washer

DA6023

Range Rover Classic - 3.9 Efi

1992 - 1994 - MA647645 onwards

1 x ERR3340	Oil filter
1 x ESR1445	Air filter
1 x ESR4065	Fuel filter
8 x ETC7244	Spark plugs
1 x 213961L	Sump plug washer

DA6024

Range Rover Classic - 4.2 - 1992 - 1994

1 x ERR3340	Oil filter
1 x ESR1445	Air filter
1 x ESR4065	Fuel filter
8 x ERR3799	Spark plugs
1 x 213961L	Sump plug washer

DA6006

DA6006P

DA6006COM - Britpart kit with 10W 40 oil

Range Rover Classic - 200Tdi

1 x ERR3340	Oil filter
1 x ESR1049	Air filter
1 x AEU2147L	Fuel filter
1 x 213961L	Sump plug washer

DA6007

DA6007P

DA6007COM - Britpart kit with 10W 40 oil

Range Rover Classic - 300Tdi

1 x ERR3340	Oil filter
1 x ESR1445	Air filter
1 x AEU2147L	Fuel filter
1 x UAM2857L	Sump plug washer
1 x ALU1403L	Sump plug washer

Range Rover P38

DA6025

Range Rover P38 - 4.0/4.6 up to

TA346793 & from WA376580 up to

WA385948

1 x ERR3340	Oil filter
1 x ESR341	Air filter
1 x ESR4065	Fuel filter
8 x ERR3799	Spark plugs
2 x BTR8037	Pollen filters
1 x UAM2857L	Sump plug washer
1 x ALU1403L	Sump plug washer

DA6026

Range Rover P38 - 4.0/4.6 from

VA346794 up to VA376579 & from

WA385949 onwards

1 x ERR3340	Oil filter
1 x ESR4238	Air filter
1 x ESR4065	Fuel filter
8 x ERR3799	Spark plugs
2 x BTR8037	Pollen filters
1 x UAM2857L	Sump plug washer
1 x ALU1403L	Sump plug washer

DA6027

DA6027P

Range Rover P38 - 2.5 DT to engine no.

33978348 up to (Dec 1995)

type A oil filter

1 x STC2180	Oil filter type A
1 x ESR341	Air filter
1 x STC2827	Fuel filter
2 x BTR8037	Pollen filters
1 x VYX000040	Sump plug washer

DA6028

DA6028P

Range Rover P38 - 2.5 DT from engine

no. 33988348 from (Dec 1995)

up to TA346793 type B oil filter

1 x STC3350	Oil filter type B
1 x ESR341	Air filter
1 x STC2827	Fuel filter
2 x BTR8037	Pollen filters
1 x VYX000040	Sump plug washer

DA6029

DA6029P

Range Rover P38 - 2.5 DT from engine

no. 33988348 from (Dec 1995)

from TA346794 type B oil filter

1 x STC3350	Oil filter type B
1 x ESR4238	Air filter
1 x STC2827	Fuel filter
2 x BTR8037	Pollen filters
1 x VYX000040	Sump plug washer

Range Rover L322

DA6030

DA6030P

DA6030LR

DA6030COM - Britpart kit with 5W 30 oil

Range Rover L322 - 3.0 diesel

1 x LPZ000020	Oil filter
1 x PHE000040	Air filter
1 x WFL000070	Fuel filter
1 x JMO000010	Pollen filter
1 x VYX000040	Sump plug washer

DA6031

DA6031P

DA6031LR

Range Rover L322 - 4.4 V8 M62

1 x LPW500030	Oil filter
1 x PHE000050	Air filter
1 x JMO000010	Pollen filter
1 x VYX000040	Sump plug washer
8 x NLP000030	Spark plugs

DA6065

DA6065P

DA6065LR

Range Rover L322 - 4.4 V8 AJ petrol

& 4.2 Supercharged

1 x LR007160	Oil filter
1 x PHE500021	Air filter
1 x JMO000010	Cabin filter
8 x LR005253	Spark plugs
1 x 1013938	Oil drain plug inc. rubber seal

DA6066

DA6066P

DA6066LR

Range Rover L322 - 3.6 V8 diesel

1 x LR002338	Oil filter
1 x PHE500021	Air filter
1 x JMO000010	Cabin filter
1 x WJ1500030	Fuel filter
1 x 1013938	Oil drain plug inc. rubber seal

DA6067

DA6067P

DA6067LR

Range Rover L322 - 4.4 V8 diesel

1 x LR022896	Oil filter
2 x LR011593	Air filters
1 x JMO000010	Cabin filter
1 x LR029098	Fuel filter element
1 x 4594914	Oil drain plug

DA6068

DA6068P

DA6068LR

Range Rover L322 - 5.0 V8 petrol

1 x LR011279	Oil filter
2 x LR011593	Air filters
1 x JMO000010	Cabin filter
8 x LR032080	Spark plugs
1 x 4594914	Oil drain plug

More Range Rover service kits overleaf >>>

www.britpart.com/servicekits



Photo courtesy of Liam Stevenson

Range Rover - continued

Range Rover L405

DA6095	DA6095P	DA6095LR
Range Rover - 3.0 V6 diesel		
1 x LR013148	Oil filter	
2 x LR011593	Air filter	
1 x LR041978	Fuel filter	
1 x LR036369	Cabin filter	
1 x 1013938	Oil drain plug inc. rubber seal	

DA6096P	DA6096LR
Range Rover - 4.4 V8 diesel	
1 x LR022896	Oil filter
2 x LR011593	Air filter
1 x LR029098	Fuel filter
1 x LR036369	Cabin filter
1 x 4594914	Oil drain plug inc. rubber seal

DA6097	DA6097P	DA6097LR
Range Rover - 3.0 V6 petrol - up to EA128397		
1 x LR011279	Oil filter	
2 x LR011593	Air filter	
1 x LR036369	Cabin filter	
6 x LR041664	Spark plugs	
1 x 4594914	Oil drain plug inc. rubber seal	

DA6098	DA6098P	DA6098LR
Range Rover - 3.0 V6 petrol - EA128398 onwards		
1 x LR011279	Oil filter	
2 x LR011593	Air filter	
1 x LR036369	Cabin filter	
6 x LR050998	Spark plugs	
1 x 4594914	Oil drain plug inc. rubber seal	

DA6099	DA6099P	DA6099LR
Range Rover - 5.0 V8 petrol naturally aspirated & supercharged - 2014 MY		
1 x LR011279	Oil filter	
2 x LR011593	Air filter	
1 x LR036369	Cabin filter	
8 x LR032080	Spark plugs	
1 x 4594914	Oil drain plug inc. rubber seal	

DA6122	DA6122P	DA6122LR
Range Rover - 2.0 turbo petrol from FA000001		
1 x LR025306	Oil filter	
1 x LR011593	Air filter	
1 x LR036369	Cabin filter	
4 x LR025605	Spark plugs	
1 x LR025048	Oil drain plug inc. rubber seal	

Range Rover Sport

DA6035	DA6035P	DA6035LR
DA6035COM - Britpart kit with 5W 30 oil		
Range Rover Sport - 2.7 diesel up to 6A999999		
1 x 1311289	Oil filter	
1 x PHE000112	Air filter	
1 x LR010075	Fuel filter	
1 x JKR500020	Cabin filter	
1 x 1013938	Oil drain plug inc. rubber seal	

DA6048	DA6048P	DA6048LR
Range Rover Sport - 2.7 diesel from 7A000001		
1 x 1311289	Oil filter	
1 x PHE000112	Air filter	
1 x LR009705	Fuel filter	
1 x JKR500020	Cabin filter	
1 x 1013938	Oil drain plug inc. rubber seal	

DA6036	DA6036P	DA6036LR
Range Rover Sport - 3.6 diesel		
1 x LR002338	Oil filter	
1 x PHE000112	Air filter	
1 x LR009705	Fuel filter	
1 x JKR500020	Cabin filter	
1 x 1013938	Oil drain plug inc. rubber seal	

DA6037	DA6037P	DA6037LR
Range Rover Sport - 4.2/4.4 petrol		
1 x LR007160	Oil filter	
1 x PHE000112	Air filter	
8 x LR005253	Spark plugs	
1 x JKR500020	Cabin filter	
1 x 1013938	Oil drain plug inc. rubber seal	

DA6086	DA6086P	DA6086LR
DA6086COM - Britpart kit with 5W 30 oil		
Range Rover Sport - 3.0 V6 diesel		
1 x LR013148	Oil filter	
1 x PHE000112	Air filter	
1 x JKR500020	Cabin filter	
1 x LR009705	Fuel filter	
1 x 1013938	Oil drain plug inc. rubber seal	

DA6088	DA6088P	DA6088LR
Range Rover Sport - 5.0 V8 petrol		
1 x LR011279	Oil filter	
2 x LR011593	Air filters	
1 x JKR500020	Cabin filter	
8 x LR032080	Spark plugs	
1 x 4594914	Oil drain plug	

DA6095	DA6095P	DA6095LR
Range Rover Sport - 3.0 V6 diesel - EA000001 onwards		
1 x LR013148	Oil filter	
2 x LR011593	Air filter	
1 x LR041978	Fuel filter	
1 x LR036369	Cabin filter	
1 x 1013938	Oil drain plug inc. rubber seal	

DA6096P	DA6096LR
Range Rover Sport - 4.4 V8 diesel - BA000001 onwards	
1 x LR022896	Oil filter
2 x LR011593	Air filter
1 x LR029098	Fuel filter
1 x LR036369	Cabin filter
1 x 4594914	Oil drain plug inc. rubber seal

DA6097	DA6097P	DA6097LR
Range Rover Sport - 3.0 V6 petrol - up to EA301262		
1 x LR011279	Oil filter	
2 x LR011593	Air filter	
1 x LR036369	Cabin filter	
6 x LR041664	Spark plugs	
1 x 4594914	Oil drain plug inc. rubber seal	

DA6098	DA6098P	DA6098LR
Range Rover Sport - 3.0 V6 petrol - EA301263 onwards		
1 x LR011279	Oil filter	
2 x LR011593	Air filter	
1 x LR036369	Cabin filter	
6 x LR050998	Spark plugs	
1 x 4594914	Oil drain plug inc. rubber seal	

DA6099	DA6099P	DA6099LR
Range Rover Sport - 5.0 V8 petrol natu- rally aspirated & supercharged - 2014 MY		
1 x LR011279	Oil filter	
2 x LR011593	Air filter	
1 x LR036369	Cabin filter	
8 x LR032080	Spark plugs	
1 x 4594914	Oil drain plug inc. rubber seal	

DA6122	DA6122P	DA6122LR
Range Rover Sport - 2014 onwards - 2.0 turbo petrol from FA000001		
1 x LR025306	Oil filter	
1 x LR011593	Air filter	
1 x LR036369	Cabin filter	
4 x LR025605	Spark plugs	
1 x LR025048	Oil drain plug inc. rubber seal	

Range Rover Evoque

DA6089	DA6089P	DA6089LR
Range Rover Evoque - 2.0 petrol		
1 x LR025306	Oil filter	
1 x LR029078	Air filter	
1 x LR056138	Cabin filter	
4 x LR025605	Spark plugs	
1 x LR025048	Oil drain plug	

DA6091	DA6091P	DA6091LR
Range Rover Evoque - 2.2 diesel		
1 x LR001247	Oil filter	
1 x LR029078	Air filter	
1 x LR056138	Cabin filter	
1 x LR001313	Fuel filter	
1 x LR004304	Oil drain plug	
1 x LR006295	Oil drain plug seal	

DA6123LR	
Range Rover Evoque - 2.0 single turbo diesel (AJ200) from GH000001	
1 x LR073669	Oil filter
1 x LR071942	Air filter
1 x LR085987	Fuel filter
1 x LR079995	Foam pad
1 x LR056138	Cabin filter
1 x 1013938	Oil drain plug inc. rubber seal



Automatic Transmission Fluid Change Kits

Degradation in oil can lead to judder, noise and a deterioration in gear change quality. It is recommended that oil and filters are changed after 50,000 to 75,000 miles on all 5, 6 & 8 speed automatic gearboxes to ensure optimum performance.

DA6085 Britpart pan with Ravenol oil
DA6085G ZF pan with ZF oil
Automatic transmission fluid change kit for vehicles with either a 6HP26 or 6HP28 ZF 6-speed automatic gearbox. Ideal for high mileage vehicles and towing vehicles. Kit comprises of pan assembly, transmission fluid, screws, sleeve & plugs.

Suitable for -
Discovery 3 & Discovery 4
Range Rover Sport - 2005 - 2013
Range Rover L322

Also see DA2142 & DA2142G in transmission section.

DA6106 Britpart pan with ZF oil
Automatic transmission fluid change kit for vehicles with ZF 8HP70 8-speed automatic gearbox. Ideal for high mileage vehicles and towing vehicles. Kit comprises of pan assembly, transmission fluid, screws & plug.

Suitable for -
Discovery 4
Range Rover L322 - 2010 - 2012
Range Rover Sport - 2010 - 2013 & 2014 onwards

DA6085



DA6106



Service Sticker

SERVICE STICKER

Helpful stickers to remind customers when they are due another service.

Pack of 10



Clips, Clamps & Nipples



Exhaust Clamps

DA4062	45mm	Qty 1
DA4186	54mm	Qty 1
DA4063	60mm	Qty 1
DA4064	65mm	Qty 1

Jubilee Clips

CN100208L	20mm	Qty 10
CN100508L	32 - 52mm	Qty 5
CN100909	70 - 90mm	Qty 1

Grease Nipples

234532	Short thread	Qty 10
TYL100030	Long thread	Qty 10

Swivel Housing Grease



STC3435	370gm bottle
STC3435S	370ml sachet

- > Formulated for all Land Rover models with ball type swivel housings.
- > Lubricates swivel pins and housing seals, protects spheres.
- > A semi-fluid grease designed to withstand shock loading in oscillating joints.
- > Reinforced with solid lubricants, highly resistant to water and salt corrosion.
- > Better lubrication while driving, less leaks while standing.
- > One shot gives 'filled for life' protection.

Brake Cleaner



STC8972
500ml aerosol TRW brake cleaner

- > Cleans & degreases brake and clutch parts.
- > Evaporates quickly.
- > Simplifies dismantling and assembly.
- > Removes dust, oil, grease & brake fluid.
- > Sprays from any angle.

Trade Tack Stab



DA6348
Super bond spray adhesive.

- > High strength
 - > Variable spray
 - > Quick
 - > Clean
 - > High tack/long tack
 - > Very fast set
 - > 250ml aerosol
- Ideal for bonding and laminating of polyurethane foam, polystyrene foam, fibres, fabrics & felts etc to themselves.



Sign up to the regular Britpart newsletter to find out about all the latest product releases. www.britpart.com/newsletter

Hylomar Sealants & Compounds



RTC3347

Hylomar Universal Blue - gasket & jointing compound - 100g

Non setting universal jointing compound that is resistant to fuels, coolants and lubricants. Use on gaskets and machined metal surfaces. High temperature capability up to 250°C with unlimited assembly time. Easy disassembly for service maintenance and allows for differential thermal expansion of components. Excellent vibration resistance.

STC4404

Hylomar 607 Silicone Sealant - 300ml

Engineering grade with excellent gap filling properties. Forms any size or shape of gasket instantly and remains flexible and will not shrink. Bonds to metal, glass, ceramics, plastics, fibres and wood. Resists most solvents. Good fluid resistance - not petrol or diesel. Electrical insulator with maximum constant operating temperature 250°C. Neutral curing. Tolerant of some oil and grease, ensure surfaces are clean.



RTC3254

Hylomar 101 Silicone Sealant - gasketing, sealing & bonding compound - 85g

Engineering grade which forms any size or shape of gasket instantly and remains flexible and will not shrink. Bonds to metal, glass, ceramics, plastics, fibres and wood. Resists most solvents. Electrical insulator. Maximum constant operating temperature 250°C with neutral curing. Ensure surfaces are free from oil and grease.

STC4600

Hylomar 3400 Anaerobic Gasket Compound - 300ml

Excellent resistance to automotive fluids including fuels with an operating temperature -40°C to 150°C. Machined metal to metal surface only, not suitable for pressed steel. No gap filling. Latest generation anaerobic gasket compound. Single part product. Suitable for K-series engines. Ensure surfaces are free of oil and grease.



DA6441

Hylasil 100 Series Instant Gasket - 85g

Engineering grade amine curing RTC silicone sealant with a proven performance in aftermarket applications. Non corrosive. Forms any size or shape of gasket instantly. Remains flexible, will not shrink. Bonds to metal, glass, ceramics, plastics, fibres and wood. Resists most solvents. Electrical insulator. Ensure surfaces are clean and dry before use.

Bearing Grease



DA2391

Multi-pack of bearing grease 10 x 20ml sachets

Bulk Workshop Fasteners

Save time and effort with these packs of 100 of the more common Land Rover nuts and bolts.

251323X	Self locking nut x 100 7/16BSF P-Type zinc/clear
302532X	Special nut x 100
320045X	Floor screw x 100
509045PX	Propshaft bolt x 100 3/8 UNF x 1 1/8 x 3/4
79221X	Screw for door hinge x 100 Cone pointed UNF thread Drive screw x 100 14 x 3/4 pan posi AB S/T zinc/clear
AB614061LX	Plastic Rivet x 100
AFU1075X	Screw x 100
AFU1900X	Screw x 100
AM605061X	Acme bolt x 100 5/8 x 3/4 hex head
BX110095MX	Bolt - M10 x 45 patchloc x 100
BYH500100X	Nut & retainer x 100
FRC3602X	Bolt x 100 3/8 UNF x 1 1/2 hex head 3/8 thread
FS108207LX	Screw flanged head x 100 20mm long M8
FS108257LX	Bolt x 100 M8 x 25 flange hex head
FS108307LX	Screw x 100 M8 x 30mm 8.8 grade zinc clear
LR045409X	Bolt x 100 3/8 UNF x 1 1/8 x 3/4
MRC2178X	Nut & retainer x 100
MWC3136X	Snapsac x 100
MXC1800X	Fastener x 100
NH605041LX	Nut 5/8 UNF x 100
NY606041LX	Nut 3/8 UNF nyloc x 100
NZ606041LX	Propshaft nut x 100 3/8 UNF T-type nyloc



Got a great photograph of your Land Rover?

Why not enter the Britpart calendar competition for your chance to make your Landy a star. Full details can be found here - www.britpart.com/calendar



x100

Workshop Consumables

Workshop Fluids



Brake Fluids

SIJ500030	Brake fluid	500ml
SIJ500040	Brake fluid - Dot 4	1 litre

Coolants

Extended life coolant concentrate		
STC50529	Havoline	1 litre
STC50530	Havoline	5 litres

Engine Oils

DA1122	Castrol Edge Professional A1 5W-20	1 litre
Co-engineered in partnership with Land Rover for new engine applications. Over the full service interval it keeps the engine clean and provides outstanding fuel economy.		
DA6287G	Castrol Edge Professional C1 5W-30	1 litre
Proven in tests to deliver outstanding oil strength. Micro-filtered and with its signature fluorescent colour it is your guarantee of professional quality. It is suitable for use in automotive petrol and diesel engines where the manufacturer recommends an ACEA C1 5W-30 lubricant.		

Transmission & Drive Train Oils

STC50531LR	Automatic transmission fluid 402	1 litre
STC4861	Transmission fluid – transfer box	500ml
STC9157	LubeTech Manual transmission fluid 94 API GL4	5 litres
YVK000010	Gear oil - MTF94	1 litre
STC9158	LubeTech Manual transmission fluid 94 API GL4	1 litre
STC4862G	Texamatic 7045E	1 litre
Automatic transmission fluid. Provides top-tier protection to all applications where Dexron IILG type products are specified, offering excellent protection to automatic transmission and power steering systems.		
LR006247G	Castrol Syntrans 75W-90/API GL-4	1 litre
Multi-vehicle manual transmission fluid		
STC4863G	Mobile ATF LT 7141	1 litre
Automatic transmission fluid. Suitable for use in automatic transmissions and power steering systems.		
TYK500050G	ZF Lifeguard Fluid	1 litre
This high performance full synthetic oil for automatic transmissions has been exclusively developed and approved for ZF automatic transmissions only.		
YK500010G	Transfer Fluid TF-0870 - OEM	1 litre
Use in active transfer case to provide a stable viscosity.		

Transmission & Drive Train Oils - continued

TYK500010G	Castrol Differential SAF-XO SAE 75W-90	1 litre
Fully synthetic final drive lubricant recommended for most passenger car final drives.		
LR003156G	Castrol Differential EPX SAE 80W-90	1 litre
Mineral based multi-grade extreme pressure gear oil for the lubrication of spiral bevel and hypoid differentials. The product is also suitable for the lubrication of manual transmissions where the manufacturer recommends the use of an oil to API GL5.		
LR019727LR	Castrol Differential SAF Carbon Mod Plus SAE 75W-90	1 litre
Fully synthetic gear oil which can be used for axles with limited slip differentials.		
LR024835G	Castrol Syntrans FE 75W / API GL-4	1 litre
Multi-vehicle manual transmission fluid		

Anti-freeze

PDA500300	Anti-freeze	Land Rover	1 litre
PDA500310	Anti-freeze	Land Rover	5 litres

Cleaners

STC50543	General purpose/brake cleaner	Land Rover	200ml
STC50544	General purpose/brake cleaner	Land Rover	400ml
LR023889	Leather & vinyl cleaner - Contents - 1 x 150ml leather protection cream; 1 x 150ml leather soft cleaner & 1 x sponge and cloth		

Paints *Contains paint stick and clear lacquer

RTC6870VT	Touch up kit*	Land Rover	Alpine white
STC2864VT	Touch up kit*	Land Rover	Oxford blue
STC2828VT	Touch up kit*	Land Rover	Rioja red
STC1774VT	Touch up kit*	Land Rover	Epsom green
STC4235VT	Touch up kit*	Land Rover	Blenheim silver
STC4596VT	Touch up kit*	Land Rover	Oslo blue
STC2862A	Aerosol - 150ml	Land Rover	Monza red
RTC6401VA	Aerosol - 150ml	Land Rover	Windjammer blue

Miscellaneous

STC4676	De-icer	Land Rover	500ml
STC4672	Screen wash	Land Rover	250ml
STC9155	Specialised lubricant	Land Rover	250ml
STC50550	Gasket adhesive	Loctite 5980	100ml
STC50551	Flexible adhesive sealant	Terostat 8596	300ml
DA6296	Oil additive. Friction modifier for Haldex units.		850ml
STC50519LR	Power assisted steering fluid/ACE		1 litre

Dr. Tranny® Instant Shudder Fixx™

DA6809 2fl oz (59.2ml)
Packaged in a uniquely engineered two ounce application tube Dr. Tranny® Instant Shudder Fixx™ is compatible with conventional or synthetic automatic transmission fluids. This formulation of friction modifiers made of synthetics and synthetic esters is concentrated five times.

- > A concentrated friction modifier formulated specifically for instantly eliminating torque converter lock-up shudder
- > Provides 4x's less wear than regular ATF
- > The original shudder fix
- > Compatible with conventional and synthetic ATFs
- > Commonly used as a diagnostic tool to determine if a problem is fluid related or a more mechanical fix is required



Photo courtesy of Ben Cairns

Britpart XD Oils **NEW**

DA1331 NEW Britpart 10W-40 - 1 litre

Product Description

A semi-synthetic multi-grade engine oil meeting ACEA and API specifications required by a large number of cars and light commercial vehicles.

Engine design has changed rapidly over recent years. Increased output from smaller units coupled with reduced engine oil sump capacity has put greater demands on the lubricant.

Britpart 10W-40 is designed to meet these challenges and is manufactured from a balanced blend of top quality mineral and synthetic base stocks to produce a high quality engine oil with outstanding properties. Its naturally higher lubricity offers lower internal friction which reduces engine wear and improves fuel economy. It provides excellent stay in grade performance for a wide range of modern engines.

Benefits

- > Suitable for a wide range of vehicles
- > Stay in grade properties
- > Excellent high and low temperature stability
- > Improved oil consumption and emissions
- > Superior performance over standard mineral based oils

Applications

Britpart 10W-40 is suitable for normally aspirated and turbocharged highly stressed diesel and petrol engines in passenger cars and light commercial vehicles. It is miscible with all synthetic and mineral based engine oils.

XD oil

DA1333 NEW Britpart 5W-30 - 1 litre

Product Description

Britpart 5W-30 is a fully synthetic, fuel-efficient multi-grade engine oil approved to Ford specification WSS-M2C913-D and WSS-M2C913-C and meeting the STJLR.03.5003 Jaguar/Land Rover specification. Britpart 5W-30 is a fully synthetic multi-grade engine oil formulated with highly refined synthetic base stocks and the very latest in advanced additive technology. The carefully selected components combine to provide the user with improved fuel economy benefits, greater robustness to fuels containing increased levels of bio-diesel and superior soot handling properties. This highly stable, stay-in-grade product allows extended oil drain intervals to be achieved.

Benefits

- > Approved to Ford specification WSS-M2C913-D
- > Approved to Ford specification WSS-M2C913-C
- > Extended drain capability
- > Fully backwards compatible with the earlier specifications of WSS-M2C 913-A and 913-B
- > Stay-in-grade formulation
- > Excellent low temperature stability for improved flow rates
- > Improved fuel efficiency
- > Fully synthetic formulation

Applications

Britpart 5W-30 is an ideal choice in many normally aspirated and turbocharged petrol and diesel engines designed to use a fuel saving engine lubricant. In particular, Britpart 5W-30 can be used in all Ford diesel engines (except Ford Ka TDCi 2009 onwards and Galaxy 1.9 TDi 2000-2006). It is strongly recommended for use in Transit models (2012 onwards) carrying the 2.2 Duratorq TDCi engine where only WSS-M2C913-D lubricants can be used.

DA1331



DA1333



AdBlue Diesel Exhaust Fluid **NEW**



LR072258G NEW

4 x 1.89 litre (1/2 gallon) bottles

All new Euro 6 engines now have to have a diesel additive to reduce the emissions. The AdBlue liquid - called Diesel Exhaust System - does this and on new Land Rovers, they are using this more than expected, so there is a need for people to replace the fluid used. If the fluid runs out, the engine stops and won't restart without a visit to the Land Rover dealership. Previously this has only been available through Land Rover, now Britpart have the OE supplier product in stock.

Wet Clutch Oil **NEW**



DA1356 NEW

1 litre

This special fluid is developed for Borg Warner wet clutch applications and is suitable for use in wet clutches with sinter and organic plates. The oil provides excellent friction characteristics and prevents stick-slip. The extremely good shear stability properties ensures optimum lubrication during the life time of the clutch. This fluid is recommend for Borg Warner Generation II-V rear AWD coupling control unit clutches used in Land Rover. To the specifications of Land Rover EJ3219A509AA.



Photo courtesy of Pamela Blair

Ravenol Workshop Consumables

Engine Oils



DA6289 1 litre
DA6288 5 litres
SFE Super Fuel Economy 5W-20
 Ravenol SFE 5W-20 is suitable for all petrol and diesel engines requiring a 5w20 grade fuel economy lubricant, and is especially developed to meet the requirements of the latest generation of Land Rover and Jaguar vehicles fitted with 5.0L V8 units.



DA6291 1 litre
DA6292 5 litres
FO 5W-30
 Ravenol FO 5W-30 is a fuel economy engine oil, special product for modern gasoline and passenger car diesel engines.



DA6376 1 litre
DA6377 5 litres
FLJ SAE 5W-30
 Ravenol FLJ SAE 5W-30 is a universal, fuel-saving, specially-composed motor oil for modern petrol and diesel engines both with and without turbochargers, for use in automobiles and vans with extended oil change intervals.



DA6378 1 litre
DA6379 5 litres
VMO SAE 5W-40
 Universal synthetic low friction motor oil especially developed for pump-jet diesel engines. Moreover, this lubricant is suitable for gasoline and diesel engines in passenger cars and vans with and without turbo charger. Due to the specific composition Ravenol VMO SAE 5W-40 is suitable for use for several of the latest OEM requirements.



DA6368 1 litre
DA6369 5 litres
TSi SAE 10W-40
 TSi 10W-40 is suitable for year round use in modern petrol & diesel cars. For use in turbo & non-turbocharged vehicles, multi-valve & direct injection diesel engines and is catalyst-compatible. Due to the specific high quality composition of TSi 10W-40, meets and exceeds the requirements of many leading OEM's, it also carries manufacturer approvals.



DA6380 1 litre
DA6381 5 litres
Turbo-C HD-C SAE 15W-40
 It is perfectly suited as all-season motor oil for the mixed fleet. It can be used in the commercial vehicle sector for operation and extended oil change interval (up to 45,000 kilometres are possible) according to manufacturer's specifications.

Transmission Oils



STC4863 1 litre
ATF 5/4 HP Fluid
 Ravenol ATF 5/4 HP Fluid is primarily designed for use in ZF 4HP-series (4HP20, 4HP22, 4HP24) and 5HP-series (5HP18, 5HP19, 5HP24, 5HP30) automatic transmissions.



STC50531 1 litre
ATF JF506E Fluid
 Ravenol ATF JF506E is primarily designed for use in JATCO JF506E 5-speed automatic transmissions used in Land Rover Freelander.



TYK500010 1 litre
TYK500010-20L 20 litres
VSG 75W-90 Gear Oil
 Ravenol VSG 75W-90 is suitable for use in both synchromesh and non-synchromesh gearboxes as well as being perfectly suited for use in highly stressed axle drives and differentials. Used in many high performance and motorsport applications as well as for road use in cars, light commercials and trucks where maximum protection and fuel economy are desired.



TYK500030 1 litre
MTF-2 75W-80 Gear Oil
 Ravenol MTF-2 SAE 75W-80 is ideally suited to ensure smooth and efficient operation of modern transmissions subject to very high mechanical and thermal loads of gear oils, even at the longest oil change intervals.



TYK500050 1 litre
TYK500050-4L 4 litres
TYK500050-20L 20 litres
ATF 6HP Fluid
 Ravenol ATF 6 HP Fluid was developed specifically for use in the latest ZF 6HP-series transmissions, 6HP19, 6HP21, 6HP26, 6HP28, 6HP32, 6HP34, also for 5-speed automatic transmission 5HP-series. It is backwardly compatible for all earlier versions of ZF 4.



IYK500010 1 litre
IYK500010-20L NEW 20 litres
Transfer Fluid TF-0870
 Ravenol Transfer Fluid TF-0870 was developed for use in active transfer case and provides a stable viscosity even under the highest loads.



DA6374 1 litre
DA6375 4 litres
Ravenol ATF T-WS Lifetime Fluid
 An automatic transmission fluid based on the latest HC/HT and PAO synthetic technology. Due to the special formulation the durability is up to twice that of a comparable standard ATF oil.



DA6372 1 litre
DA6373 4 litres
Ravenol ATF Dexron D II
 It was developed for the use in automatic transmissions, hydro steering mechanisms, converters and power transmissions and can be used as a universal ATF (Automatic-Transmission-Fluid) for all vehicles and working machines.



LR002748 1 litre
ATF T-IV Fluid
 Ravenol ATF T-IV Fluid was primarily developed for use in the latest Aisin Warner and Toyota transmissions found in many modern European and Japanese vehicles, and it's versatile formulation means it can also be used to replace older T, T-II and T-III fluids where required, as well as fulfilling many other manufacturer requirements.



STC4862 1 litre
ATF Dexron III H
 Ravenol ATF Dexron III H was primarily developed for use in automatic transmissions with electronically controlled converter lockup clutch, but also suitable for use as a universal ATF and power steering fluid, especially where Dexron III is the required specification, and is backwards compatible for Dexron II applications.



LR003156 1 litre
EPX SAE 80W-90 GL
 Ravenol Getriebeoil EPX SAE 80W-90 GL 5 is compatible with all brand-name transmission oils. In case of changing to Ravenol EPX SAE 80W-90 GL 5 flushing is not necessary. It can be used in manual transmissions, axle drives, distributor and intermediate transmissions in vehicles and working machines.



LR019727 1 litre
Multi-disc Locking Differentials Semi-synthetic Lubricant
 Ravenol MDL multi-disc locking differentials was developed specifically for use in lamella limited slip differentials.

Transmission Oils - continued



DA1345 NEW 20 litres
Ravenol ATF 8HP
 Ravenol ATF 8HP Fluid is an automatic transmission fluid (ATF), produced with a blend of hydrocrack oils and synthetic PAO together with special additives and inhibitors to enable smooth and efficient function of the latest ZF automatic transmissions. Ravenol ATF 8HP Fluid has been formulated specifically for the latest generation of 8-speed ZF automatic transmissions and is coloured green for easy identification.



Coolants

DA6293 1.5 litres
DA6294 5 litres
OTC Organic Technology Coolant Concentrate
 Ravenol OTC Organic Technology Coolant Concentrate is an eco-friendly 1.2- Ethanediol (monoethylene glycol) based silicate, borate, nitrite and phosphate-free coolant for cooling circuits in combustion engines which provides maintenance-free corrosion and frost protection.



Grease

DA4960 400g
DA4961 5kgs
Ravenol Multi-purpose Grease
 Ravenol Mehrzweckfett OML is a lithium based multi-purpose grease with oxidation and corrosion protective additives.

Power Steering



STC50519 1 litre
STC50519-20L 20 litres
SSF Power Steering Fluid
 Ravenol SSF Fluid is a special hydraulic fluid formulated using the latest synthetic technology blended with special ashless additives. It is designed for use from -40°C to +100°C and is therefore recommended for the latest developments in the vehicle market. Ravenol SSF Fluid is a special hydraulic fluid formulated using the latest synthetic technology blended with special ashless additives.

Oil Analysis Kit



DA6358 Oil Analysis Kit
 Extend the life of both engine and transmission...
 Lubetrend Analysis is the complete fluid analysis programme performed by the Number One oil condition monitoring laboratory in the UK with over 35 years of experience in monitoring all types of fluid lubricated and insulating oil systems; giving you the confidence to act.
 Regular checks on the condition of the oil can extend the life of both engine and transmission and help spot potential problems long before they materialise. Our aim is to help you succeed in making the most of your vehicles and machinery through reducing unplanned downtime, extending oil drains and detecting potential future failure - before they happen. Essential not only for all aspects of motorsport - we'd recommend taking a sample after each event - but also recommended for your everyday transport as part of the annual service.
 The price includes the sample kit and the full analysis report. Only the postage to the laboratory is your responsibility.

Diesel System Cleaner



DA4962 300ml
Ravenol Diesel System Cleaner
 A fuel additive for all diesel engines which cleans the fuel injection system and restores the full power of the engine, whilst increasing operational safety and improving fuel economy. It is a cleaning agent for electronically and mechanically controlled fuel injectors which allows for combustion with a low degree of soot and reduced particles whilst preventing rattling noises and rough idling.

Much more information on each of these Ravenol products at www.britpart.com/ravenol

Ravenol the renowned German Manufacturer is one of the most technically innovative companies in the lubricants industry. Ravenol prides itself on the special formulations, unique design and its exacting manufacturing processes that are individually tailored to suit customer needs. This is why the demand for Ravenol product is growing worldwide.

In the advanced in-house laboratories products are carefully developed to meet and exceed the requirements of the major automotive manufacturers and to comply with all current and future regulations. Across the globe, Ravenol has earned an enviable reputation for innovation and technical excellence.

Ravenol have developed an extensive range of products meeting and exceeding Land Rover requirements resulting in quieter running engines with improved fuel economy and smoother gear changes. Whichever Land Rover/Range Rover model you drive, wherever and however you drive it, Ravenol have developed a lubricant to meet your specific requirements.

We at Britpart not only recommend the use of Ravenol lubricants in your Land Rover, but use them in our own fleet of Land Rovers, trucks and vans.



Sundries



DA6485 Brake Cleaner 500ml
 Ravenol brake cleaner is a highly effective solvent-blended brake cleaner aerosol for the degreasing and cleaning of brakes, brake linings and clutch parts.



DA6486 Silicone Spray 400ml
 Ravenol Silicone-Spray is a universal lubricant and slide release agent spray for use on all types of components. Specially developed for the lubrication, care and maintenance of all types of rubber, plastic and metal surfaces and components. The water-resistant and weatherproofing properties make it especially suitable in a marine environment. The quick drying formulation leaves a colourless and odourless coating which is physiologically inert, water-resistant, UV-resistant and weatherproofed.



DA6496 Copper Paste 90g
 Ravenol Copper paste is a lithium grease containing copper powder as a solid lubricant additive, anti-wear additives, and anti-corrosion properties. It is suitable for application to components which are exposed to high temperatures, strong pressures and corrosive influences. It reduces friction and wear, provides protection against corrosion and seizing and is used in the automotive industry for assembling disc brakes and exhaust systems.

Castrol Classic Oils

Castrol Classic Oils, total care and protection for your classic vehicle.

For much more information on each product and images visit www.britpart.com/castrol

A conventional multi-grade engine oil of good all round performance for pre-1980 modern classic cars.

DA6260 Classic XL 20W-50 1 gallon tin
DA6261 Classic XL 20W-50 1 litre tin

Mineral based, multi-grade, crankcase lubricant. Designed to facilitate running-in of new and reconditioned diesel and petrol engines.

DA6262 Running In Oil No. 2 1 gallon tin
 Castrol R40 provides the ultimate in lubrication.

DA6263 R40 1 litre bottle
 Originally specified grade for Series steering boxes and relays.

DA6264 EP140 Extreme Pressure API GL4 1 litre tin
 Extreme pressure multi-purpose gear oil for hypoid and non-hypoid applications.

DA6265 EP90 Extreme Pressure API GL4 1 litre tin
 Lead replacement fuel additive for use with lead-free fuel. Protects engine against valve seat recession under all driving conditions.

DA6266 Valvemaster Lead Replacement Additive 250ml bottle
 Castrol Valvemaster Plus provides an octane boost to unleaded fuel, reducing pinking, knocking or the need to retune.

DA6267 Valvemaster Plus Octane Boost 250ml bottle
 Transmission fluid for automatic gearboxes, incorporating additives to provide wear, oxidation and corrosion resistance.

DA6268 TQF 1 litre tin
 A special, rubber compatible grease for use on hydraulic brake and clutch components where hardening or swelling of rubber must be avoided. Useful in assembly of rubber components for brake, clutch and suspension units.

DA6269 Red Rubber Grease 500g pot



Castrol Classic Oils Merchandise

Drink your tea in a nostalgic way with this large tin mug.

DA6270 Castrol Tin Mug

Use either to decorate your workshop or study or to accurately measure lubricant quantities shown in imperial measures in vehicle handbooks.

DA6271 Castrol Pouring Jug Half pint

DA6272 Castrol Pouring Jug Pint

DA6273 Castrol Pouring Jug Quart (two pints)

Smart green baseball cap with embroidered Castrol logo.

DA6274 Baseball Cap One-size fits all

Never forget to change your oil with this self-cling window sticker with Castrol logo on one side and Change Due boxes on the other.

DA6275 Window Service Sticker 3" diameter



Photo courtesy of Edwin Remsberg

Ravenol Classic Oils



DA4963
 5 litres
Ravenol Classic SAE 30
 Monograde engine oil for pre-1960 Land Rovers.



DA4964
 5 litres
Ravenol Classic SE 20W-50
 Multi-grade engine oil for post 1960 petrol Land Rovers.



DA4965
 1 litre
Ravenol MZG EP 80W-90 GL4
 Transmission oil for early Land Rover gearboxes, transfer boxes and differentials. Recommended for the lubrication of all manual transmissions, differential gears, transfer boxes and steering boxes of most early Land Rovers where a GL4 specification is called for.



DA4966
 300ml
Ravenol Octane Booster
 Petrol engine lead replacement additive with octane booster. An environmentally-friendly valve seat lubricant and combustion enhancer which increases the octane rating by at least 3 points. It helps to prevent pinking and running on and allows more ignition advance, thus improving performance in the peak ranges. Especially suitable for low-grade or insufficient fuel quality. It helps to prevent wear and tear on valve seats and exhaust valves when using modern fuels in older engines.

The need for Classic Oils?

Oils for modern engines need to comply with the latest API ratings and specific ACEA and OEM specifications concerned with improving fuel efficiency, extending oil drain intervals and exhaust treatment systems such as diesel particle filters.

A classic car engine has the opposite characteristics with cork/graphite/rope seals, low pressure gear driven oil pumps, larger oil galleries with greater dependence on "splash" and "cling" lubrication, lower revving with larger machining tolerances. This type of engine design demands a totally different lubricant. The new range of Ravenol Classic Oils offers formulations that have been specially blended to meet the requirements of older vehicles.

Special anti-wear additives with the correct amount of zinc (ZDDP) are added to ensure that metal to metal contact and irreparable engine damage is prevented, especially to camshafts and followers, which can wear out in only a few thousand miles when using modern oils. The careful selection of appropriate corrosion inhibitors, special dispersant additives and the correct levels of detergent protect against pitting, the build-up of gums, lacquers, sludge, soot and metallic ash – the normal by-products of combustion.

By using Ravenol Classic Oils in your classic Land Rover you are protecting both engine and transmission – for generations to come.



www.britpart.com/ravenol

Raptor

RAPTOR

- DA6382** Raptor 4 litre kit - black finish
4 x 750ml Raptor & 1 x 1 litre hardener
- DA6497** Raptor 1 litre kit - black finish
1 x 750ml Raptor & 1 x 250ml hardener
- DA6370** 1 x 5 litres of black Raptor
- DA6384** Raptor 4 litre kit - tintable finish
4 x 750ml Raptor & 1 x 1 litre hardener
- DA6498** Raptor 1 litre kit - tintable finish
1 x 750ml Raptor & 1 x 250ml hardener
- DA6436** 1 x 5 litres of tintable Raptor
- DA6371** 1 x 5 litres of Raptor hardener

Degreaser Slow

- > Anti-static and anti-silicone panel wipe.
- > Fast evaporation ideal for localised panel repairs.
- > Aggressive degreasing action removes contaminants including silicones.
- > Carefully formulated to avoid any attack on existing paint films.

- DA6390** 1 litre tin
- DA6391** 5 litre tin
- DA6392** 500ml aerosol

ACID#8™: Acid Etch Primer

- > Promotes paint adhesion to difficult substrates such as galvanised steel & aluminium.

- DA6393** 450ml aerosol

GRIP#4™: Universal Adhesion Promoter

- > Ready for use universal adhesion promoter for paints, adhesives and sealants.
- > Ideal for difficult to reach areas such as around door handles and sills.
- > Replaces the need for abrasion and prevents lifting.

- DA6394** 450ml aerosol

Raptor Traction

- > Slip resistant additive
- > 1 sachet needed for 1 litre Raptor
- > BSI Kitemarked

- DA6484** 200g sachet

Finishing Pads

- > High performance cleaning, conditioning & finishing pad.

- DA6395** 10 x Fine pads

Panel Wipe Cloths

- > White wipe that leaves the surface clean, completely grease & fibre-free.

- DA6396** 140m roll with 350 sheets in convenient centre-feed box dispenser.

Mixing Cups

- > Clear plastic 1,300ml mixing cups

- DA6397** 25 qty

Wooden Mixing Spatulas

- DA6398** 100 qty

Schutz Gun

- > Specially constructed for the application of Raptor.
- > Screws directly onto plastic bottle.

- DA6386** Raptor application gun

Gravity Fed Spray Gun

- > 1.7 tip with excellent transfer efficiency

- DA6447** Professional automotive spray gun

TOUGH & TINTABLE protective coating

Raptor is a highly durable protective coating that ensures protection against mechanical damage, fuels, hydraulic oils, rust, corrosion, salt water, damp, extreme temperatures and off-road muddy good fun.



Protect your Land Rover with Raptor

Surfaces*

- > Painted surfaces
- > Aluminium
- > Steel
- > Bare metal
- > GRP
- > Galvanised
- > Plastics
- > Wood
- > Polyester fillers
- > Glass
- > SMC

Usage

- > Automotive
- > Off-road
- > Marine
- > Commercial
- > Industrial
- > Agricultural

*Some substrates require additional surface preparation before applying Raptor.

Customisable

Raptor is available in black and tintable versions. The tintable version can be altered to suit the colour of your vehicle by adding a small amount of automotive solvent paint. Raptor can be applied as a smooth finish through to a very coarse finish.

Features & Benefits

- > Easy to use: simply FILL - SHAKE - SHOOT®
- > Easy to clean
- > Provides excellent UV protection
- > Waterproof - provides a water tight seal, keeping water out and protects new surfaces against rust
- > Sound deadener (reduces noise and vibrations)
- > Protects against rust, corrosion salt, damp and extreme temperatures
- > High resistance to everyday and off-road use
- > Abrasion and stain resistant
- > Dries rapidly, is flexible
- > Provides excellent adhesion
- > No need to wax after application

Application Areas

- > Chequer plate and grills
- > Loading area
- > Underbody protection
- > Bumpers and bull bars
- > Sills, side rails and steps
- > Wheels and wheel arches
- > Part and full vehicle overspray
- > And much more...

Application Methods

- > Raptor application gun
- > Roller
- > Brush



Watch online how easy it is to use at

www.britpart.com/raptor



One half of this Discovery 1 corner bumper is a very tired looking, tatty and weather beaten bit of plastic. The other half is transformed with a coating of Raptor and it will stay like this as Raptor is UV resistant.

For full product details and a video to see how easy it is to use visit

www.britpart.com/raptor

Isopon Repair Consumables **NEW**



DA6604 NEW

Body Repair Kit For Holes

This kit contains everything you need to repair and prime rust holes (up to 75mm wide) in most types of metal ready for painting.

Much more information available
www.britpart.com/isopon

DA6605 NEW

Plastic Bumper Repair Kit

This kit contains everything you need to repair and prime scratches and scuffs in most types of plastic. The pre-measured sachets make mixing simple and it can be easily sanded and shaped to the exact bumper contour. Highly flexible with excellent adhesion, the filler gives a smooth durable repair that's ready for priming and painting.

DA6609 NEW

Scratch & Stone Chip Filler

A durable easy to use filler that's been specially formulated to repair fine scratches, stone chips and other minor damage. Used straight from the tube, it dries fast and is easy to sand smooth ready to prime. Just follow the simple instructions in this guide for a quick and easy repair.



DA6608 NEW

Body Filler For Holes

Fibreglass reinforced P.40 body filler for holes is the ideal choice for repairing holes up to 75mm wide in most types of metal. The pre-measured tubes make mixing easy and it can be used with the aluminium mesh to bridge larger holes.

DA6607 NEW

Plastic Bumper Filler

A flexible easy to use filler that's been specially formulated to repair scratches and scuffs in most types of plastic. The pre-measured sachets make mixing simple and it can be easily sanded and shaped to the exact bumper contour. Highly flexible with excellent adhesion, the filler gives a smooth durable repair that's ready for priming and painting.

DA6606 NEW

Stone Chip Protector

Long lasting protection from stone chips and rust. Can be over-painted. Specially formulated to protect sills, side skirts and the underside of vehicles from stone chips and rust. The black, quick drying spray formula is fast, easy to use and gives long lasting protection with just two coats.



DA6276 NEW

Metalik Paste

Long recognised as one of the only body fillers that will adhere to a Land Rover's aluminium body. A two component multi-functional smooth metallic body filler paste used for the filling of holes & imperfections in most substrates. It has been specially formulated for the professional user and combines good filling and smooth spreading properties together with ease of sanding. Metalik Paste is suitable for use on the following surfaces; bare metal, eg steel aluminium and zinc coated substrates (degrease and abrade with P80 paper), original painted surfaces (with the exception of thermoplastic acrylics - degrease and abrade with P180 paper) and GRP (degrease and abrade with P80 paper). 2K polyester body filler contains aluminium flakes and is smooth spreading with good adhesion & pinhole free. Sandable after 20 minutes (at 20C) and can be over-painted with most paint systems including 2K.



Photo courtesy of Irah Shilling

Dinitrol Products

These rustproofing kits are designed for those who don't have access to a compressor or air supply.

DA1985 NEW

Rust Proofing Aerosol Kit - Large Car

- 7 x Dinitrol 3125 Cavity Wax - 500ml aerosol
- 10 x Dinitrol 4941 Black Underbody Wax - 500ml aerosol
- 1 x Dinitrol RC900 Rust Converter - 400ml aerosol
- 2 x 600mm Extended nozzle for aerosols
- 50 x 10mm Black tapered plastic plugs
- 1 x Aerosol application trigger attachment

DA1986 NEW

Rust Proofing Aerosol Kit - Land Rover

- 7 x Dinitrol 3125 Cavity Wax - 500ml aerosol
- 5 x Dinitrol 445 Black Stone Chip - 500ml aerosol
- 5 x Dinitrol 4941 Black Underbody Wax - 500ml aerosol
- 1 x Dinitrol RC900 Rust Converter - 400ml aerosol
- 2 x 600mm Extended nozzle for aerosols
- 50 x 10mm Black tapered plastic plugs
- 1 x Aerosol application trigger attachment

DA1989 NEW

Rust Proofing Aerosol Kit - New Vehicle

- 7 x Dinitrol 77B Brown Cavity Wax - 500ml aerosol
- 5 x Dinitrol 445 Black Stone Chip - 500ml aerosol
- 5 x Dinitrol 4941 Black Underbody Wax - 500ml aerosol
- 1 x 600mm Extended nozzle for aerosols
- 50 x 10mm Black tapered plastic plugs
- 1 x Aerosol application trigger attachment

These rustproofing kits are designed for those who have access to a compressor or air supply and includes an undercoating gun for easy application.

DA1987 NEW

Rust Proofing Litres kit - Large Car

- 4 x Dinitrol 3125 Liquid Cavity Wax - 1ltr bottle
- 6 x Dinitrol 4941 Black Underbody Protect 1ltr bottle
- 1 x Dinitrol RC900 Rust Converter - 400ml aerosol
- 1 x Shutz Gun
- 50 x 10mm Black tapered plastic plugs
- 1 x 600mm Extended nozzle for aerosols

DA1988 NEW

Rust Proofing Litres Kit - Land Rover

- 4 x Dinitrol 3125 Liquid Cavity Wax - 1ltr bottle
- 3 x Dinitrol 445 Black Stone Chip - 1ltr bottle
- 3 x Dinitrol 4941 Black Underbody Protect - 1ltr bottle
- 1 x Dinitrol RC900 Rust Converter - 400ml aerosol
- 1 x Shutz Gun
- 50 x 10mm Black tapered plastic plugs
- 1 x 600mm Extended nozzle for aerosols

DA1990 NEW

Rust Proofing Litres Kit - New Vehicles

- 4 x Dinitrol 3654 ML4 Cavity Wax - 1ltr bottle
- 3 x Dinitrol 445 Black Stone Chip - 1ltr bottle
- 3 x Dinitrol 4941 Black Underbody Protect - 1ltr bottle
- 1 x Shutz Gun
- 50 x 10mm Black tapered plastic plugs

DA1986



NEW

DA1988

DA1983 NEW

600mm extended nozzle for aerosols. Ideal for applying the Dinitrol products.

DA1983

For much more information on each of the Dinitrol products in each kit and the technical data sheets -

www.britpart.com/dinitrol



DA1980

1 litre

Dinitrol 449 is an environmentally friendly bitumen based underbody and stonechip coating with good corrosion protection and sound deadening properties. After curing Dinitrol 449 has a very durable tough and elastic film, which results in a very good stonechip resistance. The product is not overpaintable.

- > Waterbased, environmental friendly
- > No VOC
- > Good corrosion resistance
- > Very good stone chip resistance
- > Durable tough elastic film



DA1981

1 litre

Dinitrol 977 is a semi-transparent, waterbased liquid anti corrosion coating for the protection of cavity areas in places where a rust preventative surface is needed. The product is water-repellent and has very good penetrating properties. After drying remains a wax coating which has a good temperature resistance up to +120°C and is almost tack free. When Dinitrol 977 is heated by sun or by engine-heat after it has dried, it does not have the typical smell of conventional cavity-waxes.

- > Waterbased, environmental friendly
- > Very low VOC
- > Good corrosion resistance
- > Good penetration
- > Low odour
- > Film almost tack free



NEW

DA1982 NEW

1 litre

Dinitrol 77B is a corrosion preventive fluid, designed for long-term protection against corrosion and, due to its residual hard film affords some protection against mechanical wear. Dinitrol 77 B contains environmentally acceptable low aromatic solvents, which once evaporated leaves a thick, brown waxy film. Dinitrol 77B is primarily designed for cavity protection but may also be used for storage, transport and underbody protection.



Photo courtesy of Simon Clarke

Loctite Consumables



The Loctite® brand, is renowned for the excellence of its adhesives and sealants. Since the original development of a unique anaerobic technology more than fifty years ago, Loctite® products have become vital components in many of the machines and products that are at the core of everyday life

Body Repairs

DA6310	Freeze & Release	400ml aerosol
Shock freezing (-43°C) is a quick and convenient method for releasing seized and corroded parts.		
DA6278	Chemical Metal NEW	180ml pack
The original rock-hard multi-purpose repair paste.		
DA6313	Leak Fix	Mini blister pack
Seals and repairs leaks in petrol tanks, radiators and sumps.		
DA6316	Terodicht Elastic Window Sealant	310ml cartridge
Ideal for re-sealing rubber mounted windscreens.		
DA6317	Terolan Special Sealant	1.4kg can & brush
Vehicle body sealant for application with special brush.		
DA6319	Terosan Etch Primer	500ml aerosol
Provides excellent adhesion to steel, galvanised steel and aluminium.		
DA6326	Zinc Spray	400ml aerosol
Sprayable anti-corrosion primer paint for vehicle body repairs. Electrically conductive (wet and dry). Allow to cure for 8-12 hours before over painting.		
DA6327	Terotex HV 350	1 litre bottle
A solvent containing anti-corrosive agent based on waxes, polymers and anti-corrosive additives. Contains high percentage of rust-proofing additives. Good creeping qualities. Penetrates to a depth of >35mm. Mild odour.		
DA6328	Terotex Record 2000	1 litre bottle
Non-bituminous coating material for permanently flexible corrosion protection of under bodies. To complement factory-applied under body sealant coats. For coating replacement parts like bumpers or wheel arches.		

Glues & Adhesives

DA6300	Super Glue	3g tube
High performance instant adhesive with thousands of applications.		
DA6301	Super Glue Brushable	5g bottle
Brushable version for extra accuracy and greater coverage.		
DA6304	Rear View Mirror Bonder	1 shot tube
Unique bonding system for rear view mirrors, car telephone aerials and all window mounted material.		
DA6306	Stud 'N Bearing Fit	24ml bottle
Locks and seals studs into position. Seals against leaks and vibration.		
DA6309	Instant Adhesive 401	20g tube
Surface insensitive formulation creates a permanent bond with virtually any material.		
DA6314	Super Steel Epoxy-Weld	2 x 25g tube
Sets like steel. Seals, repairs, bonds, fixes and replaces.		

For more information and images on our range of Loctite products visit www.britpart.com/loctite

Gasket Repairs (see website for full application details & technical specifications)

DA6311	Quick Gasket	200ml aerosol
Permanently flexible flange sealant for non-rigid flanges and for plastic-to-plastic and metal-to-metal assemblies.		
STC50550	Premium Silicone Black 5980	100ml tube
For flanges with permanent oil contact. Can be used for metal, plastic and painted parts. Low odour, non corrosive.		
DA6364	Premium Silicone Grey 5660	100ml tube
For flanges with permanent water/glycol contact. Can be used for metal, plastic and painted parts. Low odour, non corrosive.		
DA6365	Premium Silicone Copper 5990	100ml tube
For flanges exposed to high temperatures and high performance engines. Can be used for metal, plastic and painted parts. Low odour, non corrosive.		
DA6366	Silicone Blue 5926	40ml tube
Multi purpose flexible silicone sealant. For flanges of any size or shape. Can be used for metal, plastic and painted parts.		

Thread Lockers

Lock 'N Seal 243. Replaces traditional locking methods. Prevents bolts, screws & nuts from vibrating loose.
STC50552 - 10ml bottle / **DA6305** - 24ml bottle / **DA6307** - 50ml bottle



Touch Up Paint Pens

The best you can get without repainting!



Exclusive to Britpart in the UK.



- > TUPP single stage paint pen is ergonomic, light and easy to use.
- > It allows quick, one-step repairs of small scratches and nicks that may appear on any painted surface.
- > It will meet the highest colour matching expectations.
- > The patented valve mechanism and gravity action of the paint pen will give you an even flow of all components assuring the same particularities and brightness of the original finish.
- > An edged polyester fibre tip allows accuracy and can be removed to be cleaned or replaced.
- > The paint pen has a closed opaque container preventing accidental spills, hardening of the paint and colour change due to light exposure before the application.

The Pen - Paint is held in a barrel and automatically dispensed through a fine felt tip, providing the user unparalleled control over their painting instrument.

The Paint - High quality urethane paint is used which is the same as your vehicles manufacturer. The paint provides the user with a much closer colour match than other companies which primarily use lacquer paints.

The Results - The best you can get without refinishing the damaged areas.

More details and FAQs can be found at www.britpart.com/paintpens

Part Number	Colour	Code(s)	Part Number	Colour	Code(s)	Part Number	Colour	Code(s)
DA6217	Adriatic Blue	731	DA6471	Chile Metallic	944 (CAS)	DA6483	Nara Bronze	825 (AAJ)
DA6461	Aintree Green	866 (HGY)	DA6244	Cobar Blue	624 (JAV)	DA6228	Narvik Black	921
DA6237	Alaska White	909	DA6481	Colima Lime	829 (HAQ)	DA6240	Niagara Grey	574
DA6454	Aleutian Silver	835 (MMC)	DA6467	Corris Grey	873 (LKH)	DA6473	Orkney Grey	949 (KJZ)
DA6202	Alpine White	456 (NUC)	DA6204	Epsom Green	961	DA6213	Oslo Blue	644
DA6212	Alveston Red	696	DA6478	Estoril Blue	998 (JAE)	DA6205	Oxford Blue	602
DA6226	Arctic Frost	962	DA6463	Firenze Red	868 (CAH)	DA6201	Portofino Red	390 (CUF)
DA6476	Aruba Metallic	995 (GAT)	DA6462	Fuji White	867 (NDH)	DA6227	Rimini Red	889
DA6223	Atacama Sand	916	DA6218	Giverny Green	734	DA6206	Rioja Red	601 (CAQ)
DA6233	Atlantis Blue	632 (JYW)	DA6460	Havana	865 (AAN)	DA6207	Rutland Red	607
DA6468	Baltic Blue	912 (JEB)	DA6232	Icelandic Blue Mica	621 (JEL)	DA6259	Santorini Black	820
DA6457	Barolo Black	861 (PEH)	DA6458	Indus Silver	863 (MEN)	DA6470	Scotia Grey	943 (LAZ)
DA6465	Barossa Pearl	871 (KEB)	DA6242	Ipanema Sand	GAQ	DA6482	Siberian Silver	834 (MBP)
DA6230	Belize Green	756	DA6211	Java Black	697	DA6234	Silver Sparkle	MNH
DA6200	Beluga Black	416 (PUE)	DA6477	Kaikoura Stone	997 (BAG)	DA6235	Stornoway Grey	907 (LEL)
DA6236	Biarritz Blue	965	DA6239	Kent Green	647	DA6455	Tamar Blue	817 (JMC)
DA6245	Blenheim Silver	642	DA8044	Keswick Green	799 (HFU)	DA6238	Tangiers Orange	761
DA6214	Bonatti Grey	659	DA6231	Kinver Sand	609 (EAB)	DA6222	Tonga Green	904
DA6243	Borrego Yellow	757 (FUQ)	DA6469	Loire Blue	942 (JBM)	DA6224	Vesuvius Orange	811
DA6203	British Racing Green	617	DA6241	Lucerne Green	966	DA6215	Vienna Green	751
DA6220	Buckingham Blue	588 (796)	DA6464	Luxor	869 (GAA)	DA6208	White Gold	618
DA6221	Cairns Blue	849	DA6456	Mariana Black	860 (PEL)	DA6209	Woodcote Green	623 (HPE)
DA6229	Caledonia Blue	507 (JUT)	DA6480	Marmaris Teal	826 (JCK)	DA6479	Yulong White	2201 (NAK)
DA6474	Causeway Grey	950 (LNL)	DA6459	Mauritius Blue	864 (JYN)	DA6216	Zambezi Silver	737
DA6472	Chablis Green	945 (MMD)	DA6219	Maya Gold	846	DA6466	Zanzibar Brown	872 (EAR)
DA6210	Chawton White	603	DA6475	Montalcino Red	952 (CAX)	DA6225	Zermatt Silver	798



Photo courtesy of Ronny Jacobsen

Calibration Tools



LRT-60-003

Air suspension calibration blocks for Range Rover P38. To be used in conjunction with Lynx diagnostics kit.

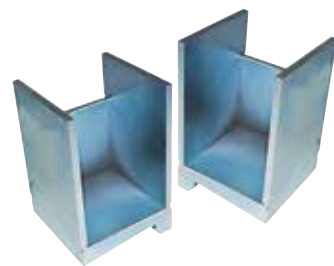

LRT-64-003

Air suspension calibration blocks for Discovery 2. To be used in conjunction with Lynx diagnostics kit.

Timing Tools



DA1115

Timing kit
Freelander 2 - 2.2 diesel
Land Rover tool part numbers -
303-1277 - Camshaft pulley timing pin
303-1270/303-1059 - Flywheel locking
timing pin
303-1272 - Flywheel/ring gear locking tool
adaptor



DA1116

Timing kit
Discovery 3 - 4.4 V8 - from 2005
Range Rover Sport - 4.2 V8 Supercharged
- up to 2010 & 4.4 V8 up to 2010
Range Rover L322 - 4.2 V8 Supercharged -
2005 - 2010 & 4.4 V8 - 2005 - 2010
Jaguar 4.2 & 4.4 V8 engines with codes
4PN & 428PS



DA1121

Timing tool kit for Land Rover KV6 engines
The Land Rover KV6 quad cam engine
has one front and two rear camshafts and
these tools cover the replacement of all
three belts



DA1120

Flywheel locking tools
& camshaft timing pins
Discovery 3 - 2.7 TdV6
Range Rover Sport - 2.7 TdV6



DA6120

Fuel pump locking tool for use with DA1120
on 3.0 TdV6 engines.



DA1162

Flywheel locking tool
Defender - 2007 onwards
Land Rover tool part number - 303-698



DA3140

Timing kit - 2.5D/Tdi - 12 piece



LRT-12-158

LRT-12-058

LRT-12-058

Timing pin (short) - Td5

LRT-12-158

Timing pin (long) - Td5



DA6116

Freelander TD4 - M47 - 200002
Range Rover L322 - Td6 - 2000 - 2006
This set enables the correct timing to be
made when servicing the BMW M47 2.0 16
engines.



DA6124

Range Rover Sport - 3.6 TdV8
Range Rover L322 - 3.6 TdV8
Designed to lock the camshaft and
crankshaft in their timed position when
performing engine rebuild or changing the
cam chain. Packed in a foam tray and metal
tin. Made in Sheffield.
Components are equal to
OEM 303-1236 - camshaft alignment blocks
2 x 2 + bolts
303-1243 - flywheel locking plate
303-1239 - camshaft rotating pin
303-1238 - crankshaft timing pin



DA6129

Range Rover P38 - BMW diesel
Specifically designed for the 2.5 TDS
diesel engines. This timing tool includes
crankshaft holding tool, timing chain
compressor, injection pump puller, shaft
puller, crankshaft alignment pin, camshaft
alignment tool & tensioner locking pins.



DA6112

Defender - 2.4 TDCi
Timing tool kit including timing pump
removal and installation tools, camshaft/
crankshaft sprocket alignment pin, chain
tensioner, fuel pump cover removal tool
and fuel injection pump sprocket locking
tool. Supplied in metal case with foam tray.



Photo courtesy of Sebastien Fiastre

Sockets & Spanners



606435
Hub nut spanner



DA1118
52mm deep socket - 1/2" drive
Socket for adjusting hub nuts
Defender/Series



DA1111
Viscous fan coupling spanner
Two sizes - 32 & 36mm



LRT-12-094
Viscous fan coupling wrench
V8 petrol/Td5 diesel/V6 2.7 diesel
2.5 Td diesel/Td6 diesel/300Tdi



LRT-12-093
Viscous coupling holding tool
V8 petrol/Td5 diesel/2.5 Td diesel/300Tdi



Oil Filter Tools



DA1117
Td5 oil filter spanner



DA6118
Oil filter socket
Freelander 2
Range Rover Evoque 2.2 diesel
27mm hexagon face drive with 3/8" D
face drive. Removes paper filters without
damage to the plastic filter housing.
Manufactured from Chrome Vanadium.



DA1176
36mm oil filter socket - 3/8" drive
Designed to protect the corners of the filter
from damage. Defender - Puma 2.2 & 2.4
Freelander 1 - Td4
Range Rover L322 - 2002 - 2009 - M57
3.0 diesel & M62 4.4 V8 petrol



DA1189
For removing and installing oil filters on
diesel models of the Freelander 2 and
Range Rover Evoque. 27mm combination
spanner with flexi head. 400mm long.
Manufactured from Chrome Vanadium.
Fully polished with ratchet. Manufactured
to Ansi standards.



DA6119
Crows foot oil filter wrench
Freelander 2
Range Rover Evoque 2.2 diesel
27mm x 1/2" D with switchable bi-hex
ratchet head. Euro 6 compliant engines
from 2010 onwards. Chrome plated
chrome vanadium. Equivalent to OEM
303-1579



DA1173
Oil filter remover for the paper element
from the canister. Prevents damage to the
filter housing.
Discovery 3 - TdV6
Discovery 4 - TdV6
Range Rover Sport - TdV6
Land Rover tool part number - 303-1128

Clutch Tools



DA1147
Clutch alignment tool
Defender - 2007 onwards
Discovery 3 - TdV6 manual
Replace two tools for one with this cost
effective clutch tool. One end is the Land
Rover 308-419 clutch alignment tool
which is used to align the clutch disc and
pressure plate on installation. The other
end of the tool is Land Rover 303-1096
aligner/installer tool which is used to align
the clutch drive plate and install the spigot
bearing.



DA6113
Clutch alignment tool
Defender - 2.4 TD4 - 2007 onwards
Specifically designed to hold the clutch
centre plate centred on the flywheel while
fitting the clutch cover plate. Ensures fast
effective alignment of the clutch centre
plate. 200mm long x 14mm dia with knurled
grip. Equivalent to OEM 308-419.



Brake Tools

DA1153



DA1153
Brake calliper rebuild tool kit
Anyone who has ever tried to rebuild a set of Land-Rover brake callipers will know that the most difficult part is fitting the dust seal after the pistons have been fitted. This extremely awkward task can now be made much easier with the seal fitting tools in this kit. The kit is supplied with a tool to fit 41mm and 44mm pistons and comes complete with a heavy-duty piston spreader to allow the seals to be pushed into place evenly.

DA7460
Heavy-duty piston spreader only.



204-591-02 NEW
Dynamic response control box. For use with 204-591-02. For professional use only.



204-591-01
Dynamic response system bleed bottle. For use with 204-591-02. For professional use only.



DA6136
Adjustable 3 pin EPB brake adaptor with standard 2 pin drive which is adjustable to fit many modern vehicles. Kit also contains a pneumatic brake calliper rewind tool - 3/8" D. This tool is for left and right hand threaded pistons. Suitable for most 3/8" D wind-back adaptors and pin type adaptors. A great time saver in the workshop.



facebook.com/britpart

Crankshaft Tools



DA1160
Engine front casing alignment tool
Defender - 2007 onwards
Land Rover tool part number - 303-682



DA1161
Crankshaft front seal remover/installer tool
Defender - 2007 onwards
Older type seals - LR029318 & LR045106
Land Rover tool part number - 303-679



JLR-303-1619
Crankshaft front seal remover/installer tool
Defender - 2007 onwards
Newer type seals - LR077704



DA6114
Crankshaft rear oil seal removal and installation tool
Range Rover Sport - 2005 - 2009
Range Rover L322 - 2002 - 2013
Freelander 2 - 2006 - 2010
Discovery 3 - 2004 - 2009
Defender - 2007 onwards
Complete with punch to assist seal removal. Equivalent to OEM 303-538



DA6133 NEW
Crankshaft pulley holding tool. Provides the required components to hold the crankshaft vibration damper in place whilst undoing the very tight pulley mounting bolt. Equivalent to OEM 303-191, 303-192, 303-193, 303-194. Designed to be used with a 1/2" D Power Bar. For use on AJ V8 3.2, 4.0, 4.2 & 4.4 petrol engines.



Photo courtesy of Angus Sinclair

Other Workshop Tools



Prop Shaft Fastener Tools
> Size - 3/8" 6 point (hexagon)
> Total length - 150mm
> Outside diameter - 20mm
Specialist socket for prop shaft fasteners on most Land Rovers. The 3/8" socket end is a perfect hexagon with rounded tip profiles to ensure the whole turning power is transferred onto the flanks of the nuts instead of on the corners. The socket's slim wall construction and wine glass profile, coupled to an integral slimline extension means it fits perfectly between the UJ yokes and over the prop shaft nuts without fouling. The 3/8" AF nuts are common to Series Land Rovers, Defenders (90 & 110 up to latest vehicles), Discoverys (up to and including Discovery 2) and Range Rovers (up to and including P38).
DA1065 3/8" square drive
DA1119 1/2" square drive



Photo courtesy of Angus Sinclair



DA1209
For easy removal of the fuel tank metal locking ring (ESR3808) on the Defender - 2002 onwards
Discovery 1
Discovery 2
Freelander 1
Range Rover P38
Range Rover L322



DA6111
Oil pump alignment tool
Defender - 2.2 TD4 diesel - 2006 - 2015
Developed to correctly align the engine oil pump in the sump after an engine rebuild as it is important that the pump be correctly and accurately aligned to ensure the oil pump sprocket is not operating with excessive side loads.

Other Workshop Tools - continued



DA1155
Panel popper tool kit. 12 piece set designed to aid in the easy removal of door trim panels, trim fasteners and mouldings inside or outside the vehicle. Manufactured from a tough & durable engineering plastic to minimise panel damage. Inc. an additional metal clip tool.



DA6126
Diesel injector sockets
A set of six sockets specifically designed for removing diesel injectors. Manufactured from chrome molybdenum for strength and finished in black to prevent corrosion. Contents: 21mm: Ford Duratorq 22mm x 2 lengths; 27mm; 28mm & 28mm with location collar for Defender - Puma 2.4.



DA6134
Diesel fuel system bleeder kit
Freelander 2 - 2.2 diesel
Range Rover Evoque - 2.2 diesel
Hand pressure pump and 4 adaptors. For bleeding/priming the system after fitting new filter or other maintenance on the fuel system. Essential service tool.



DA6132
Cooling system pressure test kit
A comprehensive cooling system pressure testing kit for universal use. 24 pieces including 16 individually sized adaptors, pressure testing pump with gauge, 2 pressure cap test connectors for use with No 3 adaptor and handle. Checks the leakage on original radiator cap. Application list and instructions included. The pressure pump is hand operated and is fitted with an accurate and easy to read gauge marked in both psi and bar. This kit includes a thermometer to aid diagnostics and also ensure the system is cool before removing the cap. Also included in this kit is a very useful radiator pressure cap tester.



DA1235
Defender - Puma
Locking tool to restrain the fuel injector sprocket during a fuel pump removal/installation.



DA1125
Ball joint remover tool kit.
Fit & remove RBG000010 to a Defender drop arm without having to remove the arm from the vehicle.



DA6135
GEN2 Wheel Bearing Kit 82mm
Freelander 2 - 2006 onwards
Front
This kit enables you to be able to remove and replace the bearing/flange in situ.



DA5631
Protect your Defender's wings with a pair of these sturdy, easy to fit wing protectors.



Sign up to the regular Britpart newsletter to find out about all the latest product releases.
www.britpart.com/newsletter

Bush Tools



DA7463
Rear suspension, lower hub bush removal & installer tool
Equivalent to OEM 204-516.
Discovery 3
Discovery 4
Range Rover Sport - 2005 - 2013
Range Rover L322 - 2002 - 2012



DA7466
Rear suspension, upper hub bush removal & installer tool
Equivalent to OEM 204-515.
Range Rover L322 - 2002 - 2012



DA7465
Front suspension, lower arm, front bush removal & installer tool
Equivalent to OEM 204-536.
Designed to remove and refit the front suspension bush of the lower arm with the minimum of dismantling.
Discovery 3
Discovery 4
Range Rover Sport - 2005 - 2013



DA7461
Front suspension, lower arm, rear bush removal & installer tool
Equivalent to OEM 204-535A. For use with RBX500291. Can be used on the vehicle saving time and money.
Discovery 3
Discovery 4
Range Rover Sport - 2005 - 2013

The lower hub bush tool (**DA7463**) and the upper hub bush tool (**DA7466**) have been developed to allow the technician to remove and refit these rear suspension bushes with the minimum of dismantling required. Being able to perform the task on the vehicle saves considerable time over the more traditional use of a workshop press and the requirement that the hub be completely removed. For reference, the **DA7463** bush tool (OEM equivalent 204-516) has been specifically designed to work with OEM bush RBK500220, and the **DA7466** bush tool (OEM equivalent 204-515) has been specifically designed to work with OEM bush RHF000260.



Photo courtesy of LRO Magazine



DA7464
Rear suspension, upper hub bush removal & installer tool
Equivalent to OEM 204-530. Designed for OEM bush RHF500100. Can be used in situ which saves time and reduces the dismantling required.
Discovery 3 / Discovery 4
Range Rover Sport - 2005 - 2013



LRT-60-004
Bush fitting tool
For front radius arm bushes (part number ANR3332) for the Range Rover P38A - impossible to do without using this Land Rover special tool.

Lighting



DA5063

- High Power Mechanics Headlamp
- > 3W Cree LED provides 320 lumens of light output.
 - > Operating times: 2.5hrs (high); 8hrs (med) & 18hrs (low).
 - > Lamp adjusts through 50° to focus on work area.
 - > Tough & robust impact resistant aluminium construction, ideal for a workshop environment.
 - > Weatherproof design for outdoor use.
 - > Adjustable headstrap with padding for comfortable usage.
 - > 4 x AAA batteries included.



DA5026

- Professional LED Inspection Pocket Lamp
- > Rechargeable and cordless for convenient use.
 - > High powered LEDs provides a bright light output.
 - > Anti-slip comfortable grip.
 - > Magnet for hands free use.
 - > LED torch function for focused light output.
 - > Precision reflector provides wide angle light output.
 - > Tough and robust polycarbonate lens for demanding conditions.
 - > Lithium ion battery for faster consistent recharging.
 - > Includes AC mains charging adapter with UK plug.

Specifications

Light output: 120 lumens
 Battery: 3.7v 1200mAh
 Mains adapter: Input 240v - 50/60Hz
 Output 5v - 300mA
 Operating time: 5hrs
 Charging time: 5hrs



DA5027

- Essential LED Inspection Pocket Lamp
- > Magnet for hands free use.
 - > LED torch function for focused light output.
 - > Protective lens for demanding conditions.
 - > Integral swivel pocket clip.
 - > Includes batteries.

Specifications

Battery: 3 x AAA
 Operating time: 5hrs



Add some light to your working environment.



DA5065

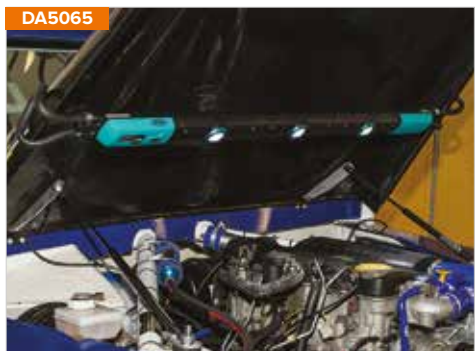

DA5065

- LED Under Bonnet Inspection Lamp
- > 3 x 5W LEDs provide 1,000 lumens light output.
 - > Long operating time allows full working day usage.
 - > 3 levels of light output.
 - > 6000K colour temperature for bright white light.
 - > 40° adjustable head to shine light on the engine bay exactly where it is required.
 - > 60° wide angle illumination.
 - > Sturdy polycarbonate, ABS and aluminium construction.
 - > Rechargeable 3.7V 10,400mAh li-ion battery.
 - > Hook design allows usage with different vehicle types including, cars, vans and 4x4s.
 - > Illuminated battery status indicator.
 - > Includes AC mains adaptor.

Light output: 1000 lumens (3 lamps)
 675 lumens (2 lamps)
 350 lumens (2 lamps)
 Operating time: 6 hours (3 lamps)
 10 hours (2 lamps)
 15 hours (1 lamp)
 Battery: 3.7V Li-ion
 10400mAh
 38.48Wh
 Main adaptor: Input: 230V AC 50/60Hz
 Output: 5V DC 2000mA

DA5065



Photo courtesy of Matthew Reiser



DA5066 / DA5067

MAGflexTwist Ultra Bright LED Inspection Lamp

DA5066 UK plug

DA5067 NEW EU plug

- > Rechargeable and cordless.
- > New technology COB LED provides 250 lumens light output.
- > Lamp can rotate 360° with a 180° ratcheting design to allow ultimate directional lighting.
- > White light output simulates daylight.
- > Wide angle of light output that has uniform intensity.
- > Magnet for hands free use.
- > Integral hanging hook.
- > High power LED torch function.
- > Anti slip comfortable grip.
- > Li-ion battery for faster consistent recharging.
- > Includes AC mains charger and 12v DC charging lead.

Light output: 250 lumens
 Battery: 3.7v Li-ion 2200mAh
 8.14Wh
 Mains adaptor: Input 230v AC-50/60Hz
 Output 5v DC-500mA

Automatic Transmission Flush & Fill Machine



Need a fast, effective, efficient and easy way to change automatic transmission fluid?

DA6800

A standard automatic transmission drain and re-fill will only change about 50% of the contaminated fluid. Wynn's TranServe™ will change about 90% of the contaminated fluid in around 20 minutes. Wynn's TranServe™ is an automatic transmission flush and fill machine which flushes the oil system of automatic gearboxes and which changes the ATF in a simple and effective way.

Properties

- > Cleans the oil system of automatic gearboxes with the Wynn's Automatic Transmission Flush.
- > High exchange rate of up to 90% compared to only 50% with a classic drain and fill.
- > No mixing of old and new fluid.
- > Easy connection to the transmission or transmission oil cooler lines.
- > Operates on the vehicle's battery (12V).
- > Automatically detects the correct flow direction.
- > Different functions:
 - ATF exchange
 - ATF top up
 - ATF drain
 - Adding additive
- > Addition of the product Wynn's Automatic Transmission Treatment:
 - Provides supplementary protection of the gearbox.
 - Smoothens gear changes and improves kick-down response time.
 - Extends life of the transmission fluid by preventing ageing and oxidation.
 - Stops and prevents leaks by revitalising seals and O-rings.

Applications

- > Recommended when changing ATF of automatic gearboxes or when experiencing shifting problems, fluctuating RPM or not retaining the correct gear.
- > For all types of cars with automatic transmission but not to be used on high-pressure systems of buses, trucks, etc.

Automatic Transmission Service Kits

Use the Wynn's TranServe™ in conjunction with the range of automatic service kits from Britpart. For full kit details see the relevant pages in the service kit and transmission sections in the repair and service part of the catalogue.



Technical Data

- > Power source: 12V D.C. (vehicle battery)
- > Dimensions: 650mm W x 1,130mm H x 450mm D
- > Weight: 61 kg
- > Pump:
 - min. flow - 4.5l/min
 - max. flow - 5.5l/min
 - max. pressure - 9 bar
- > Automatic flow detection
- > Reservoir for additives
- > 2 filters
- > Integrated printer
- > Adapter set for all cars



DA6801

Wynn's Automatic Transmission Flush

Size - 325ml x 24 bottles
An oil soluble treatment developed to clean automatic gearboxes and restore their optimal operation.

- > Safely removes varnish deposits.
- > Prepares transmission for new fluid.
- > Cleans all internal transmission components.
- > Smoothens and quietens gear changes.
- > Prolongs component life.
- > Restores optimal gear shifting.
- > Only to be used with TranServe machine.



DA6802

Automatic Transmission Treatment

Size - 325ml x 24 cans
An oil soluble supplement developed to stop and prevent leaks and ease shifting.

- > Stops and prevents leaks.
- > Rejuvenates rubber seals & O-rings.
- > Cleans and protects the system by means of detergents & dispersants.
- > Eases shifting.
- > Prevents ageing and oxidation of automatic transmission fluids.
- > Prolongs component life.
- > 1 can of 325 ml treats up to 6.5 litres automatic transmission fluid.



Enhancements

Make your Land Rover stand out from the crowd. Britpart have a great selection of vehicle enhancements available for all models. The wide range includes both exterior and interior accessories. From steering wheels to vent trim kits, there is something to suit everyone.

Defender	
Electrical.....	217 - 218
Engine bay.....	223
Exterior.....	214 - 216
Interior.....	219 - 222
Screw & bolt kits.....	224
Discovery 3 & Discovery 4	210 - 211
Freelander 1 & Freelander 2	213
Range Rover Evoque	212
Range Rover L322	206 - 207
Range Rover L405	207
Range Rover Sport - Mk1	208 - 209
Range Rover Sport - Mk2	209
Series	224



> Enhancements

Range Rover L322



DA1071 Rear bumper cover
Stainless steel



DA1072 Oval rear badge surround
Metal - chrome finish



DA1073 Lower sill step covers - front & rear
Brushed finish
Pair

Enhance the look of your Range Rover L322



DA5108 Replacement grille
Same as DHB500550LQV but with Brunel outer and chrome inner from VIN 6A



DA5653 Door handle cover - up to 2010
Plastic - chrome finish
Set of 4

DA5654 Door handle surround
Plastic - chrome finish
Set of 4



DA5655 Fog light bezels
2006 - 2009 (from 6A000001)
Plastic - chrome finish
Pair



VUB503660 Air intake grille
Plastic - chrome finish



Shown here fitted to Discovery 3

VUB503880MMM Wing mirror covers - top
5A onwards
(adhesive STC50551)
Plastic - chrome finish
Pair

LR003905 Wing mirror covers - bottom
5A onwards
(adhesive STC50551)
Plastic - chrome finish
Pair



VUB503660 Side step including front mudflaps
EPDM (synthetic rubber) top and hard plastic trimming
Side step replacement insert moulding for VUB503660

VUB001300 Right hand side
VUB001310 Left hand side
Single
Single



VUB002510 Side protection tubes
Black steel
Pair
Tubes can be fitted with or without front mudflaps.



VUB001230 Side protection tubes
Stainless steel
Pair
Tubes can be fitted with or without front mudflaps.

Range Rover L322 - continued



VUB001070LR Front lamp guard
Up to 2006
Black
Not compatible with wraparound protection bar



VUB001080LR Rear lamp guard
Black
Pair



DA2604 Range Rover L322 - excludes amplified
DA2616 NEW Range Rover L322 - amplified

Double DIN radio install fascia, steering wheel control interface and antenna adapter

- > Allows you to upgrade to an aftermarket head unit whilst maintaining use of your factory steering wheel controls.
- > Plug and play, no cutting of wires required.
- > Maintains the original features of the vehicle such as date, time and temperature display.
- > Choose the relevant head unit connection lead according to the make of aftermarket head unit you wish to fit.
- > Contains universal patchlead.



DA4663

Range Rover L322 Vogue - 2002 onwards.
Heated leather steering wheel
Many of early L322 Range Rovers (Vogue shape) still look as good as new with only a few tell tale signs of their age and mileage but steering wheels on some models have lost their leather appearance, gone shiny and started to sag. Range Rover improved the specification of the wheels on later models so they are much more durable. This wheel has the grained leather surface - not the smooth leather as used on the 2010 models. Please note that the spoke covers are not supplied with this steering wheel. You retain your original airbag/switch assembly - this is just the steering wheel frame as shown in the picture.



Range Rover L405



DA4822 Loadspace protector
Semi-rigid foam with anti-slip finish and 2" deep sides



VPLGS0153 Umbrella holders
Excludes umbrella
Pair



VPLGP0100 Side protection tubes
Pair



VPLGP0226 Side steps
Pair



VPLGP0239LR Powered side step - step Left hand
VPLGP0248LR Powered side step - fixings Left hand
VPLGP0238LR Powered side step - step Right hand
VPLGP0249LR Powered side step - fixings Right hand

Range Rover Sport - Mk1



DA1072 Oval rear badge surround
Metal - chrome finish



DA5660 Fog lamp surrounds
Plastic - chrome finish



Air intake grilles
DA3350 Plastic - chrome finish
Left hand side Single
DA3351 Right hand side Single
DA3352 Kit (DA3350 & DA3351) Pair



DA5667 Chrome finish
Air intake grille kit - 2010 Autobiography style
For 2002 - 2009 models



DA5668 Silver finish
Air intake grille kit - 2010 Autobiography style
For 2002 - 2009 models



Air intake grilles
JAK500320WWH Tungsten/Titan finish
Right hand side Single
JAK500330WWH Left hand side Single



LR006304 Air intake grilles
Metal - chrome finish



DA2997 Mesh grille insert - lower
Stainless steel with hand polished mirror finish
Note - 2005 - 2009 models only and not compatible with Adaptive Cruise Control (ACC) System.



DA5658 Door handle cover
Plastic - chrome finish Set of 4
DA5659 Door handle bowl
Plastic - chrome finish Set of 4



Headlight washer jet caps

DA5661 Chrome Pair
DA7602 Zermatt Silver Pair
VPLAB0025LML Primed Pair



Indicator lamps with orange bulb
DA7610 Clear Single
DA7611 Smoked Single



VUB503880MMM Wing mirror covers - top
5A onwards (adhesive STC50551) Pair
Plastic - chrome finish
LR003905 Wing mirror covers - bottom
5A onwards (adhesive STC50551) Pair
Plastic - chrome finish



DA1390 NEW

Range Rover Sport - 2.7 & 3.6
Range Rover Sport - 3.0 - when timed climate is activated
Fuel burning heater is ideal for warming your engine on cold winter mornings while sat in the comfort of your house, no need to go outside and start your engine to defrost the car. The heater is triggered using one of two main options. The first is your Land Rover original blip using its 3rd button, secondly by sending an SMS. As well as a FBH this controller can do a host of other functions including - clear faults, fuel pump prime, diagnostic and statuses on SMS, various run modes, SMS controlled GPS tracking and so much more.

For much more information - www.britpart.com/DA1390



Range Rover Sport - Mk1 - continued



Side sill tread plate kit Stainless steel Set of 8
EBN500040 From AA000001 up to AA218728
VPLSS0042 AA218729 onwards



LR008713 Pedal set
 Stainless steel & rubber Set of 3



VTK500020 Pair
 Side steps with thermo plastic elastomer side step top and brushed aluminium side trim



VUB501930 Front lamp guards
 2005 - 2009 Black Pair



VUB501920 Rear lamp guards
 2005 - 2009 Black Pair



VPLSP0010 Front lamp guards
 2010 - 2013 Black Pair



VPLTP0064 Rear lamp guards
 2010 - 2013 Black Pair



VUB501980 A Bar - moulded plastic Grey
 2005 - 2009 - includes spot lamp brackets

Range Rover Sport - Mk2



VPLGP0226 Side steps Pair
 Powered side steps
VPLGP0239LR Step - left hand side
VPLGP0248LR Fixings - left hand side
VPLGP0238LR Step - right hand side
VPLGP0249LR Fixings - right hand side



DA6290 Range Rover Sport - 2005 - 2011
 Tailgate conversion trim kit with chrome strip
 The rear tailgate on the Range Rover Sport changed in 2012 from a two piece tailgate (with opening top window section) to a one piece tailgate and above the registration plate a new silver strip was added that went the width of the tailgate. If you have a 2005 - 2011 model and want to make it look like the 2012 model from the rear you can fit this clever conversion kit. The kit consists of 3 panels - 1. Underside base - section made from ABS plastic in grey primer finish - you will need to paint this part black. 2. Top section - supplied in primed ABS plastic ready for painting body colour 3. Strip section - chrome plated plastic. This is a bolt on replacement kit that replaces the existing panels on the upper tailgate. The kit can be fitted with the tailgate on the car and you only need a Torx T20 driver socket and a 8mm socket.



DA2611 Range Rover Sport - 2005 - 2013
DA2652 NEW Range Rover Sport - 2005 - 2013 Amplified
 Double DIN radio install fascia, steering wheel control interface and antenna adapter
 > Allows you to upgrade to an aftermarket head unit whilst maintaining use of your factory steering wheel controls.
 > Plug and play, no cutting of wires required.
 > Maintains the original features of the vehicle such as date, time and temperature display.
 > Choose the relevant head unit connection lead according to the make of aftermarket head unit you wish to fit
 > Contains universal patchlead.



Discovery 3 & Discovery 4



DA5662 Discovery 3 Fog lamp surrounds
Plastic - chrome finish Pair



DA5664 Discovery 4 Fog lamp surrounds
Plastic - chrome finish Pair

Enhance the look of your Discovery 3 or Discovery 4



Headlight washer jet caps
DA5661 Chrome Pair
DA7602 Zermatt Silver Pair
VPLAB0025LML Primed Pair



Indicator lamps with orange bulb
DA7610 Clear Single
DA7611 Smoked Single



DA5669 Discovery 3 Side vent trim - Discovery 4 style
Plastic - chrome finish Single



DA5670 Discovery 3 Side vent trim - Discovery 4 style
Plastic - silver finish Single



JAK000065MMM Discovery 3 Side vent trim
Plastic - stainless steel finish Single



VUB503880MMM Discovery 3 Wing mirror covers - top
Plastic - chrome finish Pair
LR003905 Discovery 3 Wing mirror covers - bottom
Plastic - chrome finish Pair
(adhesive STC50551)



DA1390 NEW
Discovery 3 - 2.7
Discovery 4 - 3.0 - when timed climate is activated
Fuel burning heater is ideal for warming your engine on cold winter mornings while sat in the comfort of your house, no need to go outside and start your engine to defrost the car. The heater is triggered using one of two main options. The first is your Land Rover original blip using its 3rd button, secondly by sending an SMS. As well as a FBH this controller can do a host of other functions including - clear faults, fuel pump prime, diagnostic and statuses on SMS, various run modes, SMS controlled GPS tracking and so much more.

For much more information - www.britpart.com/DA1390



facebook.com/britpart



VPLAP0022 Discovery 4 - up to DA999999 A Bar
Black Moulded rubber
Includes spot lamp brackets



VTK500010 Discovery 3/Discovery 4 Pair
VPLAP0035 Side runners with polypropylene side step top and a brushed aluminium side.

Discovery 3 & Discovery 4 - continued



VTD500010 Side protection tubes
Discovery 3/Discovery 4 Black steel Pair



VTD500020 Side protection tubes
Discovery 3/Discovery 4 Stainless steel Pair



VUB501200 Front lamp guards
Discovery 3 Black Pair



VUB501380 Rear lamp guards
Discovery 3 Black Pair



VPLAP0008 Front lamp guards
Discovery 4 Black Pair



VPLAP0009 Rear lamp guards
Discovery 4 Black Pair



LR008713 Pedal set
Discovery 3 Stainless steel & rubber Set of 3



EBN500041 Side sill tread plate kit
Discovery 3/Discovery 4 Stainless steel Set of 4



DA8893 NEW
Blanking plug



Photo courtesy of Mark Harrison



DA2611
Discovery 3
Discovery 4 - will not fit standard audio
Double DIN radio install fascia, steering wheel control interface and antenna adapter

- > Allows you to upgrade to an aftermarket head unit whilst maintaining use of your factory steering wheel controls.
- > Plug and play, no cutting of wires required.
- > Maintains the original features of the vehicle such as date, time and temperature display.
- > Choose the relevant head unit connection lead according to the make of aftermarket head unit you wish to fit.
- > Contains universal patchlead.

Range Rover Evoque



DA8990
Grille Black gloss



DA8991
Side vents Black gloss



VPLVP0071
Side protection tubes Stainless steel Pair



Bonnet grille for 3-door Atlas
LR026593 RHS
LR026596 LHS



Bonnet grille for 3-door Dark Atlas
LR026592 RHS
LR026595 LHS



Bonnet grille for 3-door Black
LR032305 RHS
LR032306 LHS



DA8893 **NEW**
Blanking plug

Enhance the look of your Range Rover Evoque



Photo courtesy of Jundio Salvador

Freelander 2



DA5663 Fog lamp surrounds Pair
Pre-facelift models only Plastic - chrome finish



Shown here fitted to Discovery 3

Indicator lamps with orange bulb
DA7610 Clear Single
DA7611 Smoked Single



Shown here fitted to Discovery 3

VUB503880MMM Wing mirror covers - top (adhesive STC50551)
5A onwards Plastic - chrome finish Pair
LR003905 Wing mirror covers - bottom (adhesive STC50551)
5A onwards Plastic - chrome finish Pair



LR002464 Rear spoiler
Easy to fit - no drilling Primed (as shown)



LR002408 Front lamp guards Pair
Black



LR003685 Rear lamp guards Pair
Black



LR002773 Side step Pair
Thermo plastic elastomer side step top and a brushed aluminium side trim.
LR003318 Side protection tubes Pair
Stainless steel



LR003319 Black bumper styling cover
For vehicles with or without parking sensors.
No spot lamp brackets.



DA8893 NEW Blanking plug

Freelander 1

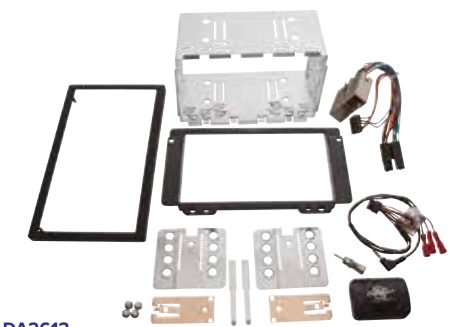

DA2613 Freelander 1 - 2004 - 2006
Double DIN radio install fascia, steering wheel control interface and antenna adapter
> Allows you to upgrade to an aftermarket head unit whilst maintaining use of your factory steering wheel controls.
> Plug and play, no cutting of wires required.
> Maintains the original features of the vehicle such as date, time and temperature display.
> Choose the relevant head unit connection lead according to the make of aftermarket head unit you wish to fit
> Contains universal patchlead.



DA2611 Freelander 2
Double DIN radio install fascia, steering wheel control interface and antenna adapter
> Allows you to upgrade to an aftermarket head unit whilst maintaining use of your factory steering wheel controls.
> Plug and play, no cutting of wires required.
> Maintains the original features of the vehicle such as date, time and temperature display.
> Choose the relevant head unit connection lead according to the make of aftermarket head unit you wish to fit
> Contains universal patchlead.

Enhance the look of your Freelander 2



LR002525 Front and rear sill tread plate kit
Polished stainless steel Set of 4

Defender

Exterior Enhancements



Defender SVX style kit - Defender 2007 onwards
LR008361 Grille and headlight surround kit
Note - Can be fitted to earlier Defenders with some modification.
VPLDV0001 Lights with manual headlamp levelling RHD
VPLDV0003 Lights with manual headlamp levelling LHD



DA1157 Front grille and headlight surround kit
 Brunel grey
Note - Grille badge not included.
 Parts available separately -
DHH100780LQV RHS headlight surround
DHH100790LQV LHS headlight surround
LR038617 Grille
DAG500160 Black/silver logo grille badge
MXC6402 Green/silver grille badge



DA2356 Front grille - stainless steel with natural finish
Note - Will not fit Td5 vehicles with air-con.

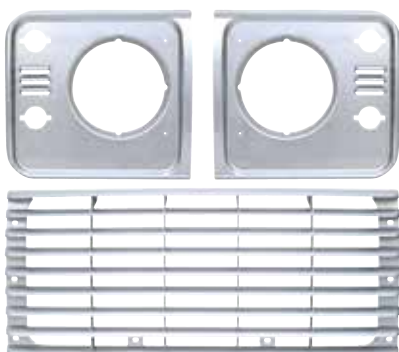

Indus Silver grille & headlamp surround
DA1257 Grille & headlamp surround set
LR059125 Grille
LR059126 Headlamp surround - RH
LR059127 Headlamp surround - LH



Santorini Black grille & headlamp surround
DA1357 Grille & headlamp surround set
LR051771 Grille
LR059128 Headlamp surround - RH
LR059129 Headlamp surround - LH



DA2356B Front grille - stainless steel with black finish
Note - Will not fit Td5 vehicles with air-con.



XS Front grille & headlamp surround
DA1968 Black with silver mesh
 For non-air con Defenders
 Stainless steel screw sets - DA1169 x 2 & DA1138



XS Front grille & headlamp surround
DA1969 Silver with black mesh
 For non-air con Defenders
 Stainless steel screw sets - DA1169 x 2 & DA1138

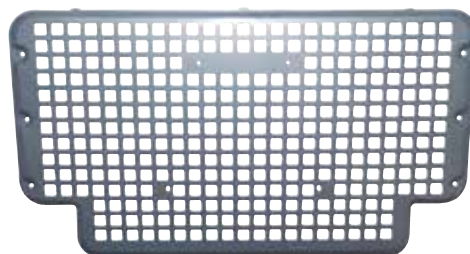

STC60713 Heritage grille for non-air-con Defenders
 Aluminium with silver/grey powder coated finish.



DA8999 Adventure grille Black Plastic



XS Air intake grille Black with silver mesh
DA1970 Right hand side
DA1972 Left hand side
 Stainless steel screw sets - DA3999



XS Air intake grille Silver with black mesh
DA1971 Right hand side
DA1973 Left hand side
 Stainless steel screw sets - DA3999

Enhance the look of your Defender

Defender

Exterior Enhancements - continued



Bonnet vent
Stainless steel
Includes stainless steel screw kit
DA4000SS Left hand side
DA4001SS Right hand side



Bonnet vent
Steel - black
Stainless steel screw kit - DA4000-1FK
DA4000 Left hand side
DA4001 Right hand side



Manufactured from ABS plastic these cowls will help prevent snow, mud and leaves from entering the heater intake and reducing the Defender heater performance. Fitting a cowl will reduce moisture build-up in the intake system which can happen if debris collects in the one-way valve. The cowl fits over the existing grille and follows the profile of the Defender's wing.

DA1270 Left hand drive
DA1271 Right hand drive



XS Bonnet vent
DA1974 Black with silver mesh
Stainless steel screw kit - DA4000-1FK



XS Bonnet vent
DA1975 Silver with black mesh
Stainless steel screw kit - DA4000-1FK



XS Wing mirror
DA6892 NEW Black
Single - excludes arm



XS Wing mirror
DA6893 NEW Silver
Single - excludes arm

DA1963 Puma bonnet White
This Puma GRP bonnet is half the weight of the original Land Rover bonnets and will fit Defender 90 - 1984 onwards/Defender 110 -1983 onwards. The bonnet has return edges on all four sides underneath for strength and to make it more rigid. It has strengthened hinge points and is supplied with stainless steel hinge bolts & screws.



DA6551
Stainless steel lower grille for air con models



XS Door handles
Gloss black
DA6895 NEW Right hand side Equivalent to MXC7652
DA6894 NEW Left hand side Equivalent to MXC7651

Defender

Exterior Enhancements - continued



Britpart have a wide range of replacement door hinges. For more information on these kits, turn to the repair and service section. **DA1131** shown here.



Replace your corroded Defender windscreen brackets with a pair of these smart CNC machined aluminium billet brackets which won't tarnish like the standard brackets. Kits include gaskets and bolts. For fitment to vehicles with hinge type windscreen 2 x reinforcement strap LR016671 are required.

DA1142 Silver anodised finish Pair
DA1142B Black anodised finish Pair



Replace your corroded Defender bonnet hinges with a pair of these smart CNC machined aluminium billet hinges which won't tarnish like the standard brackets. Kits include hinges, hinge bushes and stainless steel bolts.

DA1152 Silver anodised finish Pair
DA1152B Black anodised finish Pair



DA1179 Bulkhead vent hinge pin kit
 Stainless steel 4 hinge pins



DPB104270S Front bumper with silver finish



DPT100070 Rubber bumper end cap Single
Note - Does not include fixings DZM100080



XFC100550CH Number plate light Chrome



DA1187
DA1188 Front - equivalent to MTC3000 & MTC3001 Defender 90 & 110
DA1187 Rear - equivalent to MUC3986 & MUC3987 Defender 90



DA5699 Universal number plate mounting bracket
 405mm wide x 110mm deep Black finish Single
 Number plate not included.



XGB100310L Indicator lamp with orange bulb
 2007 onwards Clear Single

For many more enhancements turn to our extensive range of lights in the lighting section.



facebook.com/britpart



Photo courtesy of Annabel Sammut

Defender



DA4664 Electric window kit
 Defender - 2002 onwards
 Fed up with winding your windows up and down?
 Make life easier, add electric front windows to your
 Defender with this comprehensive kit.
 Includes fitting instructions.



DA5717W
 Waeco version available.
www.britpart.com/DA5717W
 for full details



DA5717 NEW Retrofit insert seat heaters
 > Complete set for driver and passenger seats.
 > Two stages of heating.
 > Kit includes four heating elements and items needed
 for installation.
 > Pre-assembled cable set with switching relay and
 buttons included.
 > Temperature guard to prevent overheating.
 > Heating elements are durable and extremely flexible.
 > For use on seats which have a removable cover.
 > Includes fitting materials and instructions.
 > Test mark: e-approved to 95/54/EC
 (EMC guidelines for vehicles)
 Full details in the Seats & Trim section.

DA6554 LED Interior Lamp Light grey
 Defender - 1991 onwards
 MUD has worked in conjunction with one of the UK's
 leading automotive lighting manufacturers to create a
 100% British designed and manufactured product that
 uses only the highest quality components. The MUD LED
 Interior Lamp utilises ceramic LED technology to provide
 18 x more usable light than the traditional festoon bulb
 design and with a rating of 228 lumens is 400% brighter
 than the factory fitted Land Rover interior lamp. With a
 colour temperature of circa 6,000K, the LED light output
 falls into 'daylight' classification providing better colour
 rendition, i.e. colours look more true to life. Another neat
 feature of the MUD LED Interior lamp is the switchable
 white to red illumination function for improved night-time
 vision. Plug & Play connection with fixings supplied. The
 MUD Interior LED Lamp will replace both front and rear
 interior lamps in the Land Rover Defender. Rear Station
 Wagon fitment requires the use of the optional MUD LED
 Lamp plinth - DA6555. These lamps will fit the Defender
 roof consoles - DA4629 & DA4629B.

Electrical Enhancements



DA4679 Dual USB charger
 Easy to install in existing 12V DC socket hole providing
 convenient access for charging mobile devices.
 > Compatible with popular mobile devices
 > Protective cap
 > Easy to use
 Maximum output current - 2.1A DC (total)
 Cut out dimensions - 1 1/8 in (28.58 mm) dia. hole
 Input voltage - 12V
 Output voltage - 5V DC +/- 5%
 Parasitic current draw - 15mA
 USB - 2.0



DA4598 Heated mirror kit
 MUD-UK Defender heated mirror elements are unlike any
 other heated mirror element. They use the same carbon
 impregnated glasscloth technology found in underfloor
 heating and high-end bathroom mirror applications.
 Unlike traditional printed circuit heated mirror elements
 the current flow in flexible glasscloth is across the whole
 surface area of the element. This results in a larger
 'heated' surface area and avoids the "striping" effect of
 traditional elements. The mirror elements have no fine
 circuits which can damage easily and offer improved
 durability and performance over traditional printed circuit
 elements. The heated mirror elements are supplied with
 self-adhesive backing. Peel off the backing and stick
 the element to the back of the Defender mirror glass.
 Also supplied with a fitting kit that consists of 4m of twin
 core wire, assorted terminals and a relay. A switch is
 not supplied which allows the installer to match up any
 existing switches already installed. The wiring can be
 concealed within the arm of the wing mirror, to create a
 neat and tidy finish. Elements measure 115mm x 167mm.



DA7480 Plug and play cruise control system
 Defender - 2007 onwards
 Stalk fits to the right hand side of the steering column.

DA6555 LED Interior Lamp Plinth Light grey
 Defender - 1991 onwards
 The MUD LED interior lamp plinth allows you to fit the
 popular MUD LED lamp to the rear of a Defender Station
 Wagon. The plinth gives enough room to allow the lamp
 to fit to the existing wiring. Please note the plinth is not
 required when fitting to the front of the vehicle.



DA7481 Voltmeter gauge
 Defender - up to 2006
 Defender - 2007 onwards with additional pod



Photo courtesy of LRO Magazine

Defender

DA2342R



Air conditioning kits

Front Kits

As OE fitment, no drilling required. Once fitted the system is indistinguishable from factory fitted units. Plugs straight into the existing Land Rover wiring loom and fuse board. Easy to install as components are pre-assembled. Kit uses high performance condenser which eliminates need for an extended nose cone. Parts interchangeable with Land Rover parts.

DA2343R	Defender 90/110 - 300Tdi	RHD
DA2343L	Defender 90/110 - 300Tdi NEW	LHD
DA2342R	Defender 90/110 - Td5	RHD
DA2342L	Defender 90/110 - Td5	LHD
DA2344	Defender 90/110 - 2007 onwards	RHD & LHD

Rear Kits

The kit includes a new central box designed to house the unit, plus the necessary hoses and interface manifold that connects to the front system. The central box comes complete and is a drop in replacement including a new floor plate for the vehicle, replacing the original floor plate that is beneath the cubby box or third seat if fitted.

DA6504	Defender 110/130 - 2007 onwards	RHD & LHD
DA6506	Defender 110/130 - 300Tdi & Td5	RHD
DA6505	Defender 110/130 - 300Tdi & Td5	LHD

Note - All rear kits do not fit vehicles with automatic transmission. Kits DA6505 & DA6506 are for vehicles with the under dash air-con system already fitted.

Electrical Enhancements - continued

DA1401

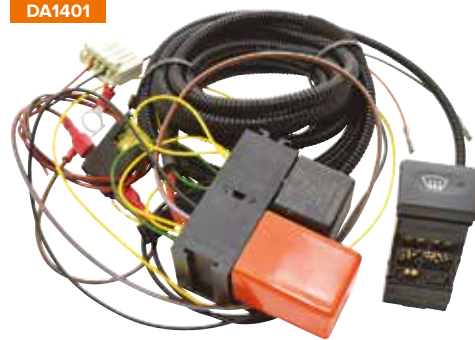

Heated windscreen components

Make scraping your Defender's windscreen on a frosty morning a thing of the past by fitting one of these kits.

DA1400	Carling Contura switch kit
DA1401	Land Rover switch kit
DA1406	Harness fleece tape - 19mm x 25m
CMB000411	Tinted heated windscreen

Five way switch housing connector plugs

DA1402	Black
DA1403	White
DA1404	Blue
DA1405	Green



For more details and technical information on these kits - www.britpart.com/heated



Sign up to the regular Britpart newsletter to find out about all the latest product releases. www.britpart.com/newsletter



Photo courtesy of Jake Perks

Defender

Interior Enhancements



Interior side door handles
DA8935 Black anodised aluminium Single
DA8936 Silver anodised aluminium Single



Grab handles
DA8937 Black anodised aluminium Single
DA8938 Silver anodised aluminium Single



Door lever surrounds
DA8953 Black anodised aluminium Pair
DA8954 Silver anodised aluminium Pair



Vent knobs - up to 2007
DA8947 Black anodised aluminium Single
DA8948 Silver anodised aluminium Single



Heater control knobs - up to 2007
DA8945 Black anodised aluminium Single
DA8946 Silver anodised aluminium Single



Fuse box screws - up to 2007
DA8949 Black anodised aluminium Single
DA8950 Silver anodised aluminium Single
MTC9968S NEW Polished aluminium Single



Locking pegs
DA8943 Black anodised aluminium Single
DA8944 Silver anodised aluminium Single



Gear lever and transfer gear lever set Pair
DA5500 R380 gearbox Anodised alloy
DA6600 LT77 gearbox Anodised alloy
 See trim section for gearbox gaiters.



DA5051 Defender - Puma
 A great replacement for your standard Defender gear lever. These polished aluminium gear levers are easy to fit with no modifications required. Just remove the plastic from the existing levers and swap with these high quality replacements.

Enhance the interior of your Defender



DA2610
 Coin tray for Defender - 1987 - 2006



Glove box kit
 Neat storage solution for the new Defender which utilises the available dashboard space. Ideal for storing all the usual small items you carry with you. Robust construction and easy to fit with all the necessary parts supplied. Suitable for right and left hand drive models.
DA2603 Defender - 2007 onwards
DA2603CF Defender - 2007 onwards Carbon fibre effect finish fascia plate



Defender



AFP710120SS Loadspace mat retainer
Stainless steel strip with stainless steel fixings



DA1205 Defender - up to 2007
Fitting this Defender demister kit will help demist your windscreen better than the standard fitted demister and has the added bonus that it will also demist your side windows too. With full fitting instructions.



DA1170 SVX style cargo tie down point
Smart and easy to fit



DA6493 X-Trouser
Pair
Lost a pair of trousers getting in and out of your Defender? Here is the simple solution. Not only does it protect your trousers, in many cases it makes the door close more reliably and helps (though it does not entirely stop) the seat belt getting caught in the latch. If the seat belt does become caught as you close the door, it suffers less damage due to the smooth profile of the X-Trouser. The X-Trouser has a smooth profile, if your belt loop or pocket runs over it, it will slide off freely. Made from high quality 304 grade stainless steel. The X-Trouser catch is reversible so it will fit both the driver and passenger doors, left & right hand drive. It will also fit the rear side doors of 110 Station Wagons.

Interior Enhancements - continued



DA1204



DA1203

DA1204 Rear door stays
Does your Defender's rear door sometimes close on you unexpectedly? This neat and easily installed gas strut kit will solve that problem and replaces the original door stopper. The gas strut will hold the door in place when open - even with a spare wheel in place - and will assist in the opening of the rear door too with a smoother and more controlled movement. Complete with fittings and instructions.

DA1204 Defender - up to 2002
DA1203 Defender - 2002 onwards



DA4692 NEW 110 Utility Wagon trim panels
Protect the interior of your 110 Utility Wagon and improve upon the crude 'unfinished' factory look of the Land Rover 'window' trims with our MUD designed 110 Utility Wagon Trim Panels. The MUD 110 Utility Wagon Trim Panel fits behind the existing 'window' trim panel to create a smart factory look finish. The MUD 110 Utility Wagon Trim Panels are supplied in pairs with cargo nets that create useful extra storage within the cabin walls. Ideal for coats, shopping bags and pet paraphernalia! Each net features elasticised netting and is supplied with black headed flush fit fasteners for a professional appearance. With a typically MUD level of attention to detail, they've had the plastic of the MUD 110 Utility Wagon Trim Panel specially blended to match the correct 'Dark Granite' shade of the original trim panels to provide an OE appearance to the installation. Each MUD 110 Utility Wagon Trim Panel is supplied with four foam insulation panel that sit behind the trim panels to isolate vibrations and provides an additional layer of insulation.



MTC2640A NEW Defender - up to 1A999999
Black aluminium switch mounting panel
Excludes switches



DA4629

Roof consoles
DA4629 Grey
DA4629B Black

This roof console fits all Defenders except sunroof equipped models. Supplied with interior lamp extension loom and DIN blanking panel. Fitting kit and instructions are also supplied.

The console offers a unique storage solution for the Defender in providing additional overhead roof storage as well as a single DIN provision in one unit. The two side sections are designed to hold anything from maps to sunglasses, documents to magazines.



DA4629B

The console is supplied in three separate pieces. The product has been designed with CAD software and the moulding finished off using CNC machinery to ensure an OE level fit and finish to the product.

It is supplied with a DIN blanking panel but the central binnacle will fit any DIN sized accessory such as a stereo, CB/HAM radio or even a digital tachograph. The single DIN aperture will also accept a bank of seven Carling Technologies switches by using the Carling interlocking switch mounts.

Will the Defender roof console fit my vehicle?

The console has been designed to fit all post 1983 Defender models without a sunroof and with a factory headlining. The fixing method does not require removal or cutting of the headlining or sun visors. (Some later models will require trimming of the central area of the headlining when fitting a DIN unit). If you have a non-factory headlining it is unlikely it will fit without modification of the headlining. If you have a Series vehicle, again it is unlikely it will fit without modification.



DA4691 NEW Single DIN dashboard mount
Defender - 2007 onwards
The MUD dashboard mount creates a quick and easy method of mounting a single DIN accessory into the Puma dashboard. You will however have to route any wiring through the back of the dashboard. Ideal for mounting any DIN sized CB/HAM radio unit into your Defender. Mic extension leads are an inexpensive accessory and commonly available so that mic can reach the driver. The single DIN mount also comes with a handy 'coin tray' which sits behind the grab handle. The dashboard mount is also suitable as a digital tachograph mount. EU customers should be aware that mounting a tachograph on the passenger side of the dashboard does now meet EEC legislation. Supplied with all fixings required to provide a quick and easy installation. Fits both right-hand drive and left-hand drive vehicles.

Defender

Interior Enhancements - continued

DA8958

Replace your old or lost 12V cigar lighter blanking plug with this smart chrome topped one.



Add a splash of colour to your Defender's interior by fitting a set of these red seat belts. Type approved.

- DA5055** Defender - truck cab RHS
Equivalent to BTR6562
- DA5056** Defender - truck cab LHS
Equivalent to BTR6561
- DA5057** Defender - station wagon Front
Equivalent to BTR6563
- DA5079 NEW** Defender - station wagon - Td5 onwards Front
RHS
- DA5080 NEW** Defender - station wagon - Td5 onwards Front
LHS
- DA5058** Defender - station wagon Rear
Equivalent to EVL501580
- NEW DA5059RH** Defender 110 - 2007 onwards Crew cab pick up - non-hi-cap Rear outer - right hand side
Equivalent to EVL501600PMAG
- NEW DA5059LH** Defender 110 - 2007 onwards Crew cab pick up - non-hi-cap Rear outer - left hand side
Equivalent to EVL501610PMAG
- NEW DA5060RH** Defender 110 - From YA183533 - 2007 Crew cab pick up - non-hi-cap Rear outer - right hand side
Equivalent to EVL00080PMAG
- NEW DA5060LH** Defender 110 - From YA183533 - 2007 Crew cab pick up - non-hi-cap Rear outer - left hand side
Equivalent to EVL00090PMAG

DA2608



Defender - 2007 onwards
Double din fascia plate
This fascia kit allows the installation of a double DIN head unit into a non-double DIN size aperture. High quality finish designed to match the vehicle dashboard. Complete fascia kit, supplied with brackets to mount the aftermarket double DIN head unit.

- DA2608** Piano black
- DA2609** Matte black

DA5079



DA1266

Clutch pedal assist kit
Replace the old clutch pedal spring kit to assist the pressing of the clutch pedal on Defender models. This is a factory fit on later models but can be retro fitted to all 90/110 models. Consists of spring, spring retainer & spring bushes.

DA5055

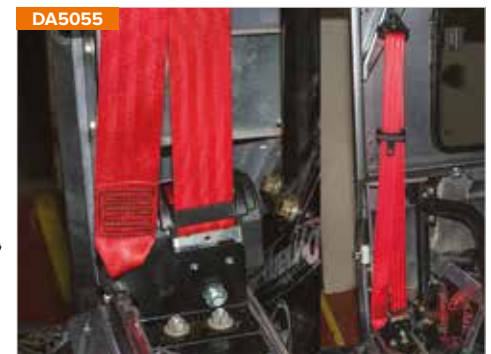

DA5726



DA5727



DA5728



DA5729



DA5730



DA5734



Momo Steering Wheels

DA5726	Quark style	Black/air leather	350mm
DA5727	Jet style	Black leather	350mm
DA5728	Millennium Sport style	Black/grey profile	350mm
DA5729	Nero style	Black/suede	350mm
DA5730	Tuner style	Black leather	350mm
DA5734	36 spline boss		
DA5735	48 spline boss	Defender - up to FA	
DA5736	48 spline boss	Defender - FA onwards	

Mountney Steering Wheels

DA4650	3-spoke sports wheels	Black vinyl/black centre	380mm
DA4654	3-spoke sports wheels	Black vinyl/black centre	355mm
DA4661	16mm shaft/36 splines		
90/110 & Defender up to HA & 1A onwards This is drilled and has a contact plate. Pins are spaced at 38mm across, flat centre.			
DA4659	16mm shaft/36 splines		
90/110 & Defender up to HA & 1A onwards This is not drilled, pins are spaced at 28mm across, centre of splines casting is raised by 5mm			
DA4660	19mm shaft/48 splines		
Defender - JA onwards & Series 2 / 2A / 3			

DA4650



DA4654



Shown with bosses fitted.



facebook.com/britpart

Defender

Interior Enhancements - continued



DA8091	Defender - 1983 - 1998	Bonnet
DA8093	Defender - Td5	Bonnet
DA8092	Defender - 2007 onwards	Bonnet
DA8094	Defender - 1983 - 2006	Foot wells
DA8083	Defender - 2007 onwards	Foot wells
DA8095	Defender - 1983 - 2006	Seat box
DA8084	Defender - 2007 onwards	Seat box
DA8085	Defender - 2007 onwards	Rear tub behind front seats
DA8086	Defender - 90 - 1983 - 2006	Rear tub floor
	Defender - 90 - 2007 onwards	
	Defender - 90 - 1983 - 2006	
DA8087	Defender - 90 - 2007 onwards - commercial only	Rear wheel arches
	Defender - 110 - 1983 - 2006 - Station Wagon	
DA8096	Defender - 90 - 2007 onwards - County	Rear arches
DA8088	Defender - 110 - 2007 onwards - Station Wagon/Utility	Rear arches
DA8097	Defender - 90 - 2007 onwards - County	Rear floor
DA8089	Defender - 110 - 2007 onwards - Station Wagon/Utility	Rear floor
DA8090	Defender - 110 - 2007 onwards - Station Wagon/Utility	Second row floor/under seats
DA8076	Dynamat Xtreme sheet	1,200 x 610mm

All kit images available at
www.britpart.com/dynamat



Dynamat Xtreme Sound Deadening

Dynamat Xtreme is the highest efficiency sound deadening material available and the most effective product for stopping noise and vibration. Xtreme can be used on any and all interior sheet metal and fibreglass body panels. The aluminium constraining layer is very moldable and conforms easily to all interior surfaces. The patented extra sticky butyl layer is formulated with VECTOR chemistry for the most amazing energy conversion capabilities ever. Use it on your doors, floor, roof, bonnet and loadspace for a quiet, cool and incredibly solid ride.

- > Create a solid, luxury car feel with a reduction in road noise.
- > Stop resonance & vibrations, reduces buzzes & rattles.
- > Improved sound. Get more bass. Hear more of your music.
- > For use throughout your vehicle interior, the first step to a great car.



The highest efficiency sound deadening material available.



Photo courtesy of Dr Klaus Wolf

Defender

Engine Bay Enhancements

ERR4686BLUE



Filler Plugs

ERR4686BLUE Blue

ERR4686RED Red

Replace your existing filler plug with one of these smart anodised aluminium ones. Suitable for use on a Defender, Discovery 1 & Range Rover Classic on the radiator and thermostat housing. Can also be used on the diff filler level on a Discovery 2.

ERR4686RED



DA8896



Expansion Bottle Cap

DA8896

Defender - Td5 onwards
Freelander 1

Smart anodised aluminium direct replacement expansion bottle cap - PCD100160. Will not fit on aluminium header tank - DA4751.



DA8891



Oil Filler Cap

DA8891 NEW

Defender Tdci
Anodised aluminium.
Includes rubber seal



DA8890



Oil Filler Cap

DA8890 NEW

Defender - Td5

Anodised aluminium. Includes rubber seal

DA8894



Power Steering Reservoir Cap

Defender

Anodised aluminium. Includes rubber seal.

DA8895 NEW

Standard

DA8894 NEW

With cooling fins for extreme off-road and racing conditions



DA8894



DA8895

PYP10008RED



Bleed Screws

Smart replacement anodised aluminium bleed screws for the top hose on a Td5 engine.

PYP10008BLUE Blue

PYP10008RED Red



PYP10008BLUE



Photo courtesy of Simon Ellingworth

Defender

Screw & Bolt Kits

Stainless Steel Bolt & Screw Kits

Using these smart stainless steel replacement bolt and screw kits will prevent rust from spoiling your Defender's bodywork - ideal for smartening up your vehicle or a restoration job. For more information on the kits contents please look online at www.britpart.com/bolts



DA1133 Front & rear door - 4-door - bolt kit
Defender
DA1133P Defender - 2007 onwards



DA1132 Front door - 2-door - bolt kit
Defender
DA1132P Defender - 2007 onwards



DA1260 2nd row door - bolt kit
Defender
DA1260P Defender - 2007 onwards



DA1145 Rear door - hinge pin kit
Defender/Series



DA1134 Rear door - Safari - bolt kit
Defender
DA1134P Defender - 2007 onwards



DA1135 Bonnet hinge - bolt kit
Defender



DA1139 Bumper - bolt kit
Defender



DA1136 Rear cross member to body - bolt kit
Defender



DA1137 Light lens - screw kit - sidelights, indicators and rear lights
Defender - up to MA94004
DA1168 Defender - MA94005 onwards



DA1169 Headlight panel - screw kit
Defender



DA1138 Front grille kit - screw kit
Defender



DA1977 NEW Air intake grille- screw kit
Defender



DA4000-1FK NEW Bonnet vent - screw kit
Defender



Photo courtesy of Alan Twigg

Series



XFC100550CH Number plate light



DA6110 Chrome headlamp surround
Series 1, Series 2 & Series 2A



Photo courtesy of Chris Lawther

Miscellaneous

This section contains a variety of products, including Britpart and Land Rover merchandise, workshop books and many other great gift ideas for any Land Rover enthusiast!

Books, Manuals & Technical Publications

Catalogues, manuals & more.....	226
Haynes books & manuals.....	226
Land Rover Original technical publications.....	228
Landy books.....	227
Mag books.....	227
Range Rover - The First Fifty.....	227

Camping Equipment

Camping chair.....	232
Cool bag.....	231
Fridge freezers.....	231
Fridge freezer remote monitor.....	231
Tent, shade & shelter.....	232

Gifts & Merchandise

Britpart clothing.....	233
Britpart distributor merchandise.....	238
Britpart merchandise.....	234
Die-cast models.....	237
Haynes internal combustion engines.....	238
Land Rover merchandise.....	235 - 236
T-Shirts.....	233

Heavy-Duty Wiper Blades..... 238

Radiator Muffs..... 230

Security Equipment

Hinge guards.....	230
Locking fuel cap.....	229
Security marking kit.....	229
Skytag.....	229
Tamper proof nuts & bolts.....	229
X-Column.....	229
X-Defend pedal lock.....	230

Starting Handle..... 238

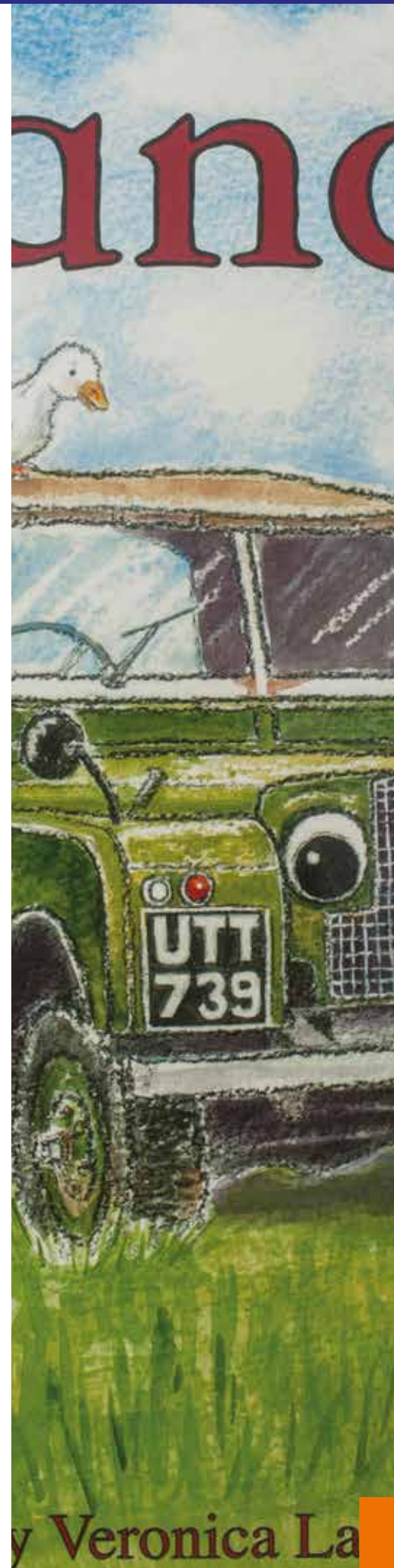

Books, Manuals & Technical Publications

Haynes Books & Manuals

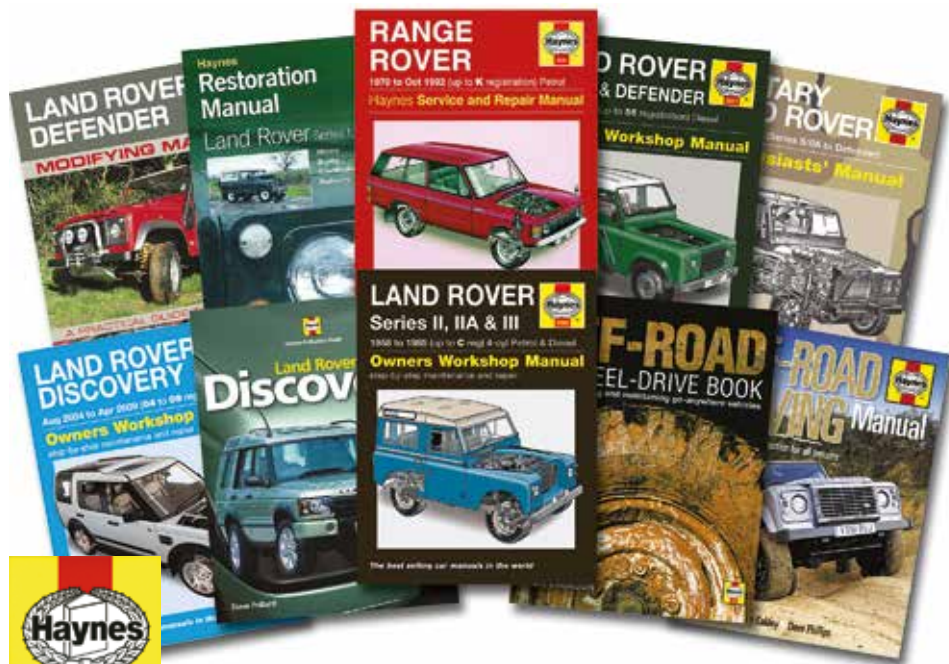

The worldwide market leader in automotive repair manuals

Defender		
DA3035	Owners Workshop Manual	90, 110 & Defender - 1983 - 2007 (up to 56 reg) - Diesel
DA3189	Modifying Manual	A practical guide to upgrades - By Lindsay Porter
DA3040	Restoration Manual	90, 110 & Defender - By Lindsay Porter REDUCED TO CLEAR
DA4558	Restoration Manual	90, 110 & Defender - By Lindsay Porter
Discovery		
DA3036	Haynes Service & Repair Manual	Discovery - 1989 - 1998 (G to S reg) - Petrol & Diesel
DA3106	Enthusiast Guide	Discovery - By Dave Pollard
DA4493	Owners Workshop Manual	Discovery - Nov 1998 - July 2004 (S to 04 reg) - Diesel
DA4505	Owners Workshop Manual	Discovery - Aug 2004 - April 2009 (04 to 09 reg) - Diesel
Freelander		
DA4565	Owners Workshop Manual	Freelander - 1997 - Oct 2006 (R to 56 reg) - Petrol & Diesel
	Note - Does not cover models with 2.5 V6 petrol engine	
DA4588	Owners Workshop Manual	Freelander - Nov 2006 to 2014 (56 to 64 reg) - Diesel
Range Rover		
DA3048	Haynes Service & Repair Manual	Range Rover Classic - 1970 - Oct 1992 (up to K reg) - Petrol
Series		
DA4636	Owners Workshop Manual	Series 2, 2A & 3 - 1958 - 1985 (up to C reg) Petrol & Diesel
DA3041	Restoration Manual	Series 1, 2 & 3 - By Lindsay Porter
General Interest		
DA3044	The Off-Road 4-Wheel Drive Book - Choosing, using and maintaining go anywhere vehicles By Jack Jackson	
	Off-Road Driving Manual By Vince Cobley & Dave Phillips.	
DA4566	Step-by-step instruction for all terrains. This extensively illustrated step-by-step manual is aimed at all drivers wishing to learn to drive safely and successfully off-road, whether for the occasional trip across a field or to prepare for an off-road expedition in a remote part of the world.	
	Military Land Rovers By Pat Ware	
NEW DA4555	An insight into the history, development, production and roles of the British Army's light four-wheel drive Land Rover. Land Rovers have been used by the military since they were introduced.	



Photo courtesy of Sirsendu Gayen

Catalogues, Manuals & More...

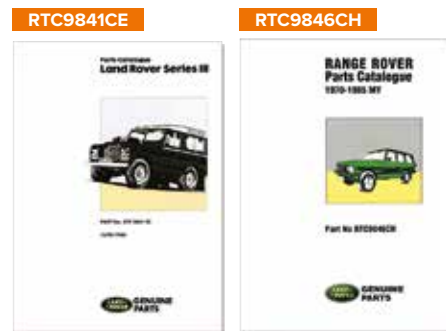

Parts Catalogues	
RTC9840CC	Series 2A - Bonneted Control
RTC9842CE	2A, 3 & 109 V8 - Optional Equipment
RTC9841CE	Series 3
RTC9863CE	One Ten
	Covering vehicles up to August 1986
STC9021CC	Defender 90/110/130
	Covering 1987 - 2006
	Discovery 1
RTC9947CF	Covering 1989 - 1998 - 2.0 Mpi/3.5/3.9 V8 petrol & 200Tdi/300Tdi diesel engines
RTC9846CH	Range Rover Classic - 1970 - 1985
STC9049CA	Discovery 2 - Covering 1999 - 2003
	Range Rover P38
RTC9970CE	Covering 1995 - 2001 - 4.0/4.6 petrol & BMW 2.5 diesel engines

Handbooks	
	Defender 90/110/130
DA3162	Covering 1991 - February 1994 - 2.5/3.5 V8 petrol & 2.5/200Tdi diesel engines
	Defender 90/110/130
LRL0087ENG	Covering March 1994 - 1998 - 2.5/3.5 V8 petrol & 2.5/300Tdi diesel engines
DA3161	Discovery 2 - Covering 1999 - 2004

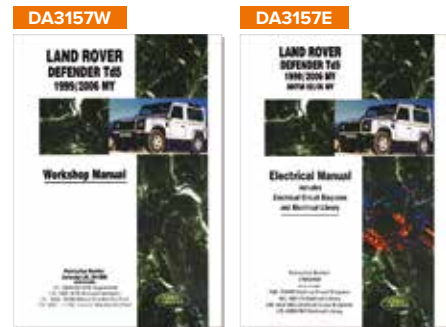

Workshop Manuals	
DA3157W	Defender Td5 workshop manual
DA3157E	Defender Td5 electrical manual
DA3147	Freelander 1 - 2001 - 2003 onwards Includes V6 petrol engines
DA3148	Range Rover L322 - 2002 - 2005* Workshop manual
	Range Rover L322 - 2002 - 2005* Electrical manual
DA3149	Includes electrical library and electrical circuit diagrams

*Covering BMW 4.4ltr petrol V8 engines & BMW 3.0L diesel engines

Other Publications	
DA3156	Winch In Safety - A5 hand book by Land Rover with pictures throughout.
LRL0178ENG	Replacement service portfolio



Landy Books

These charming hardback books, which are beautifully written and illustrated by Veronica Lamond, are an excellent gift idea for any Land Rover fan - whatever their age!

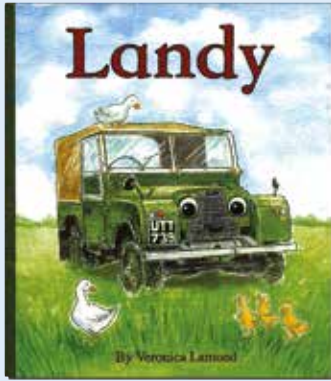

LANDY
"Landy has been left abandoned for many years until, one day, Jack finds him..."

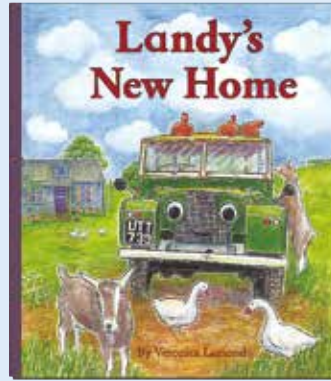

LANDY NEW HOME
"Jack and Landy are busy setting up their small holding but Landy feels left out. When Fender arrives, Landy realises he hasn't been forgotten after all..."

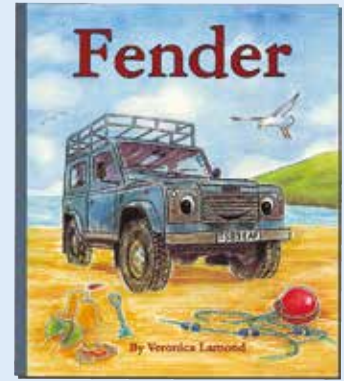

FENDER
"Scamp races Fender down the track - they have lots of things to do and lots of friends to meet..."

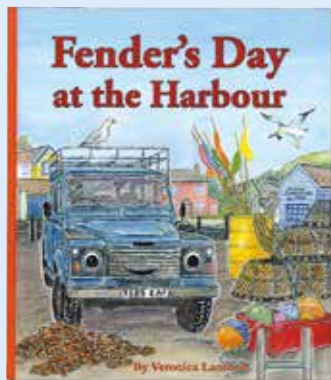

FENDER HARBOUR
"Fender watched the fishermen fixing their boats and the swing shovel at work. Meanwhile, Dan and Jack weren't having much luck..."

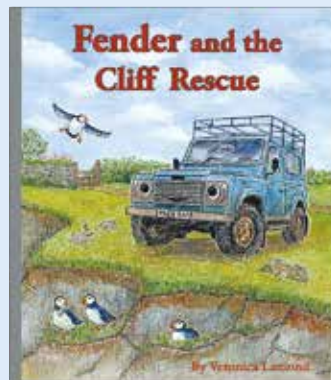

FENDER RESCUE
"Dan and Fender spend a day working up on the cliff top. Then Jack calls for help and they drive off to the rescue..."

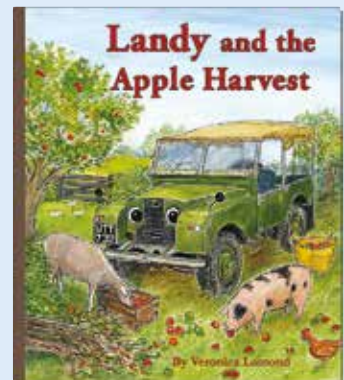

LANDY HARVEST
"After a very windy night, Jack decides it's time to gather up all the fallen apples. Landy helps him bring the harvest home..."



Sign up to the regular Britpart newsletter to find out about all the latest product releases.
www.britpart.com/newsletter

Mag Books



DA3188B Issue 2
From the publishers of Land Rover Monthly a 228 page celebration of the Defender including vehicles through the ages, rebuilds & repairs and buyers guides.



DA2988
From the publishers of Land Rover Monthly a 220 page celebration of the Discovery. Buying, restoring, modifying, driving - the ultimate Land Rover Discovery guide.

Range Rover - The First Fifty

DA3202
Range Rover - The First Fifty Prototypes
YVBs and NXCc - the story of the early Range Rovers.

Today, the Range Rover is a legend. The original design lasted in production for more than a quarter of a century. It is those very first Range Rovers which are the subject of this book. Its aim is to record the story of the earliest vehicles before it becomes lost in the mists of legend and distorted by commercial misrepresentation. It looks at three distinct groups of vehicles. These are the Engineering Prototypes (of which there were seven), the Pre-Production Vehicles (of which there were 28, most registered in the YVB-H series), and the Press Launch Vehicles (of which there were 20, all registered in the NXC-H series). The total comes to slightly more than 50 vehicles. With 160 illustrations and 160 pages.

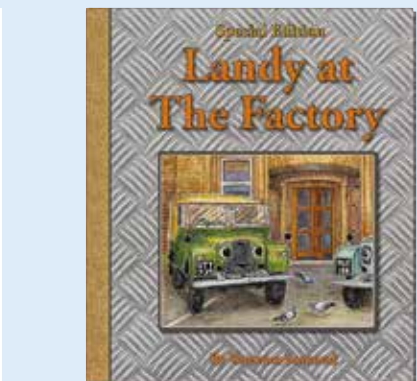
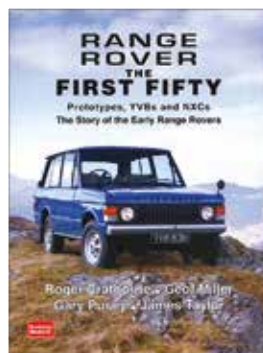

LANDY FACTORY
"Inside the envelope, he found a letter from the Land Rover factory. "How exciting, Landy," said Jack. "We've been invited to visit the factory to celebrate your 60th birthday!..."

Join me and my friends on our adventures.



Land Rover Original Technical Publications

Original Technical Publications

The days of hunting around auto-jumbles for grubby and damaged workshop manuals, parts lists and owner manuals are over! At least they are if you own one of the many classic Land Rover and Range Rover models covered in the range of Original Technical Publications compilations.



Land Rover Original Technical Publications

Carefully reproduced from the extensive historical archives in England and in the USA, we are pleased to give you access to the original Land Rover publications needed to run and maintain your classic Land Rover, including parts catalogues (most models), service manuals and owner's literature. Original parts books, workshop manuals and handbooks for Land Rovers and Range Rovers have always been greatly sought after, and rightly so: nothing compares to a Land Rover workshop manual compiled by the car's manufacturer. Now owners and enthusiasts have the opportunity to effortlessly collect all the original publications for their favourite Land Rover or Range Rover, on one handy and cost-effective title. These publications are the original publications used by the Land Rover parts department, service garages and sales departments when these cars were still in production and being serviced. Each section provides detailed information on major systems, diagnostics, troubleshooting, overhaul, as well as the removal and installation of major components. Compiled in an easy to understand format, these publications contain step by step processes designed for the mechanic and the enthusiast. In addition most manuals are filled with detailed illustrations and sometimes photographs and diagrams to help with identification of components and proper assembly. What's more, you can find information and links to Land Rover Cars, Land Rover Heritage, Land Rover Clubs and Original Technical Publications. Check out the latest picture galleries, video and media archives - even download classic Land Rover and Range Rover wallpaper to personalize your computer, tablet or phone.

Which is best for me?

The Original Technical Publications are available in two formats - USB eBook or DVD with online access.

Windows PC user - Portable USB eBook or DVD with online access

Apple OSX user - DVD with online access*

Note - DVD option for OSX not suitable for retina displays, for retina displays use Online feature.

Apple iOS user - DVD via the online access

Android user - DVD via the online access

Note - Printing not available for Apple OSX or iOS applications unless running a Windows emulation software.



DVD With Online Access Product

In addition to the DVD, each OTP Product now includes an 'online access card inside the packaging. The card includes some additional text and instructions as well as the URL or web address required to access the interface and content from a personal computer (Mac OSX or Windows) as well as tablets or hand-held devices (Mac iOS, Windows or Android). Each OTP product continues to provide each registered customer with a single license for one device. In other words if a customer registers their personal computer they would be able to access BOTH the DVD as well as access the information online on that device. If a customer registers their hand-held device (iPad, tablet or hybrid) they would ONLY have access on that device once the viewer is installed and the license is authenticated.

Product Features

- > Printable - print only the pages you need
- > Viewable & zoomable
- > Searchable - search the entire section in seconds
- > Bookmarked - manuals are bookmarked to quickly locate sections

System Requirements

- > User must have administration rights to allow installation.
- > PC Windows 2000 or later DVD Drive, Safeguard Windows PDC viewer
- > Mac OS X 10.7 or above DVD Drive, Safeguard OS X PDC viewer*
- > iOS 5.0.1 and above Safeguard Mac iOS viewer
- > Android 4.0 and above Safeguard Android viewer

DVD option for Apple OSX not suitable for retina displays, for retina displays use online feature. Printing not available for Apple OSX or iOS applications unless running a Windows emulation software.

Portable USB Product

USB for Windows PCs. Installation of viewer on host computer is all that is required as the user license is bound to the USB. Internet access is not required for use or activation unless the user is prompted to check for a viewer update for the particular device where the USB is being used. Each (Portable USB ebook) product is a portable software product, no registration or activation is required. DRM license is bound to the supplied USB enabling product access only to that particular Portable USB. USB product part numbers will be the same as the USB DVD/Online designations however, with the suffix USB added to the end, no product registration codes are required.

Product Features

- > Printable - print only the pages you need.
- > Viewable & zoomable
- > Searchable - search the entire section in seconds.
- > Bookmarked - manuals are bookmarked to quickly locate sections.
- > Internet not required.
- > Portable between Windows computers.
- > Secure documents are instantly accessible just like ordinary files.

System Requirements

- > PC - Windows 2000 or later. DVD Reader, Safeguard Windows PDC viewer. Must have administration rights to allow installation.
- > USB port

Both products are Handy & Easy to use!

LTP3001	Series models - 1948 - 1985. Includes military Land Rover 90, 110 & 127
LTP3003	Defender 90, 110 & 130 - 1983 - 2011. Includes military
LTP3004	Discovery 1 - 1989 - 1999
LTP3006	Discovery 2 - 1999 - 2004
LTP3016	Discovery 3 - 2004 - 2008
LTP3017	Discovery 4 - 2009 - 2012
LTP3007	Freelander 1 & Freelander 2 - 1998 - 2011
LTP3002	Range Rover Classic - 1970 - 1995
LTP3005	Range Rover P38 - 1994 - 2001
LTP3008	Range Rover L322 - 2002 - 2010
LTP3015	Range Rover Sport - 2005 - 2009

LTP3001USB	Series models - 1948 - 1985. Includes military Land Rover 90, 110 & 127
LTP3003USB	Defender 90, 110 & 130 - 1983 - 2011. Includes military
LTP3004USB	Discovery 1 - 1989 - 1999
LTP3006USB	Discovery 2 - 1999 - 2004
LTP3016USB	Discovery 3 - 2004 - 2008
LTP3017USB	Discovery 4 - 2009 - 2012
LTP3007USB	Freelander 1 & Freelander 2 - 1998 - 2011
LTP3002USB	Range Rover Classic - 1970 - 1995
LTP3005USB	Range Rover P38 - 1994 - 2001
LTP3008USB	Range Rover L322 - 2002 - 2010
LTP3015USB	Range Rover Sport - 2005 - 2009

See www.britpart.com/otp for much more in depth information about what is included with each product. Far too much to list here!



Online Access Option/Feature

In addition to the DVD, each OTP Product now includes an "online access" card inside the packaging. The card includes some additional text and instructions as well as the URL or web address required to access the interface and content from a personal computer (Mac OSX or Windows) as well as tablets or handheld devices (Mac iOS, Windows or Android).

Each OTP product continues to provide each registered customer with a single license for one device. In other words if a customer registers their personal computer they would be able to access BOTH the DVD as well as access the information online on that device. If a customer registers their handheld device (iPad, tablet or hybrid) they would ONLY have access on that device once the viewer is installed and the license is authenticated.

NEW Sign up to the regular Britpart newsletter to find out about all the latest product releases.
www.britpart.com/newsletter

LTP3010 NEW Models Covered

See web for full details
LTP3001, LTP3002, LTP3003, LTP3004, LTP3005, LTP3006, LTP3007, LTP3008, LTP3015, LTP3016 & LTP3017

Security Equipment

Skytag

DA9012

How It Works

- > Pinpoint GPS tracking
- > Worldwide coverage
- > 24/7 service
- > Tamper alerts
- > Intelligent movement alerts
- > Direct police access and liaison
- > Simple install and transferable
- > Internal backup battery
- > 5 year warranty

About Skytag

Skytag are now largest independent stolen vehicle recovery company in the UK, providing state of the art location equipment to recover your property quickly and efficiently. With an outstanding recovery record and an 11 minute fastest record, they are proud to offer a service second to none. With unique features like monthly operation checks and direct police access to live location information.

The Skytag device is a very small covert unit designed to be hidden in a vehicle, self installation enhances the covert nature of the product as everyone will put it somewhere different, making it virtually impossible to find, this also reduces costs and makes the unit easily transferable from vehicle to vehicle with no charges.

The device is smaller than a computer mouse and contains a GPS chip that can pin-point its location on the planet to within 5 metres. The device also contains a module that communicates this position to us via the GPRS data network. So we know exactly where your vehicle is in the event of a theft.

Our unit comes with the peace of mind of full worldwide cover and is IP65 waterproof. The device has an inbuilt backup battery that lasts 3 days should the vehicle battery be disconnected. It also alerts us when the battery has been disconnected; we can even tell when the vehicle battery is running low, ensuring continuous operation.



Skytag Packages

Standard Tracking

£6.99/month - payments to Skytag
Initial 3 months service included. Standard service includes battery disconnect alerts, tracker battery low power alert. Monthly health check and email notification. Worldwide coverage. 24 hour crime line with police liaison to recover your vehicle.

Active Monitoring

£10.99/month - payments to Skytag
Initial 3 months service included. Standard Tracking service plus active movement alerts.
'LeisureSafe' is designed for leisure vehicles which are used 2-3 times a week, 'LeisureSafe' is fully automatic with no requirement to remember to turn on or off. A bespoke zone is created where the vehicle is normally stored. If the vehicle moves out of this zone during the protected hours, alerts are sent direct to your mobile phone, your landline, text and email.

'NightSafe' is designed for everyday use vehicles where you need protection during the vulnerable night hours. Using a zone similar to 'LeisureSafe' the system alerts leaving the 'Safe Zone' during the armed period.

Live Tracking

£12.99/month - payments to Skytag
Live Tracking has all the features of the active monitoring service with the addition of user designed zones, speed alerts and the ability to log in from any internet enabled device and see the vehicle updated every 5 minutes with the ignition wired installation, or every 20 mins with standard fitting. "Liveview" service includes unlimited email alerts and 10 direct telephone alerts per week.

X-Column



DA9013

One thing that is common to virtually all stolen Land Rovers is that the column steering lock has been broken. It is normally broken by removing the lock barrel as this is surprisingly quick - the vehicle can then often be started with a screwdriver. This neat solution is a sleeve for the lock barrel assembly machined out of steel. It is strong enough to prevent the barrel being removed or the end broken off.

nothing to lock or unlock

The best thing about this solution is it's completely passive - i.e. nothing to lock or unlock. It stays permanently fitted to the vehicle providing 24 hour protection and deterrent value. The column lock will fit all Defenders LHD or RHD - up to 2014, including Puma/Tdci. One exception is that some ex-military vehicles do not have a steering lock. While the column lock will fit - it serves no purpose as there is nothing for it to protect.

Tamper Proof Nuts & Bolts

DA7333



Ensure your precious accessories remain firmly on your Land Rover by using a set of these tamper proof nuts and bolts. Ideal for securing your winch and front bumper. Each set contains either 4 nuts or bolts and 1 key.

- DA7330 M6 nut set & key
- DA7331 M8 nut set & key
- DA7332 M10 nut set & key

DA7332



- DA7333 M10 x 110 bolt set & key
- DA7334 M10 x 35 bolt set & key

Locking Fuel Cap



DA1227

Discovery 2
Locking fuel cap
Supplied with 2 keys.

Add some extra protection to your fuel.



Security Marking Kit



DA8533

The International Security Register (ISR) system has proved successful in deterring and detecting theft and fraud for over 30 years. It works on the principle that if a vehicle's windows and parts are marked using robust techniques and details are recorded on a secure database - supported by a 24/7 verification service - criminals stealing the vehicle will run a real risk of being caught and prosecuted. Each mark applied to a vehicle will contain a unique 8-digit code, the ISR logo and www.isrcodecheck.com

Pack Components

- > Full instructions on marking and registering a Land Rover are in the security marking kit.
- > 8 vinyl stencils, fluid and brush for marking windows.
- > 2 warning decals.
- > 2 sets of 6 UV self-etch labels for application to painted metal body panels.
- > 2 sets of 7 ultra-destruct labels with UV fluid and applicator for identifying plastic parts.
- > A set of three Britpart branded security tags for increasing the chance of items that are so often mislaid, being returned to the owner.
- > A Britpart branded ISR customer contact card.

Registration of Vehicle and Owner Data on the ISR

The vehicle owner - or the dealer - would complete the registration process online via the Britpart registration page at www.TheISR.org then select "All Vehicles" then "Vehicles" followed by "Britpart Registration Form" entering the unique code together with the vehicle make, model, colour, VIN and VRM together with the owners name and contact details. If an email address is supplied, an automated acknowledgement of registration would be sent. The code for the security tags would be automatically recorded.

Reducing the risk of your Land Rover being stolen or cloned.

More details of the kit can be found at www.britpart.com/security

X-Defend Pedal Lock



DA6601



DA6601 NEW Right hand drive
DA6602 NEW Left hand drive
 Defender - up to Td5 without air-con

The X-Defend Pedal Lock prevents the clutch, brake and throttle pedal from being operated, making a vehicle almost impossible to drive! Unlike other pedal locks, this remains bolted to the floor of the vehicle. When not in use, it folds flat on the floor and seat box, forming the floor of the cab. In this position it can be covered with your usual floor mat. This means you don't have to store a 20kg lump of metal which could be lethal if it hit you in the event of an accident or while off-roading. It also means that locking is incredibly quick. Just release the catch which holds it against the seat box and lock into position. A 10mm thick steel claw grabs the brake pedal shaft and ratchets in tight against it. It can be locked in a couple of seconds! To unlock turn the key which releases the pedal and fold flat on the floor. The Pedal Lock is supplied in tough, corrosion proof 304 stainless steel and uses formed hinges with a 6mm stainless pin. It is supplied with an anti-drill, British made Lowe & Fletcher RPT Lock. **Notes** - This does NOT fit Series/Defender - 2007 onwards. As not all Defenders are the same and build tolerances are at best acceptable it may be necessary to either relocate the bonnet pull bracket (you can drill out the spot welds and re-attach with pop rivets) or better still replace with the later Td5 type bonnet pull (FSC000050PMA). We have discovered that because Land Rover had no set place to fit the early type bracket it sometimes fouls the pedal lock.

Hinge Guards



DA1398 NEW 2-door kit
DA1399 NEW 4-door kit

The Bombproof Hinge Guard is built to exact specification and was developed to fit all Defender models and years. It has been engineered for maximum protection and ease of fitment. Each Hinge Guard kit consists of two CAD engineered stainless steel plates which fit inside of each hinge point, restricting outward movement of the door with the bulkhead bolts removed. Fitting the Hinge Guards is incredibly easy with comprehensive fitting instructions supplied. Each door kit can be easily fitted in 20-30 minutes. After installation, only the top of each plate can be seen, providing an unobtrusive modification and deterrent to would-be thieves.

Features

- > Notched upper guard - fits neatly around the dash padding without compromising security.
- > Custom folds - each plate has a carefully measured, very small offset to allow it to close around the door frame without tearing the door seal.
- > High-Grade 304 Stainless Steel - 2mm thick: thin enough to fit unobtrusively, more than thick enough to protect your hinges.
- > Individually profiled - lower and rear hinges profiled for a perfect fit across all variants.



DA1399

EXCLUSIVE to Britpart!



DA1412

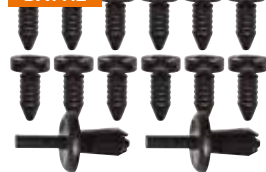

Defender door fitting kit. Ideal to keep handy if removing the door cards at any time. Front or rear single door. 2 x Lokut-nut 12 x fasteners
DA1411 NEW Grey
DA1412 NEW Black

Radiator Muffs



DA4025BLACK



DA2160BLACK



DA2161BLACK



DA2157



DA2163



DA2162



DA2153

Series 2/Series 2A - early models
DA4025BLACK Black edging
DA4025BLUE Blue edging
DA4025GREEN Green edging

Series 2A - late models/Series 3
DA2160BLACK Black edging
DA2160BLUE Blue edging
DA2160GREEN Green edging

Defender
DA2161BLACK Black edging
DA2161BLUE Blue edging
DA2161GREEN Green edging

Discovery
DA2153 Black edging
DA2157 Discovery 1 - up to LA
DA2163 Discovery 1 - MA onwards
 Discovery 2
 - square headlights
DA2162 Discovery 2
 - round headlights

Note - The radiator muffs are black with either black, blue, brown or green coloured edging.

Control the flow of air into your radiator with a quality British made radiator muff!

Camping Equipment

Fridge Freezers



DA6545

35L Portable ARB Fridge Freezer

Great for short trips or as a second fridge, the 35L Fridge Freezer suits many compact SUV's due to its low height and small footprint.

Capacity 35 litres (50 x 375ml cans)
 Cooling capacity +10°C to -18°C
 Weight 20.7kg
 External dimensions 428mm (H) x 380mm (W) x 705mm (D)
 Internal dimensions Fruit & dairy compartment: 126mm (H) x 285mm (W) x 151mm (D) & Main compartment: 321mm (H) x 285mm (W) x 337mm (D)
 Power - Built-in 12/24V DC and 100-240V AC power with integrated battery protection system

DA6546

47L Portable ARB Fridge Freezer

Suitable for many medium to large SUV's, the class leading 47L ARB Fridge Freezer is your perfect travelling companion.

Capacity 47 litres (72 x 375ml cans)
 Cooling capacity +10°C to -18°C
 Weight 22.5kg
 External dimensions 508mm (H) x 380mm (W) x 705mm (D)
 Internal dimensions Fruit & dairy compartment: 206mm (H) x 285mm (W) x 151mm (D) & Main compartment: 401mm (H) x 285mm (W) x 337mm (D)
 Power - Built-in 12/24V DC and 100-240V AC power with integrated battery protection system

DA6547

60L Portable ARB Fridge Freezer

Perfect for family trips or off road touring, the 60L Fridge Freezer features a low profile to suit roller drawer systems, larger 4WDs, boats & camper trailers.

Capacity 60 litres (90 x 375ml cans)
 Cooling capacity +10°C to -18°C
 Weight 24.5kg
 External dimensions 428mm (H) x 450mm (W) x 845mm (D)
 Internal dimensions Fruit & dairy compartment: 126mm (H) x 355mm (W) x 151mm (D) & Main compartment: 321mm (H) x 355mm (W) x 477mm (D)
 Power - Built-in 12/24V DC and 100-240V AC power with integrated battery protection system



4X4 ACCESSORIES

ARB products available in the UK only.

Internal features

- > **Dairy compartment** - optimised internal capacity includes separate compartment for fruit and dairy products.
- > **Reversible basket with divider** - multiple storage options by separating fridge contents or alternatively allowing longer items to be positioned along the length of the cabinet.
- > **Drain plug** - integrated into fridge base for effortless cleaning.
- > **Integrated evaporator** - designed as an integral part of the interior cabinet, ensuring simplified cleaning and optimum use of internal storage space.
- > **Internal LED light** - low power draw LED light with magnetic switch turns off when lid is closed.

Canvas Transit Bag

The ARB transit bag shields your fridge from dents and scratches while also providing additional insulation in extreme temperatures. Made of tough, durable canvas, the functional ARB transit bag features a handy side pocket for items such as the power cord or instruction booklet, as well as openings for the fridge's rubber feet, power cables and drain plug hole.

- DA6820** 35 litre bag
- DA6821** 47 litre bag
- DA6822** 60 litre bag

Fridge Freezer Remote Monitor



DA8933

The ARB Remote Fridge/Freezer Monitor allows you to monitor the operating condition of your ARB fridge/freezer from the comfort of your driving seat.

- > Multiple receiving channels for minimised transmission disruptions.
- > Large easy viewing backlit display.
- > Ability to monitor 2 ARB fridge/freezers.
- > 30m (100ft) line of sight or 15m(50ft) interrupted transmission.
- > Quick release bracket for easy removal of LCD display.
- > Temperature displayed in either °C or °F.
- > Power supply 12V.

External features

- > **Secop compressor** - highest quality, Secop Compressor with smart electronic control system enables rapid cool down to target temperature.
- > **Durable detent hinge** - stainless steel detent hinge ensures the lid can be easily released and securely slid back into place.
- > **Rear clips** - rear clips secure 12/24v and 100-240v cables, preventing the plug from being accidentally disconnected.
- > **Lid with integrated seal** - tough, two piece injection moulded lid incorporates a recessed seal, preventing excessive wear and damage.
- > **Front latch** - simple to use, large over-centre cam lock latch provides a positive seal between the lid and cabinet for maximum cooling efficiency.
- > **Control panel** - easily accessible, recessed front control panel with maintenance-free digital temperature display (no dedicated battery required).
- > **Recessed handles** - powder coated steel handles, engineered to double as tie down points.
- > **Durable case** - powder coated, robust zinc steel cabinet sides designed to withstand extreme off road conditions.
- > **Rubber feet** - integrated into fridge base for increased grip and stability.



Cool Bag

VUP100140L

Waecol electric cool bag
 Powered by the 12 volt auxiliary socket. Thermostatically controlled temperature. Easy clean interior surfaces. Vertical space for standing 2-litres bottles. Exterior in high quality Oxford nylon, side in hard-wearing rubber coated nylon.

Technical data

- > Application: 12 volts
- > Power input: Approx. 3 A/36 W
- > Capacity: 14 litres
- > Cooling capacity: Max. 25°C below ambient temperature
- > Insulation: 20 mm solid polyurethane foam; 10mm expanded foam
- > Cooling unit: Thermoelectric elements, cooling only
- > Size: Height 380mm x length 380mm x width 220mm



Photo courtesy of Mervyn Church



Tent, Shade & Shelter



Awnings

Easy to mount and operate, these self standing, retractable awnings fit onto the side of a roof rack and are conveniently stored for immediate use on arrival. Specifically designed for harsh outback conditions, the awnings feature height adjustable, telescopic legs and provide fast and convenient protection from the elements. Easily mounting to the side of most roof racks or roof bars, the awning is secured in a heavy duty nylon reinforced PVC bag. Constructed from tough PU coated 300gsm poly/cotton rip stop canvas, the awnings are fully waterproof and offer a UVP 50+ rating.

DA6826	2,500 x 2,500mm
DA6827	2,000 x 2,500mm
DA6828	1,250 x 2,100mm



Wind Break

Designed to angle out from ARB awnings, these wind breaks offer additional protection from the rain while also providing extra shade and sun protection. ARB wind breaks are ideal for creating extra protection and storage for items like swags and chairs under the awning. Manufactured from lightweight PU coated 300gsm poly cotton canvas. Waterproof and UV protected with a UVP 50+ rating. Tie down points for each wind break to further secure the awning.

Note - Side awning not included - DA6844

DA6829	2,500mm
DA6844	2,100mm
DA6840	2,000mm



Awning Room with Floor

Designed to function as a fully enclosed room, the awning with floor provides additional weather protection and privacy. The awning room can be used with ARB awnings and features a durable floor, two large mesh windows with roll up blinds and a zippered door with both solid and mesh panels. It is fully enclosed with an integrated roof that hangs just below the main awning canvas. Rear wall features a central door that can be used to directly access the vehicle rear door or canopy depending on awning mounting position. Access points for 12v/240v power leads. Supplied with hardened steel pegs and adjustable tension straps.

DA6833	2,500 x 2,500mm
DA6832	2,500 x 2,100mm
DA6819	2,000 x 2,100mm



Three Wall Set

Comprised of three individual walls that wrap around the outside of ARB awning legs, the three wall set is both waterproof and UV protected. Manufactured from lightweight PU coated 300D Oxford polyester, two walls feature windows made from half mesh and half clear PVC, while the right hand wall includes a zippered door that can be rolled up out of the way. Connected via a zip, each wall can be used individually, as a pair or set. Available to suit ARB awnings. Supplied with hardened steel pegs and adjustable tension straps. No rear wall allows for full access to the vehicle. Mud/storm flaps at the bottom of each walls.

DA6835	2,500 x 2,500mm
DA6834	2,500 x 2,100mm
DA6839	2,000 x 2,500mm



Mosquito Net

ARB mosquito nets are manufactured from double stitched, 48gsm midge proof mesh and are available for ARB awnings. Providing a comfortable area to eat and relax, this updated version is now larger and includes a mud/storm flap to reduce grass seeds and other debris from collecting in the lower section of the mesh. Hardened steel pegs are supplied to firmly anchor the room to the ground via adjustable tension straps.

DA6830	2,500 x 2,500mm
DA6831	2,000 x 2,500mm



DA8981

Simpson Rooftop Tent

1,400mm wide x 2,400mm long x 1,300mm high
The ARB Simpson III Rooftop Tent will provide the ultimate in ease and convenience when travelling. Unfolding in minutes, a rooftop tent provides sleeping quarters off the ground, protected from the elements. Spacious and comfortable, all bedding can remain inside the tent during the journey, freeing up vital storage space in the vehicle, and allowing the tent to be quickly and easily packed away. More images available online.

Features

- > Incorporates an updated design and new materials for better strength, rigidity and water resistance.
- > Manufactured from high quality, poly/cotton fabric.
- > Incorporates Oxford polyester flysheet with excellent water shedding ability.
- > Sturdy aluminium retractable ladder.
- > High density bonded chip foam mattress with removable cover for increased comfort and durability
- > Incorporates pull out veranda.
- > Insect screened windows and door.
- > UV stabilised laminated PVC cover.
- > Bungee cord system to assist when closing.
- > Easily mounted to ARB's purpose designed roof rack.
- > Can be configured to unfold off either the side or off the rear of the vehicle.
- > All aluminium components feature an anodized finish for improved corrosion resistance and appearance.
- > Comes complete with mounting hardware, wrenches, ladder, travel cover and comprehensive instructions.
- > ARB awnings can also be paired with the rooftop tent.

Camping Chair



DA8929

ARB Air Locker camping chair is rated to 120kg and has a host of features, including a padded seat and backrest, convenient drink holder pouch, side pocket with Velcro flap for your keys, wallet or other small items, and a mesh magazine pocket on the rear of the backrest. Manufactured from durable nylon Oxford weave material, the chair also comes with a matching carry bag for compact storage and transportation.



Photo courtesy of Edwin Remsburg



4X4 ACCESSORIES

ARB products available in the UK only.

Gifts & Merchandise

T-Shirts

UNION JACK FLAG



BECAUSE THE EARTH...



Union Jack Flag
Grey t-shirt
DA8052 Medium
DA8053 Large
DA8054 X-Large
DA8055 XX-Large



Because the Earth...
Grey t-shirt
DA8056 Small
DA8059 X-Large
DA8060 XX-Large



WHEELS



HEADLIGHTS



Wheels
Grey t-shirt
DA8061 Small
DA8062 Medium
DA8063 Large
DA8064 X-Large
DA8065 XX-Large



Headlights
Grey t-shirt
DA8066 Small
DA8067 Medium
DA8068 Large
DA8069 X-Large
DA8070 XX-Large



STEERING WHEELS



Exclusive to...

BRITPART

- > 100% cotton
- > Reactive dyed
- > Crew neck
- > Taped shoulder to shoulder
- > Twin needle stitching on neck & shoulders
- > Enzyme washed for extra soft hand-feel and reduced shrinkage

A great gift idea!

Steering Wheels
Beige t-shirt
DA8071 Small
DA8072 Medium
DA8073 Large
DA8074 X-Large
DA8075 XX-Large



For a better image of the t-shirt designs go to www.britpart.com/tshirt

Britpart Clothing

T-SHIRT



POLO SHIRT



SWEAT SHIRT



LOGO ON BACK OF POLO & SWEATSHIRT



FLEECE



FLEECE BODY WARMER



DA8013



DA8021



T-Shirts

DA8029	Medium
DA8028	Large
DA8020	X-Large
DA8050	XX-Large

Hats

DA8013	Ski hat
DA8021	Baseball cap

Polo Shirts

DA8045	Small
DA8005	Medium
DA8006	Large
DA8007	X-Large
DA8008	XX-Large
DA8080	XXX-Large

Sweatshirts

DA8046	Small
DA8009	Medium
DA8010	Large
DA8011	X-Large
DA8012	XX-Large
DA8081	XXX-Large

Fleeces

DA8047	Small
DA8040	Medium
DA8041	Large
DA8018	X-Large
DA8019	XX-Large

Fleece Body Warmers

DA8077	Small
DA8078	Medium
DA8079	Large
DA8049	X-Large

Britpart Merchandise



DA8000
Mouse & mug mat set



DA8002
Key ring - karabiner style



DA8027
Key ring - bottle opener



DA8017
Drawstring bag



DA8003
Ball point pen - pack of 10
DA8003X
Ball point pen - pack of 100



Note
Picture shows both sides

DA8004
Mug - single



DA8015
Stainless steel travel mug



DA8025
Ice scraper



DA8016
5" Teddy bear



DA8082
7" Panda bear



DA8024
300mm Ruler



DA8038
Note book - 190 x 250mm



DA8036
Pen pot



DA8037
Pocket LED torch



DA8014 NEW
Die cast metal Defender with working headlights. 16GB. Simple, portable, personal storage with a high reading & writing speed.



DA1229
Defender stress toy



DA8043
Credit card wallet



DA8042
Air freshener - cool wave scent. Pack of 5



facebook.com/britpart



Photo courtesy of Jundio Salvador

Land Rover Merchandise



LRDCA3EVOG
Range Rover Evoque - 3 Door
1:43 scale die-cast model



LRDCA5EVOG
Range Rover Evoque - 5 Door
1:43 scale die-cast model.



LRDCADISCO
Discovery 4
1:43 scale die-cast model.



LRDCA405
Range Rover L405
1:43 scale die-cast model.



LRDCA494
Range Rover Sport - 2014 onwards
Chile Red
1:43 scale die-cast model



LRDCA494G
Range Rover Sport - 2014 onwards
Corris Grey
1:43 scale die-cast model



LRSS12RHW
Premium soft and supple fine and heavy grained black leather wallet with Alcantara lining detail and multi-card and note compartments.



LRSS12RCCW
Premium soft and supple fine and heavy grained black leather card holder with Alcantara lining detail and multi-card sections.



LRTOAHT30UK 30cm
Children's bears with soft plush fur and Land Rover branding to their neck ribbon.



LRAVENTUREBEAR
Made from soft touch, plush fur and with a Land Rover logo on his shirt. Suitable for ages 3 or more.

Ideal *birthday* or *Christmas* gifts for any *Land Rover* enthusiast - whatever their age!



LRUGNIP NEW
Features a magnetic main closing mechanism. Alcantara lining and grained black leather. Suitable for iPad, iPad2 and iPad Air.



LRSPANNS	Land Rover	Navy	Small
LRSPANNL	Land Rover	Navy	Large
LRSPANGS	Land Rover	Black	Small
LRSPANGL	Land Rover	Black	Large
LRSPANRRSL	Range Rover Sport	White	Large



Hard cover lined 152 page notebook featuring Land Rover or Range Rover Sport branding on the cover and page details. These notebooks also feature an expandable inner pocket.



LRSPABACBP
Contemporary styled and polished chrome Cross ballpoint pen with subtle Land Rover branding.



LRUNIJACMUG14
Land Rover Union flag mug. Provides a unique take on the Land Rover logo.



LRICONMUG14
Icon mug. This mug features the terrain response icons from Land Rover vehicles.



LRCORPMUG14
Land Rover logo mug.



LRCEAHUEG
Green stoneware mug with raised embossed HUE 166.



Photo courtesy of Marco Simola

Land Rover Merchandise - continued



LAKR272SLA
Land Rover silver oval key ring embossed with the Union flag.



LRKRALS
Discovery Sport key ring.



LRKRALLK
Brown & ivory



LDKR925IVA NEW
Ivory



LDKR928BKA NEW
Black

Chromium plated keyring with matt finish & double thickness leather loop keyring with pull to twist mechanism.



LRKRANHUE
Cast metal enamelled alloy keyring taking inspiration from the original licence plate of the Series I, the HUE 166.



UMAGBG
Manual opening golf umbrella with lightweight fibreglass shaft and windproof system. Polyester single thickness blue canopy with grey logo print on one panel.



LRUMAGBR
30" automatically opening golf umbrella. Grey outer canopy with contrasting red lining and fibreglass frame.

Ideal *birthday* or *Christmas* gifts for any *Land Rover* enthusiast - whatever their age!



LACH015BLA Bright blue
100% cotton otterman baseball cap. 3D silicone Union Flag oval and a Land Rover branded buckle.



LACH015GMA Grey



LACH015RDA Deep red



LBCH113NVA Navy
100% cotton otterman baseball cap. 3D silicone Union Flag oval, Terrain Response icons and a Land Rover branded buckle.



LBCH224BNA Brown
100% waxed cotton for all-weather protection, this classic 5-panel navy cap features a Heritage logo on the front and a leather expedition patch to the right. Metal eyelets offer breathability, while complementing the metal finish fastening.



LBCH224NVA Navy



NACH295ORA Orange
This dual branded Land Rover and Nike Ultralight cap with Dri-fit technology offers style and provides a shield for your eyes from the sun.



LBCH223NVA Navy Bush Hat
Offering durable, all-weather defence, this waxed cotton bush hat is a key element of any expedition wardrobe. Features contrast colour taping, top stitching rim detail, large metal eyelets, drawingstring cord and a distressed print logo.



Photo courtesy of Wayne Williams

Die-cast Models



Collectable and detailed die-cast metal 1:18 scale model

DA1219 Range Rover Evoque - 2-door Red
This very detailed die-cast Evoque replica is not a toy and is not suitable for children under 14. The model is 245mm long x 120mm wide x 95mm high. It has detailed engine and interior parts with opening doors, boot and has a button under the chassis to open the bonnet, even the side mirrors fold on this superb scaled replica which is a must for all collectors and enthusiasts.

Collectable and detailed die-cast metal 1:24 scale models

DA1223 Defender - 2007 onwards White
DA1221 Discovery 4 Silver
DA1222 Range Rover Evoque - 2-door White
DA1220 Range Rover L322 Silver
DA1397 Range Rover Sport **NEW** Chili Red
DA1413 Jaguar F-Pace **NEW** Red

Collectable and detailed die-cast metal 1:76 scale model

DA1232 Series 1 Flat Back Green
DA1324 Defender 90 Tamer Blue
DA1323 Range Rover Evoque Baltic Blue
DA1318 Range Rover Evoque **NEW** Firenze Red
DA1322 Range Rover L405 Santorini Black
DA1335 Defender Heritage set



Photo courtesy of Natasha Bridges

Haynes Internal Combustion Engines

DA4817



DA4310



DA4817

Build a fully functional, motorised model of a V8 petrol engine. Features sound recorded from a real V8 and illuminating spark plugs. The kit contains nearly 300 pieces and all that you need to assemble the model. It is supplied with a Haynes style manual giving you clear step-by-step instructions as well as interesting information about real V8 engines.

DA4310

Build a realistic working model of a combustion engine. Includes light and sound features, light up spark plugs, moving pistons, valve gear, fan belt and 'Haynes Manual'. Finished model size - 180 x 270 x 140mm (H x W x D)

Build a working model of an engine.

Starting Handle

218508

Starting handle for Series vehicles

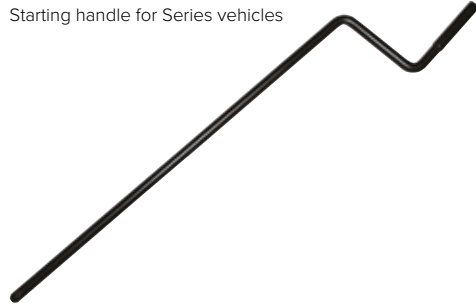

Heavy-Duty Wiper Blades

DKC500010PMD

Discovery 2
Front
Pair



VUB500900

Freelander 1
Front
Pair



Note - These winter wiper blades should not be used at high speeds, it is a winter blade designed for harsh conditions.

Britpart Distributor Merchandise



EXTERIOR STICKER

High tack vinyl gloss stickers
300 x 90mm Qty 20

INTERIOR STICKER

Self-cling window stickers
220 x 70mm Qty 20

LOGOBOARD

Britpart logo on 3mm foamex board
900 x 300mm Qty 1



DEFENDER STICKER

Britpart Defender stickers
100 x 60mm Qty 20



TRAYBACK STICKER NEW

Britpart Trayback stickers
100 x 60mm Qty 20



Britpart accessory catalogue

CATALOGUE Qty 5

DA7999 NEW Qty 1



SERVICE KIT LEAFLET

Britpart service kit leaflet
99 x 210mm Qty 25



CARRIER BAG

Britpart branded carrier bags
380 x 470mm Qty 50



DA8042PACK

Britpart branded air freshener
Cool wave scent
100 x 65mm Qty 25



POSTER SET

Britpart A2 poster set
380 x 470mm Qty 8

Please ask the sales team for details...



DA8023PACK

Britpart key rings Qty 25



DA8048

Britpart branded note pads
A5 with 50 pages per pad Qty 10



DA8039 NEW

Britpart branded sticky pads
125 x 75mm with 50 pages per pad Qty 10



facebook.com/britpart

Part Number	Page Number	Part Number	Page Number	Part Number	Page Number	Part Number	Page Number	Part Number	Page Number
1357035	171	532268	162	ANR2563PY	133	DA1003	93	DA1156	42
1387695SENSOR	171	535173	138	ANR2563PY-YELLOW	133	DA1004	93	DA1157	214
201691	56	537179	42	ANR2763MMM	45, 46	DA1043	173	DA1158	52
204-591-01	201	548205PY	133	ANR3285PY	133	DA1044	173	DA1159	169
204-591-02	201	548205PY-YELLOW	133	ANR3285PY-YELLOW	133	DA1045	173	DA1160	201
20-6000-755	36	552818PY	133	ANR3304HD	129	DA1057	169	DA1161	201
218453	182	552818PY-YELLOW	133	ANR3305PY	133	DA1057PLUG	169	DA1162	199
218508	238	552819PY	133	ANR3305PY-YELLOW	133	DA1059	20	DA1164	130
234532	189	552819PY-YELLOW	133	ANR3332PY	133	DA1062	49	DA1165	166
241283	138	559822	182	ANR3332PY-YELLOW	133	DA1062AMBER	49	DA1166	166
242139	57, 60	562631	138	ANR3410PY	133	DA1062BLUE	49	DA1167	166
242863	138	562632	138	ANR3410PY-YELLOW	133	DA1062COVER	49	DA1168	224
243123	138	562731SS	123	ANR3631MNH	44	DA1062FOGA	49	DA1169	224
244449SS	123	562858SS	123	ANR3635	56	DA1062FOGW	49	DA1170	69
251323X	189	563165/6/7/8	168	ANR3973	43	DA1063	49	DA1171	12
264195SS	123	568858PY	133	ANR4188EYELLOW	132	DA1064	49	DA117K	12
264563	138	568858PY-YELLOW	133	ANR4188PY	132	DA1065	201	DA1172	166
265627	138	569746PY	133	ANR4188PYE	132	DA1070	179, 182, 183	DA1173	200
271581	164	569746PY-YELLOW	133	ANR4188PY-YELLOW	132	DA1070SS	183	DA1174	99
279678	138	572068PY	133	ANR4189EYELLOW	132	DA1071	206	DA1174GM	99
279679	138	572068PY-YELLOW	133	ANR4189PY	132	DA1072	206, 208	DA1174HM	99
302532X	189	572180PY	133	ANR4189PYE	132	DA1073	206	DA1174SM	99
306460	182	572180PY-YELLOW	133	ANR4189PY-YELLOW	132	DA1077	49	DA1176	200
320045X	189	575580PY	133	ANR4489	93	DA1077G	49	DA1178	90
320647	81	575580PY-YELLOW	133	ANR4583PM	43	DA1079	13	DA1179	216
320647CB	81	576521	90	ANR4583SILVER	43	DA1080	49	DA1182	169
320647CG	81	576844	163	ANR4636PM	43	DA1080G	49	DA1183	169
320647LCS	81	579408	56	ANR5307MNH	44	DA1081	65	DA1185	169
320647RPI	81	586438LED	50	ANR5593PM	43	DA1082	65	DA1186	130
320647T	81	589783	50	ANR6091	42	DA1087	115	DA1187	17
320674	81	598540SS	123	ANR6094L	42	DA1087FL	115	DA1188	17
320674CB	81	599378SS	123	ANR6947PY	133	DA1088	115	DA1189	200
320674CG	81	602153A	170	ANR6947PY-YELLOW	133	DA1089	30, 31	DA1191	49
320674LCS	81	602154A	170	ASB710260	179	DA1090	31	DA1192	49
320674RPI	81	606435	200	ASB710270	179	DA1091	31	DA1193	16
320674T	81	606683S	166	ASR1186	180	DA1092	31	DA1194	16
320698	81	606696S	166	ASR1187	180	DA1093	31	DA1195	167
320699	81	624196SS	123	ASR1594	180	DA1108	115	DA1196	167
320726	81	67187	56	ASR1595	180	DA1108TDI	115	DA1197	16
320737	81	79221X	189	AWR5698RPI	80	DA1109	115	DA1198	16
320737CG	81	90577434PY	133	AWR5699RPI	80	DA1109DEF	115	DA1199	132
320737LCS	81	90577434YELLOW	133	AWR5700RPI	80	DA1109DIS	115	DA1200DEF	169
320737RPI	81	AAP817	173	AWR5701RPI	80	DA1111	200	DA1200DEFG	169
320737T	81	AB614061X	189	AWR5702RPI	80	DA1112	115	DA1200DIS	169
320853	182	AEU1523	181	AWR5708RPI	80	DA1113	173	DA1200DISG	169
320854	182	AEU1525	181	BIC710260	179	DA1114	184	DA1203	84
330037	182	AEU2147LX	168	BL4136BUSH	141	DA1115	199	DA1204	84
330038	182	AFP710120SS	220	BTR1759LCS	80	DA1116	199	DA1205	220
330326	182	AFU1075X	189	BTR277	17	DA1117	200	DA1207	89
330327	182	AFU1900X	189	BTR3793LCS	84	DA1118	200	DA1208	89
330336	182	ALQ710020K	12	BTR7895	70	DA1119	201	DA1209	201
330337	182	ALR1742	179	BTR7896	70	DA1120	199	DA1211	139
330422	84	ALR1743	179	BTR7897	70	DA1121	199	DA1212	139
330426	182	ALR5822	180	BTR7898	70	DA1122	190	DA1213	163
330427	182	ALR5823	180	BTR7959LCS	84	DA1123	143	DA1214	163
330999	79	ALR6121	179	BTR9712LCS	84	DA1125	202	DA1215	131
331110AG	79	ALR6122	179	BTR9712LOY	84	DA1126	56	DA1216HD	176
331110SA	79	ALR6272	180	BTR9712PMA	84	DA1127	169	DA1217	40
331113AG	79	ALR6677	179	BX110095MX	189	DA1128	128	DA1219	237
331113SA	79	ALR6678	179	BYH500100X	189	DA1129	128	DA1220	237
331259AG	79	ALR6681	180	CAB500070PMA	32	DA1129ADJ	128	DA1221	237
331259SA	79	ALR6682	180	CAB500130PMA	32	DA1129G	128	DA1222	237
331260AG	79	ALR6852	179	CARRIER BAG	238	DA1129KIT	128	DA1223	237
331260SA	79	ALR8519	180	CAS000150PMA	17	DA1129ULTRA	128	DA1224	89
331371AG	79	ALR8520	180, 181	CAS100900	17	DA1130	128	DA1225	89
331401	67	ALR8572	180	CAS100910	17	DA1131	179, 182, 183	DA1227	229
331670	67	ALR8573	180	CAS100920	17	DA1132	224	DA1229	234
332951	79	ALR8576	180	CAS100930	17	DA1132P	224	DA1230	40
337791	182	ALR8577	180	CAS500010PCL	17	DA1133	224	DA1231	40
337792	182	ALR8710	183	CAS500060PMA	17	DA1133P	224	DA1232	237
345510	40	ALR9803	179	CAS500070PCL	17	DA1134	224	DA1233	131
345985	13	ALR9804	179	CAS500180PMA	17	DA1134P	224	DA1234	139
345985P	13	ALR9877	180	CAS500190PMA	17	DA1135	224	DA1235	202
347474	182	AM605061X	189	CAT000180PMA	17	DA1136	224	DA1236	162
347475	182	AMR1515M	167	CAT101160	17	DA1137	224	DA1238	94
349943	80	AMR2341DELAY	167	CAT101170	17	DA1138	224	DA1239	94
349967	81	AMR3850	50	CAT500010PCL	17	DA1139	224	DA1239EU	94
390055	181	AMR3869M	167	CAT500060PMA	17	DA1140	20	DA1240	179, 183
390381	181	AMR6509W	51	CAT500070PMA	17	DA1141	164	DA1240SS	183
390382	181	AMR6510W	51	CAT500120PCL	17	DA1142	216	DA1241	176
391127	181	AMR6513LED	50	CAT500340PMA	17	DA1142B	216	DA1242	128
391141	181	AMR6514LED	50	CAT500350PMA	17	DA1143	49	DA1243	128
391546	181	AMR6515LED	50	CAT500360PMA	17	DA1143CL	49	DA1244	128
392222	181	AMR6515LEDCL	50	CAT500370PMA	17	DA114412V	50	DA1244G	128
392223	181	AMR6526	50	CAT500410PMA	17	DA114424V	49, 50	DA1245	128
395529	182	AMR6526LED	50	CAT500450PMA	17	DA1145	224	DA1245G	128
395530	182	AMR6526LEDCL	50	CAT500540PMA	17	DA1146	52	DA1246	128
396739	81	AMR6527	50	CATALOGUE	238	DA1147	200	DA1247	128
500289SS	123	AMR6527LED	50	CMB000411	218	DA1148	128	DA1248	128
503456SS	123	AMR6527LEDCL	50	CN100208L	189	DA1148CAP	128	DA1248G	128
504105G	164, 176	AMR6528	50	CN100508L	189	DA1149	128	DA1249	128
509045PX	189	ANR1721PY	133	CN100909	189	DA1152	216	DA1252	174
517469SS	123	ANR1721PY-YELLOW	133	CQB000140	179	DA1152B	216	DA1253	174
517588	138	ANR1799A	131	CVW500010	179	DA1153	201	DA1255	94
517589	138	ANR2056	179	CZQ000010LED	50	DA1155	202	DA1256	94

Part Number	Page Number	Part Number	Page Number	Part Number	Page Number	Part Number	Page Number	Part Number	Page Number
DA1257	214	DA1400	218	DA2056-300TDIHD	177	DA2225	94	DA2410S	113
DA1260	224	DA1401	218	DA2056-300TDI-M	177	DA2231	93	DA241150S	113
DA1260P	224	DA1402	218	DA2056-M	177	DA2232	40	DA241140S	113
DA1261G	169	DA1403	218	DA2057	177	DA2243	92	DA2411S	113
DA1262G	169	DA1404	218	DA2057-300TDI	177	DA2243EYE	92	DA2412150S	113
DA1263G	169	DA1405	218	DA2057-300TDIHD	177	DA2244	92	DA241240S	113
DA1264G	169	DA1406	218	DA2060	10	DA2248	92	DA2412S	113
DA1265G	169	DA1407	180	DA2061	10	DA2249	21	DA2413	113
DA1266	221	DA1408	180	DA2062	10	DA2250B	21	DA2413150S	113
DA1267	69	DA1409	98	DA2063	10	DA2274	40	DA241340S	113
DA1268	12	DA1410	98	DA2064	10	DA2274CABLE	40	DA2413S	113
DA1269	12	DA1411	230	DA2065	10	DA2301	16	DA241440S	113
DA1270	215	DA1412	230	DA2066	10	DA2310	32	DA2414S	113
DA1271	215	DA1413	237	DA2067	10	DA2311	32	DA241840S	113
DA1272	115	DA1417	40	DA2068	10	DA2312	32	DA2418S	113
DA1273	50	DA1500	146	DA2069	10	DA2315	32	DA2419	113
DA1274	49	DA1502	146	DA2070	10	DA2342L	218	DA241940S	113
DA1274CL	49	DA1504	146	DA2071	18	DA2342R	218	DA2419S	113
DA1275	183	DA1505	146	DA2090	84	DA2343L	218	DA242040S	113
DA1275SS	183	DA1508	89	DA2091	84	DA2343R	218	DA2420S	113
DA1277	176	DA1600	160	DA2096	84	DA2344	218	DA2421	113
DA1278	106	DA1810	77	DA2098	84	DA2351	77	DA242140	113
DA1279	106	DA1888	134	DA2099	182	DA2352	173	DA242140S	113
DA1280	106	DA1960	20	DA2112	168	DA2353	134	DA2421S	113
DA1281	106	DA1961	20	DA2112-1	168	DA2353G	134	DA2425	133
DA1282	106	DA1962	131	DA2112-2	168	DA2354	86	DA2426	133
DA1283	106	DA1963	215	DA2112-3	168	DA2354FUSE40A	86	DA2427	174
DA1285	125	DA1968	214	DA2112B	168	DA2355	173	DA2428	174
DA1286	14	DA1969	214	DA2112G-EARLY	168	DA2356	214	DA2430	46
DA1287	15	DA1970	214	DA2112G-LATER	168	DA2356B	214	DA2431	46
DA1288	15	DA1971	214	DA2113	168	DA2357	175	DA2432	46
DA1289	15	DA1972	214	DA2114	168	DA2357CP	175	DA2433	46
DA1290	15	DA1973	214	DA2114B	168	DA2357G	175	DA2434	46
DA1291	49	DA1974	215	DA2115	168	DA2357HD	175	DA2435	46
DA1292	49	DA1975	215	DA2116	182	DA2357HDG	175	DA2436	46
DA1293	122	DA1977	224	DA2118	56	DA2362	131	DA2437	46
DA1294	122	DA1980	197	DA2121	57	DA2363	131	DA2438	46
DA1300	169	DA1981	197	DA2122	60	DA2364	20	DA2439	46
DA1300G	169	DA1982	197	DA2123	56	DA2365	20	DA2440	84
DA1305	183	DA1983	197	DA2123A	56	DA2366	20	DA2441	84
DA1306	183	DA1985	197	DA2124	84	DA2369	175	DA2442	84
DA1307	19	DA1986	197	DA2125	58, 61	DA2370	175	DA2443	84
DA1307T	19	DA1987	197	DA2126	121	DA2372	138	DA2444	84
DA1308	19	DA1988	197	DA2126A	121	DA2373	138	DA2445	84
DA1308T	19	DA1989	197	DA2128	16	DA2374	95	DA2446	84
DA1309	183	DA1990	197	DA2129	60	DA2376	169	DA2447	84
DA1311	19	DA2001N	182	DA2130	16	DA2379	163	DA2450	46
DA1311T	19	DA2001O	182	DA2133	60	DA2379G	163	DA2451	46
DA1312	19	DA2002	182	DA2134	58, 61	DA2380	163	DA2452	46
DA1312T	19	DA2003	138	DA2136	57	DA2380G	163	DA2453	46
DA1313	19	DA2004	10	DA2137	57	DA2381	163	DA2454	46
DA1313T	19	DA2005	168	DA2138	58	DA2381G	163	DA2455	46
DA1318	237	DA2006	168	DA2141	168	DA2382	163	DA2456	46
DA1322	237	DA2007	182	DA2142	173	DA2382G	163	DA2457	46
DA1323	237	DA2008N	182	DA2142G	173	DA2383	163	DA2458	46
DA1324	237	DA2008O	182	DA2143	173	DA2383G	163	DA2459	46
DA1325	59	DA2009	182	DA2143G	173	DA2384	163	DA2460	46
DA1326	59	DA2012	60	DA2144	173	DA2384G	163	DA2461	46
DA1331	191	DA2013	182	DA2144G	173	DA2385	163	DA2462	182
DA1333	191	DA2014	182	DA2148	77	DA2385G	163	DA2463	182
DA1335	237	DA2015N	182	DA2149	76	DA2386	163	DA2464	182
DA1336	171	DA2015O	182	DA2153	230	DA2386G	163	DA2465	182
DA1337	169	DA2016	182	DA2155	173	DA2387	163	DA2466	78
DA1338	171	DA2017N	182	DA2156	182	DA2387G	163	DA2467	181
DA1339	171	DA2017O	182	DA2157	230	DA2388	163	DA2468	181
DA1340	171	DA2019N	182	DA2160BLACK	230	DA2388G	163	DA2469	181
DA1341	171	DA2019O	182	DA2160BLUE	230	DA2389	166	DA2470	181
DA1342	56	DA2021	42	DA2160GREEN	230	DA2390	40	DA2471	45
DA1343	43	DA2022	42	DA2161BLACK	230	DA2391	189	DA2472	45
DA1345	193	DA2023N	182	DA2161BLUE	230	DA2392	86	DA2473	45
DA1346	45	DA2023O	182	DA2161GREEN	230	DA2392FUSE50A	86	DA2474	45
DA1347	45	DA2024	179	DA2162	230	DA2394	86	DA2475	45
DA1348	20	DA2025	42	DA2163	230	DA2395	174	DA2476	45
DA1349	45	DA2026	42	DA2166	91	DA2396	179	DA2477	45
DA1350	45	DA2026N	179, 182	DA2167	91	DA2397	179	DA2478	45
DA1353	179, 182	DA2026O	179, 182	DA2170	91	DA2398	179	DA2479	169
DA1354	179, 182	DA2027	42	DA2171	91	DA2399	179	DA2479G	169
DA1355	179	DA2029	84	DA2172	91	DA2400150S	113	DA2479LR	169
DA1356	191	DA2030	84	DA2174	92	DA240040S	113	DA2480	84
DA1357	214	DA2035	76	DA2178	162	DA2400S	113	DA2481	84
DA1360	42	DA2035GREY	76	DA2182	91	DA2401150S	113	DA2482	84
DA1361	182	DA2035LCS	76	DA2186	131	DA240140S	113	DA2483	84
DA1362	182	DA2035MESH	76	DA2194	56	DA2401S	113	DA2484	84
DA1363	182	DA2035RPI	76	DA2195	56	DA2402150S	113	DA2485	84
DA1388	163	DA2035T	76	DA2196	56	DA240240S	113	DA2486	84
DA1389	163	DA2037	108	DA2197	56	DA2402S	113	DA2487	84
DA1390	208, 210	DA2037KY	108	DA2198	132	DA240340S	113	DA2488	45
DA1392	183	DA2039	169	DA2200	132	DA240440S	113	DA2489	45
DA1393	179	DA2050	10	DA2203	132	DA240540	113	DA2490	84
DA1394	178	DA2051	10	DA2204	132	DA240640S	113	DA2491	84
DA1395	178	DA2052	10	DA2206	121	DA240740S	113	DA2492	84
DA1396	178	DA2053	10	DA2210	162	DA240940S	113	DA2493	84
DA1397	237	DA2054	10	DA2211	162	DA2409S	113	DA2494	84
DA1398	230	DA2056	177	DA2215	40	DA2410150S	113	DA2495	84
DA1399	230	DA2056-300TDI	177	DA2220	132	DA241040S	113	DA2496	84

Part Number	Page Number	Part Number	Page Number	Part Number	Page Number	Part Number	Page Number	Part Number	Page Number
DA2497	84	DA2825SAND	73	DA3161	226	DA3356	168	DA4077	13
DA2498	183	DA2828BLACK	72	DA3162	226	DA3357	168	DA4086	179, 182
DA2499	183	DA2829BLACK	73	DA3163	162	DA3358	162	DA4088	48
DA2505	168	DA2830BLACK	73	DA3163G	162	DA3359	162	DA4088BULB	48
DA2506	168	DA2831BLACK	73	DA3163P	162	DA3360	174	DA4088C	48
DA2508	168	DA2832BLACK	72	DA3164	162	DA3361	174	DA4088COVER	48
DA2515	84	DA2838BLACK	72	DA3164G	162	DA3362	174	DA4088W	48
DA2516	84	DA2839BLACK	73	DA3164P	162	DA3363	174	DA4099	48
DA2517	84	DA2839SAND	73	DA3165	162	DA3364	174	DA4100	10
DA2518	168	DA2988	227	DA3165G	162	DA3365	174	DA4100B	10
DA2520	182	DA2990	31	DA3165P	162	DA3366	174	DA4101	24
DA2521	182	DA2991	31	DA3166	162	DA3367	168	DA4102	167
DA2522	179	DA2992	128	DA3166G	162	DA3368	168	DA4102RED	167
DA2523	179	DA2993	31	DA3166P	162	DA3369	168	DA4104	167
DA2524	179	DA2996	31	DA3167	162	DA340140S	113	DA4104RED	167
DA2525	179	DA2997	208	DA3167G	162	DA3401S	113	DA4105	164
DA2542	184	DA3000	40	DA3167P	162	DA3502	78	DA4106	138
DA2548	43	DA3002	31	DA3169	162	DA3548	43	DA4107	138
DA2565	180	DA3010	52	DA3169P	162	DA3964	134	DA4118	30
DA2602	59, 62	DA3010B	52	DA3170B	118	DA3965	134	DA4119	30
DA2603	219	DA3015	95	DA3171B	118	DA4000	215	DA4120	52
DA2603CF	219	DA3016	181	DA3173B	118	DA4000-1FK	224	DA4120N	181
DA2604	207	DA3017	181	DA3174B	118	DA4000SS	215	DA4120O	181
DA2608	221	DA3018	95	DA3175B	118	DA4001	215	DA4121	30
DA2609	221	DA3020	95	DA3176B	118	DA4001SS	215	DA4133	13
DA2610	219	DA3021	95	DA3177B	118	DA4007N	181	DA4134	13
DA2611	209, 211, 213	DA3022	95	DA3178	162	DA4007O	181	DA4136	141
DA2613	213	DA3023	95	DA3178G	162	DA4008N	180, 181	DA4136BUSH	141
DA2616	207	DA3024	95	DA3178P	162	DA4008O	180, 181	DA4136EAS	141
DA2620	10	DA3025	95	DA3179	162	DA4013N	181	DA4136FR	141
DA2652	209	DA3026	95	DA3179G	162	DA4013O	181	DA4136HD	141
DA2800BLACK	72	DA3028	106	DA3179P	162	DA4015N	181	DA4136HDFR	141
DA2800BLUE	72	DA3029	106	DA3179PG	162	DA4015O	181	DA4136HDDR	141
DA2800GREEN	72	DA3030	106	DA3180	162	DA4016N	181	DA4136RR	141
DA2800GREY	72	DA3031	106	DA3180G	162	DA4016O	181	DA4141	65
DA2800SAND	72	DA3033	106	DA3180P	162	DA4017	182	DA4142	179
DA2801BLACK	72	DA3034	106	DA3181	162	DA4018N	182	DA4143	179
DA2801BLUE	72	DA3035	226	DA3181P	162	DA4018O	182	DA4144	179
DA2801GREEN	72	DA3036	226	DA3182B	118	DA4019	179	DA4147	111
DA2801GREY	72	DA3040	226	DA3183	118	DA4020	179	DA4148	111
DA2801SAND	72	DA3041	226	DA3184	118	DA4022BLACK	70	DA4149	112
DA2802GREEN	72	DA3044	226	DA3185R	98	DA4023BLACK	70	DA4150	112
DA2802GREY	72	DA3048	226	DA3187	43	DA4023BLUE	70	DA4151	111
DA2803BLACK	73	DA3049	121	DA3188B	227	DA4023GREY	70	DA4152	111
DA2803BLUE	73	DA3049AF	121	DA3189	226	DA4025BLACK	230	DA4153	112
DA2803GREY	73	DA3049KD	121	DA3190	162	DA4025BLUE	230	DA4154	112
DA2803SAND	73	DA3050	174	DA3191	162	DA4025GREEN	230	DA4155	112
DA2804BLUE	73	DA3051	174	DA3192	162	DA4026	42	DA4156	112
DA2804GREEN	73	DA3052	174	DA3193	162	DA4027	64	DA4157	112
DA2804GREY	73	DA3054	174	DA3194	162	DA4028	80	DA4158	111
DA2804SAND	73	DA3055	174	DA3195	162	DA4029	80	DA4159	112
DA2805GREEN	73	DA3056	22	DA3196	162	DA4030	61	DA4165	111
DA2805GREY	73	DA3057	22	DA3197	162	DA4031	80	DA4169	66
DA2807BLACK	72	DA3057GLUE	22	DA3198	162	DA4032	179, 182, 184	DA4170	66
DA2807BLUE	72	DA3058	174	DA3199	162	DA4032-3SEAL	179, 182, 184	DA4171	66
DA2807GREEN	72	DA3059	81	DA3201	40	DA4032GREY	179, 182, 184	DA4172	14
DA2807GREY	72	DA3059LCS	81	DA3202	227	DA4033	179, 182, 184	DA4173	15
DA2807SAND	72	DA3059RPI	81	DA3203	128	DA4033BRONZE	179, 182, 184	DA4178	173
DA2808BLACK	72	DA3059T	81	DA3250	124	DA4033CATCH	179, 182, 184	DA4178RESISTOR	173
DA2808BLUE	72	DA3066	143	DA3251	124	DA4033GREEN	179, 182, 184	DA4179	141
DA2808GREEN	72	DA3069	95	DA3252	124	DA4033GREY	179, 182, 184	DA4180	141
DA2808GREY	72	DA3070	33	DA3253	124	DA4034	16	DA4183	66
DA2808SAND	72	DA3072	33	DA3254	124	DA4035BLUE	134	DA4185	112
DA2809BLUE	72	DA3073	30	DA3255	124	DA4036BLUE	134	DA4186	123
DA2809GREEN	72	DA3073B	30	DA3256	124	DA4041	80	DA4187	111
DA2809GREY	72	DA3077	31	DA3257	124	DA4042	80	DA4188	111
DA2810BLACK	73	DA3081	73	DA3258	124	DA4049	10	DA4189	169
DA2810GREY	73	DA3086	31	DA3259	124	DA4049B	10	DA4190	86
DA2811BLACK	73	DA3106	226	DA3260	124	DA4049S	10	DA419024V	86
DA2811GREY	73	DA3120	92	DA3262	121	DA4054	182	DA4191	88
DA2812BLUE	73	DA3121	92	DA3269	33	DA4055	80	DA4192	88
DA2812GREEN	73	DA3122	92	DA3300	112	DA4056	80	DA4193	88
DA2812GREY	73	DA3130	92	DA3301	112	DA4057	80	DA4194	86
DA2813BLACK	73	DA3135	143	DA3302	112	DA4058	92	DA4197	140
DA2813GREEN	73	DA3136	117	DA3303	112	DA4059	92	DA4198	140
DA2813GREY	73	DA3137	117	DA3304	112	DA4060	24	DA4199	140
DA2814GREY	73	DA3138	116	DA3305	112	DA4061	92	DA4201	140
DA2815BLACK	72	DA3139	116	DA3306	112	DA4062	123	DA4202	140
DA2815BLUE	72	DA3140	199	DA3307	112	DA4063	123	DA4203	140
DA2815GREEN	72	DA3141	95	DA3308	112	DA4064	123	DA4204	140
DA2815GREY	72	DA3142	95	DA3309	112	DA4065N	179, 182	DA4205	140
DA2816BLACK	72	DA3143	168	DA3310	112	DA4065O	179, 182	DA4206	140
DA2816GREY	72	DA3144	132	DA3311	112	DA4067	81	DA4208	140
DA2817GREY	72	DA3145	168	DA3312	112	DA4070	25	DA4210	135
DA2818BLACK	72	DA3147	226	DA3313	112	DA4070B	25	DA4211	135
DA2818GREY	72	DA3148	226	DA3314	112	DA4071	10	DA4221	122
DA2818SAND	72	DA3149	226	DA3315	112	DA4071B	10	DA4222	122
DA2819BLACK	73	DA3153	93	DA3316	112	DA4072	10	DA4223	122
DA2819SAND	73	DA3154	93	DA3317	112	DA4072B	10	DA4223S	124
DA2820BLACK	73	DA3155	93	DA3318	112	DA4073	10	DA4224	122
DA2821BLACK	73	DA3156	108	DA3319	112	DA4073B	10	DA4225	123
DA2822BLACK	72	DA3157E	226	DA3340	121	DA4074	10	DA4226	122
DA2822SAND	72	DA3157W	226	DA3350	208	DA4075	81	DA4227	122
DA2823BLACK	72	DA3160	107	DA3351	208	DA4075RPI	81	DA4228	122
DA2823SAND	72	DA3160A	107	DA3352	208	DA4075T	81	DA4229	122

> Part Finder

Part Number	Page Number	Part Number	Page Number	Part Number	Page Number	Part Number	Page Number	Part Number	Page Number
DA4230	123	DA4326	31	DA4485	112	DA4613	110	DA4821	71
DA4231	122	DA4327	31	DA4486	112	DA4614	110	DA4822	66
DA4232	122	DA4328	31	DA4487	112	DA4615	110	DA4823	71
DA4233	122	DA4329	31	DA4488	111	DA4616	110	DA4824	71
DA4234	122	DA4330	31	DA4493	226	DA4617	110	DA4825	66
DA4235	122	DA4331	32	DA4496	111	DA4618	110	DA4827	71
DA4236	123	DA4332	32	DA4497	120	DA4619	110	DA4828	71
DA4237	122	DA4335	112	DA4500	173	DA4622	110	DA4829	66
DA4238	122	DA4336	112	DA4501	70	DA4623	110	DA4830	112
DA4239	122	DA4337	112	DA4502	70	DA4624	110	DA4831	112
DA4240	122	DA4338	112	DA4503	67	DA4625	110	DA4832	71
DA4241	122	DA4339	112	DA4505	226	DA4626	110	DA4833	112
DA4242	123	DA4340	112	DA4507	120	DA4627	110	DA4834	112
DA4243	123	DA4341	112	DA4508	179, 180, 181	DA4628	110	DA4835	112
DA4243EXT	123	DA4342	10	DA4509	179, 180, 181	DA4629	220	DA4836	112
DA4244	122	DA4343	10	DA4511	18	DA4629B	220	DA4837	112
DA4245	123	DA4344	88	DA4512	40	DA4630	117	DA4838	112
DA4246	122	DA4348	121	DA4513	179, 180, 181	DA4631	117	DA4839	112
DA4247	123	DA4349	13	DA4514	179, 180, 181	DA4632	117	DA4840	112
DA4249	123	DA4350	92	DA4515	179, 180, 181	DA4633	117	DA4841	112
DA4250DIS	169	DA4351	92	DA4516	179, 180, 181	DA4634	117	DA4842	112
DA4251	122	DA4352	92	DA4518	179, 180, 181	DA4635	117	DA4843	112
DA4259	116	DA4353	92	DA4519	180	DA4636	226	DA4844	112
DA4260	116	DA4354	92	DA4527	179, 180, 181	DA4637	116	DA4845	112
DA4261	116	DA4355	92	DA4528	122	DA4649	84	DA4846	112
DA4262	116	DA4356	92	DA4530	180	DA4650	221	DA4847	112
DA4263	116	DA4357	92	DA4531	17	DA4654	221	DA4849	112
DA4264	116	DA4358	92	DA4532	17	DA4659	221	DA4850	112
DA4265	116	DA4359	121	DA4533	17	DA4660	221	DA4851	112
DA4266	116	DA4360	86	DA4534	17	DA4661	221	DA4852	112
DA4267	116	DA4361	86	DA4535	17	DA4663	207	DA4853	112
DA4268	116	DA4362	86	DA4536	17	DA4664	217	DA4854	112
DA4269	116	DA4363	142	DA4537	124	DA4667	121	DA4855	111
DA4270	116	DA4364	142	DA4538	121	DA4678	182	DA4856	111
DA4272	116	DA4365	142	DA4540	122	DA4679	217	DA4958	86
DA4273	117	DA4366	142	DA4545	91	DA4680	179, 182	DA4960	193
DA4274	116	DA4367	142	DA4546	91	DA4681	179, 182	DA4961	193
DA4275	117	DA4368	142	DA4546KIT	91	DA4682	179, 182	DA4962	193
DA4277	140	DA4371	124	DA4547	91	DA4683	110	DA4963	194
DA4278	140	DA4372	124	DA4548	91	DA4685	110	DA4964	194
DA4279	140	DA4373	179	DA4549	111	DA4686	110	DA4965	194
DA4284	142	DA4373S	179	DA4550	111	DA4687	110	DA4966	194
DA4284C	142	DA4374	179	DA4551	111	DA4688	110	DA4985	86
DA4285	142	DA4374S	179	DA4552	111	DA4689	110	DA5004	42
DA4285C	142	DA4375	116	DA4554	111	DA4690	110	DA5004S	42
DA4286	142	DA4376	116	DA4555	226	DA4691	220	DA5005	42
DA4286C	142	DA4376KN	117	DA4556	180, 181	DA4692	220	DA5005S	42
DA4286CHD	142	DA4377	116	DA4558	226	DA4702	34	DA5006	42
DA4286CMD	142	DA4378	116	DA4560	112	DA4703	34	DA5006S	42
DA4286HD	142	DA4379	116	DA4563	139	DA4704	34	DA5007	141
DA4286MD	142	DA4392	87	DA4564	139	DA4705	34	DA5008	141
DA4287	142	DA4395	122	DA4565	226	DA4706	34	DA5010	138
DA4287C	142	DA4396	121	DA4566	226	DA4707	34	DA5011	138
DA4288	142	DA4397	122	DA4567	118	DA4708	34	DA5012	138
DA4288C	142	DA4398	48	DA4568	118	DA4709	34	DA5014	51
DA4288CHD	142	DA4400	13	DA4569	118	DA4710	30, 34	DA5015	51
DA4288CMD	142	DA4404	16	DA4570	118	DA4711	34	DA5016	51
DA4288HD	142	DA4405	16	DA4571	118	DA4712	34	DA5016-130	51
DA4288MD	142	DA4406	16	DA4572	118	DA4713	34	DA5018	51
DA4289	142	DA4407	16	DA4573	118	DA4714	34	DA5019	51
DA4289C	142	DA4408	16	DA4574	118	DA4715	34	DA5020	51
DA4289CHD	142	DA4409	16	DA4575	118	DA4716	34	DA5021	51
DA4289CMD	142	DA4418	120	DA4577	118	DA4717	34	DA5022	30
DA4289HD	142	DA4419	120	DA4578	118	DA4718	35	DA5023	56
DA4289MD	142	DA4420	120	DA4579	118	DA4719	35	DA5024	51
DA4290	124	DA4421	120	DA4580	118	DA4720	35	DA5024-130	51
DA4291	124	DA4422	71	DA4582	118	DA4721	35	DA5025	56
DA4292	124	DA4423	71	DA4586N	180	DA4722	35	DA5026	53
DA4293	124	DA4424	71	DA4586O	180	DA4723	34	DA5027	53
DA4294	124	DA4425	71	DA4587	93	DA4724	34	DA5028	90
DA4295	124	DA4426	71	DA4588	226	DA4725	34	DA5030	61
DA4296	10	DA4427	71	DA4589	80	DA4731	34	DA5033	90
DA4297	10	DA4428	71	DA4590	80	DA4732	34	DA5034	141
DA4298	81	DA4429	71	DA4591	80	DA4733	34	DA5035	176
DA4299	142	DA4430	71	DA4592	80	DA4750	118	DA5038	176
DA4299C	142	DA4431	71	DA4593	80	DA4751	118	DA5039	176
DA4300	142	DA4433	120	DA4594	80	DA4800	71	DA5040	37
DA4300C	142	DA4434	120	DA4595	80	DA4801	71	DA5041	37
DA4301	142	DA4435	120	DA4596	80	DA4802	71	DA5042	37
DA4301C	142	DA4436	120	DA4597N	179, 182	DA4803	71	DA5043	37
DA4302	124	DA4437	120	DA4597O	179, 182	DA4804	71	DA5044	37
DA4303	124	DA4470	67	DA4598	217	DA4805	71	DA5045	37
DA4304	124	DA4472	111	DA4600	110	DA4806	71	DA5046	37
DA4305	81	DA4473	111	DA4601	110	DA4807	71	DA5047	37
DA4306	124	DA4474	111	DA4602	110	DA4808	71	DA5048	37
DA4310	238	DA4475	111	DA4603	110	DA4809	71	DA5049	37
DA4311	32	DA4476	111	DA4604	110	DA4810	21	DA5050	37
DA4312	32	DA4477	111	DA4605	110	DA4811	21	DA5051	219
DA4314	32	DA4478	112	DA4606	110	DA4812	71	DA5052	51
DA4316	30, 32	DA4479	112	DA4607	110	DA4813	71	DA5053	51
DA4317	30, 32	DA4480	112	DA4608	110	DA4814	25	DA5053-130	51
DA4319	32	DA4481	112	DA4609	110	DA4817	238	DA5054	68
DA4323	31	DA4482	112	DA4610	110	DA4818	25	DA5055	78
DA4324	31	DA4483	112	DA4611	110	DA4819	71	DA5056	78
DA4325	31	DA4484	112	DA4612	110	DA4820	71	DA5057	78

Part Number	Page Number	Part Number	Page Number	Part Number	Page Number	Part Number	Page Number	Part Number	Page Number
DA5058	78	DA5541	143	DA5717	81	DA6038	186	DA6098LR	188
DA5059LH	78	DA5550	175	DA5717W	81	DA6038COM	186	DA6098P	188
DA5059RH	78	DA5550G	175	DA5726	221	DA6038LR	186	DA6099	188
DA5060LH	78	DA5550S	175	DA5727	221	DA6038P	186	DA6099LR	188
DA5060RH	78	DA5551	175	DA5728	221	DA6039	186	DA6099P	188
DA5061	11	DA5551G	175	DA5729	221	DA6039LR	186	DA6100	179
DA5063	53	DA5551KIT	175	DA5730	221	DA6039P	186	DA6101	179
DA5065	53	DA5552	175	DA5734	221	DA6040	185	DA6102	179
DA5066	53	DA5554	66	DA5735	221	DA6040COM	185	DA6103	179
DA5067	53	DA5555	66	DA5736	221	DA6040LR	185	DA6104	179
DA5073	52	DA5556	66	DA5801A	64	DA6040P	185	DA6106	188
DA5074	52	DA5557	66	DA5803	65	DA6041	186	DA6107	22
DA5075	52	DA5558	175	DA5805	65	DA6041COM	186	DA6108	22
DA5076	90	DA5559	175	DA5806	65	DA6041LR	186	DA6109	185
DA5077	90	DA5600	93	DA5807	65	DA6041P	186	DA6109COM	185
DA5078	86	DA5601	93	DA5809	64	DA6042	164	DA6109LR	185
DA5079	78	DA5602	66	DA5810	65	DA6043	164	DA6109P	185
DA5080	78	DA5603	82	DA5811	65	DA6044	164	DA6110	224
DA5100	56	DA5603E	82	DA5812	64	DA6045	164	DA6111	201
DA5101	76	DA5604	105	DA6000	185	DA6046	164	DA6112	199
DA5102	76	DA5607	93	DA6001	185	DA6047	164	DA6113	200
DA5103	76	DA5609	105	DA6001COM	185	DA6048	188	DA6114	201
DA5104	76	DA5610	82	DA6001P	185	DA6048LR	188	DA6116	199
DA5105	76	DA5611	82	DA6002	185	DA6048P	188	DA6118	200
DA5106	76	DA5620	105	DA6002COM	185	DA6049	132	DA6119	200
DA5108	206	DA5621	105	DA6002P	185	DA6050	174	DA6120	199
DA5109	76	DA5621K	105	DA6003	185	DA6051	174	DA6121	22
DA5111	76	DA5622	105	DA6003COM	185	DA6052	174	DA6122	188
DA5112	76	DA5623	105	DA6003P	185	DA6053	174	DA6122LR	188
DA5113	76	DA5624	52	DA6004	185, 186	DA6054	174	DA6122P	188
DA5114	76	DA5625	21	DA6004COM	185, 186	DA6055	174	DA6123LR	186, 188
DA5115	76	DA5626	12	DA6004LR	185, 186	DA6056	174	DA6124	199
DA5116	76	DA5627	82	DA6004P	185, 186	DA6057	174	DA6126	202
DA5117	76	DA5627E	82	DA6004XD	185, 186	DA6058	174	DA6129	199
DA5118	76	DA5628	82	DA6005	186	DA6059	174	DA6132	202
DA5120	168	DA5628E	82	DA6005P	186	DA6060	174	DA6133	201
DA5121	168	DA5629	82	DA6006	186, 187	DA6061	174	DA6134	202
DA5121025AE	168	DA5629E	82	DA6006COM	186, 187	DA6062	174	DA6135	202
DA5121050AE	168	DA5630	82	DA6006P	186, 187	DA6063	174	DA6136	201
DA5121AE	168	DA5630E	82	DA6007	186, 187	DA6064	174	DA6200	198
DA5122	77	DA5631	202	DA6007COM	186, 187	DA6065	187	DA6201	198
DA5123	77	DA5632	82	DA6007P	186, 187	DA6065LR	187	DA6202	198
DA5124	77	DA5632E	82	DA6008	186	DA6065P	187	DA6203	198
DA5126	171	DA5633	82	DA6009	186	DA6066	187	DA6204	198
DA5127	171	DA5633E	82	DA6010	186	DA6066LR	187	DA6205	198
DA5127020	171	DA5634	82	DA6010LR	186	DA6066P	187	DA6206	198
DA5128	168	DA5634E	82	DA6010P	186	DA6067	187	DA6207	198
DA5129	168	DA5635	82	DA6011	186	DA6067LR	187	DA6208	198
DA5130	179	DA5635E	82	DA6012	186	DA6067P	187	DA6209	198
DA5131	179	DA5643	105	DA6013	186	DA6068	187	DA6210	198
DA5132	168	DA5645	105	DA6013P	186	DA6068LR	187	DA6211	198
DA5133	170	DA5646	18	DA6014	186	DA6068P	187	DA6212	198
DA5134	170	DA5647	18	DA6014LR	186	DA6070	22	DA6213	198
DA5135	139	DA5653	206	DA6014P	186	DA6071	22	DA6214	198
DA5136	141	DA5654	206	DA6015	186	DA6072	22	DA6215	198
DA5137	141	DA5655	206	DA6015COM	186	DA6073	22	DA6216	198
DA5138	76	DA5658	208	DA6015LR	186	DA6074	22	DA6217	198
DA5139	76	DA5659	208	DA6015P	186	DA6075	22	DA6218	198
DA5140	76	DA5660	208	DA6016	187	DA6076	22	DA6219	198
DA5141	76	DA5661	208, 210	DA6017	187	DA6077	22	DA6220	198
DA5142	77	DA5662	210	DA6018	187	DA6078	22	DA6221	198
DA5143	77	DA5663	213	DA6019	187	DA6079	22	DA6222	198
DA5144	77	DA5664	210	DA6020	187	DA6080	115	DA6223	198
DA5146	77	DA5667	208	DA6021	187	DA6081	115	DA6224	198
DA5147	77	DA5668	208	DA6022	187	DA6082	115	DA6225	198
DA5148	77	DA5669	210	DA6023	187	DA6084	115	DA6226	198
DA5300	177, 179	DA5670	210	DA6024	187	DA6085	188	DA6227	198
DA5495	82	DA5671	183	DA6025	187	DA6085G	188	DA6228	198
DA5496	78	DA5672	183	DA6026	187	DA6086	186, 188	DA6229	198
DA5497	78	DA5673	82	DA6027	187	DA6086COM	186, 188	DA6230	198
DA5498	78	DA5673E	82	DA6027P	187	DA6086LR	186, 188	DA6231	198
DA5499	78	DA5674	82	DA6028	187	DA6086P	186, 188	DA6232	198
DA5500	219	DA5674E	82	DA6028P	187	DA6087	186	DA6233	198
DA5501	143	DA5675	82	DA6029	187	DA6087LR	186	DA6234	198
DA5501M	143	DA5675E	82	DA6029P	187	DA6087P	186	DA6235	198
DA5502	143	DA5676	82	DA6030	187	DA6088	186, 188	DA6236	198
DA5502M	143	DA5676E	82	DA6030COM	187	DA6088LR	186, 188	DA6237	198
DA5503	143	DA5677	82	DA6030LR	187	DA6088P	186, 188	DA6238	198
DA5503M	143	DA5677E	82	DA6030P	187	DA6089	186, 188	DA6239	198
DA5504	143	DA5678	12	DA6031	187	DA6089LR	186, 188	DA6240	198
DA5504M	143	DA5679	12	DA6031LR	187	DA6089P	186, 188	DA6241	198
DA5505	129	DA5681	105	DA6031P	187	DA6091	186, 188	DA6242	198
DA5506	129	DA5684	167	DA6032	185	DA6091LR	186, 188	DA6243	198
DA5507	21	DA5699	105	DA6033	185	DA6091P	186, 188	DA6244	198
DA5507LHD	21	DA5700	90	DA6034	185	DA6093	22	DA6245	198
DA5508	21	DA5701	90	DA6035	186, 188	DA6094	22	DA6247	174
DA5509	143	DA5704	90	DA6035COM	186, 188	DA6095	188	DA6250	175
DA5510	129	DA5705	90	DA6035LR	186, 188	DA6095LR	188	DA6250G	175
DA5511A	64	DA5706	90	DA6035P	186, 188	DA6095P	188	DA6251	175
DA5513	114	DA5709	90	DA6036	188	DA6096LR	188	DA6252	88
DA5526	114	DA5710	90	DA6036LR	188	DA6096P	188	DA6253	41
DA5527	143	DA5711	90	DA6036P	188	DA6097	188	DA6254	88
DA5528	143	DA5712	90	DA6037	186, 188	DA6097LR	188	DA6259	198
DA5537	114	DA5713	90	DA6037LR	186, 188	DA6097P	188	DA6260	194
DA5539	64	DA5714	168	DA6037P	186, 188	DA6098	188	DA6261	194

Part Number	Page Number	Part Number	Page Number	Part Number	Page Number	Part Number	Page Number	Part Number	Page Number
DA6262	194	DA6392	195	DA6625	171	DA7410	164	DA8043	234
DA6263	194	DA6393	195	DA6626	171	DA7411	164	DA8044	198
DA6264	194	DA6394	195	DA6627	171	DA7412	164	DA8045	233
DA6265	194	DA6395	195	DA6628	171	DA7413	164	DA8046	233
DA6266	194	DA6396	195	DA6629	33	DA7414	164	DA8047	233
DA6267	194	DA6397	195	DA6800	204	DA7415	164	DA8048	238
DA6268	194	DA6398	195	DA6801	204	DA7416	164	DA8049	233
DA6269	194	DA6430CABLE	160	DA6802	204	DA7417	164	DA8050	233
DA6270	194	DA6436	195	DA6803	137	DA7418	164	DA8052	233
DA6271	194	DA6437	181	DA6804	137	DA7419	164	DA8053	233
DA6272	194	DA6440	174	DA6805	137	DA7420	164	DA8054	233
DA6273	194	DA6441	189	DA6806	137	DA7421	164	DA8055	233
DA6274	194	DA6447	195	DA6809	190	DA7422	164	DA8056	233
DA6275	194	DA6449	139	DA6811	122	DA7423	164	DA8059	233
DA6276	196	DA6454	198	DA6812	122	DA7424	164	DA8060	233
DA6278	198	DA6455	198	DA6813	122	DA7425	164	DA8061	233
DA6280K	51	DA6456	198	DA6814	122	DA7426	164	DA8062	233
DA6281K	51	DA6457	198	DA6815	122	DA7427	164	DA8063	233
DA6282	51	DA6458	198	DA6816	122	DA7428	164	DA8064	233
DA6283	51	DA6459	198	DA6817	122	DA7429	164	DA8065	233
DA6284	52	DA6460	198	DA6819	232	DA7430	164	DA8066	233
DA6287G	190	DA6461	198	DA6820	231	DA7431	164	DA8067	233
DA6288	192	DA6462	198	DA6821	231	DA7432	164	DA8068	233
DA6289	192	DA6463	198	DA6822	231	DA7433	164	DA8069	233
DA6290	209	DA6464	198	DA6823	41	DA7434	164	DA8070	233
DA6291	192	DA6465	198	DA6824	41	DA7435	164	DA8071	233
DA6292	192	DA6466	198	DA6825	41	DA7436	164	DA8072	233
DA6293	193	DA6467	198	DA6826	232	DA7437	164	DA8073	233
DA6294	193	DA6468	198	DA6827	232	DA7438	164	DA8074	233
DA6295	52	DA6469	198	DA6828	232	DA7439	164	DA8075	233
DA6296	190	DA6470	198	DA6829	232	DA7440	164	DA8076	222
DA6300	198	DA6471	198	DA6830	232	DA7441	164	DA8077	233
DA6301	198	DA6472	198	DA6831	232	DA7442	164	DA8078	233
DA6304	198	DA6473	198	DA6832	232	DA7443	164	DA8079	233
DA6305	198	DA6474	198	DA6833	232	DA7446	164	DA8080	233
DA6306	198	DA6475	198	DA6834	232	DA7460	201	DA8081	233
DA6307	198	DA6476	198	DA6835	232	DA7461	202	DA8082	234
DA6309	198	DA6477	198	DA6836	87	DA7463	202	DA8083	222
DA6310	198	DA6478	198	DA6837	87	DA7464	202	DA8084	222
DA6311	198	DA6479	198	DA6839	232	DA7465	202	DA8085	222
DA6313	198	DA6480	198	DA6840	232	DA7466	202	DA8086	222
DA6314	198	DA6481	198	DA6841	139	DA7480	217	DA8087	222
DA6316	198	DA6482	198	DA6842	41	DA7481	217	DA8088	222
DA6317	198	DA6483	198	DA6844	232	DA7530	21	DA8089	222
DA6319	198	DA6484	195	DA6892	215	DA7530B	21	DA8090	222
DA6322	130	DA6485	193	DA6893	215	DA7531	131	DA8091	222
DA6322L	130	DA6486	193	DA6894	215	DA7532	21	DA8092	222
DA6323	130	DA6493	220	DA6895	215	DA7533	26	DA8093	222
DA6323L	130	DA6496	193	DA7011	24	DA7534	19	DA8094	222
DA6323XD	135	DA6497	195	DA7011SS	24	DA7534B	19	DA8095	222
DA6324	130	DA6498	195	DA7012	24	DA7535	21	DA8096	222
DA6326	198	DA6500	91	DA7012SS	24	DA7535B	21	DA8097	222
DA6327	198	DA6502	48	DA7200	130	DA7536	21	DA8530	50
DA6328	198	DA6503	48	DA7201	130	DA7537	105	DA8531	50
DA6337	130	DA6504	218	DA7202	130	DA7538	105	DA8532	50
DA6338	131	DA6505	218	DA7203	130	DA7602	208, 210	DA8533	229
DA6339	143	DA6506	218	DA7204	130	DA7610	208, 210, 213	DA8534	26
DA633925	143	DA6507	164	DA7205	130	DA7611	208, 210, 213	DA8890	172
DA6341	131	DA6508	164	DA7206	130	DA7999	238	DA8891	172
DA6342	131	DA6509	164	DA7207	130	DA8000	234	DA8893	211, 212, 213
DA6343	42	DA6516	181	DA7208	130	DA8002	234	DA8894	172
DA6344	131	DA6520	183	DA7211	176	DA8003	234	DA8895	172
DA6345	131	DA6529	33	DA7212	130	DA8003X	234	DA8896	172
DA6348	189	DA6537	33	DA7300	171	DA8004	234	DA8897	132
DA6350	143	DA6538	21	DA7301	83	DA8005	233	DA8899	132
DA6351	143	DA6539	21	DA7302	83	DA8006	233	DA8900	177
DA6352	143	DA6540	21	DA7303	83	DA8007	233	DA8902N	180
DA6353	143	DA6541	108	DA7304	83	DA8008	233	DA8902O	180
DA6354	143	DA6545	231	DA7305	83	DA8009	233	DA8903	180
DA6355	143	DA6546	231	DA7306	83	DA8010	233	DA8904	108
DA6356	143	DA6547	231	DA7307	83	DA8011	233	DA8906	177
DA6358	193	DA6548	44	DA7308	83	DA8012	233	DA8907	177
DA6364	198	DA6549	44	DA7310	83	DA8013	233	DA8910	139
DA6365	198	DA6550L	16	DA7311	83	DA8014	234	DA8911	137
DA6366	198	DA6550R	16	DA7313	83	DA8015	234	DA8912	139
DA6367	181	DA6551	215	DA7314	83	DA8016	234	DA8913	137
DA6368	192	DA6554	217	DA7315	83	DA8017	234	DA8914	139
DA6369	192	DA6555	217	DA7316	83	DA8018	233	DA8915	139
DA6370	195	DA6600	219	DA7317	83	DA8019	233	DA8916	137
DA6371	195	DA6601	230	DA7330	229	DA8020	233	DA8917	137
DA6372	192	DA6602	230	DA7331	229	DA8021	233	DA8918	139
DA6373	192	DA6604	196	DA7332	229	DA8023PACK	238	DA8919	139
DA6374	192	DA6605	196	DA7333	229	DA8024	234	DA8920	139
DA6375	192	DA6606	196	DA7334	229	DA8025	234	DA8921	137
DA6376	192	DA6607	196	DA7335	107	DA8027	234	DA8922	139
DA6377	192	DA6608	196	DA7400	164	DA8028	233	DA8923	139
DA6378	192	DA6609	196	DA7401	164	DA8029	233	DA8924	139
DA6379	192	DA6610	18	DA7402	164	DA8036	234	DA8925	143
DA6380	192	DA6611	18	DA7403	164	DA8037	234	DA8926	88
DA6381	192	DA6613	18	DA7404	164	DA8038	234	DA8927	41
DA6382	195	DA6620	171	DA7405	164	DA8039	238	DA8928	91
DA6384	195	DA6621	171	DA7406	164	DA8040	233	DA8929	232
DA6386	195	DA6622	171	DA7407	164	DA8041	233	DA8930	41
DA6390	195	DA6623	171	DA7408	164	DA8042	234	DA8931	41
DA6391	195	DA6624	171	DA7409	164	DA8042PACK	238	DA8932	91

Part Number	Page Number	Part Number	Page Number	Part Number	Page Number	Part Number	Page Number	Part Number	Page Number
DA8933	231	DB1310GALV	104	DC7001	133	ETC5835K	167	LBCH223NVA	236
DA8934	88	DB1310R	104	DC7002	133	EXTERIOR STICKER	238	LBCH224BNA	236
DA8935	219	DB1310RGALV	104	DC7003	133	FENDER	227	LBCH224NVA	236
DA8936	219	DB1313	104	DC7004	133	FENDER HARBOUR	227	LCJ000050LKIT	168
DA8937	219	DB1313-24V	104	DC7005	133	FENDER RESCUE	227	LD500180COM	168
DA8938	219	DB1313GALV	104	DC7006	133	FJL101530PMA	78	LDKR925IVA	236
DA8943	219	DB1313R	104	DC7007	133	FJL101680PMA	78	LDKR928BKA	236
DA8944	219	DB1313RGALV	104	DC7008	133	FJL101710PMA	78	LOGOBOARD	238
DA8945	219	DB1314	108	DC7009	133	FRC3602X	189	LPF500020	171
DA8946	219	DB1315	106	DC7010	133	FRC3875	163	LPX100590XD	169
DA8947	219	DB1316	106	DC7011	133	FRC4142SS	162	LR000470G	166
DA8948	219	DB1317	106	DC7012	132	FRC7329G	166	LR001018G	166
DA8949	219	DB1318	108	DC7013	132	FS108207LX	189	LR001019G	166
DA8950	219	DB1319	104	DC7100	133	FS108257LX	189	LR002408	15
DA8951	132	DB1319R	104	DC7101	133	FS108307LX	189	LR002417	32
DA8952	132	DB1320	104	DC7102	133	FTC1381G	166	LR002424	67
DA8953	219	DB1320R	104	DC7103	133	FTC1507	163	LR002464	213
DA8954	219	DB1321	104	DC7104	133	FTC2957HD	175	LR002485	70
DA8956	87	DB1321R	104	DC7105	133	FTC2957HDKIT	175	LR002497	70
DA8958	221	DB1322	107	DC7106	133	FTC3846G	166	LR002516	67
DA8959	86	DB1323	107	DC7107	133	FTC4746BUSH	176	LR002521	64
DA8960	86	DB1324	104	DC7108	133	FTC4746KIT	176	LR002525	213
DA8961	86	DB1324R	104	DC7109	133	FTC5200HD	175	LR002626HD	129
DA8963	119	DB1325	104	DC7110	133	FTC902G	166	LR002748	192
DA8964	119	DB1325R	104	DC7111	133	FWJ500020PMA	76	LR002773	25
DA8965	119	DB1327	103	DC7112	132	HAD501820RPI	80	LR002876HD	129
DA8966	119	DB1328	103, 108	DC7113	132	HAD501850LOY	80	LR003156	192
DA8967	119	DB1328H	103	DC8000	135	HAD501870LOY	80	LR003156G	190
DA8968	119	DB1329	107	DC8001	135	HAD501870RPI	80	LR003318	25
DA8969	119	DB1330	103	DEFENDER STICKER	238	HAG100970LOY	80	LR003319	11
DA8970P	119	DB1331	103	DGJ500020PCL	20	HAH103510LOY	80	LR003322	17
DA8971	119	DB1332	103	DHH100780LQV	214	HAI101400LOY	80	LR003324	165
DA8972	119	DB1334	103	DHH100790LQV	214	HAI101410LOY	80	LR003657	17
DA8973	119	DB1336	103	DKC500010PMD	238	HBA106180LOY	80	LR003657G	165
DA8974	119	DB1337	103	DLB101770M	167	HBA106190LOY	80	LR003685	15
DA8981	232	DB1338	103	DPB000270	12	HBD000320JMN	73	LR003894	68
DA8987	87	DB1339	103, 108	DPB000270GALV	12	HBD000320LUP	73	LR003905 206, 208, 210,	213
DA8988	87	DB1340	103	DPB104270S	12	HBD000320LYR	73	LR004404S	169
DA8989	87	DB1341	103, 106	DPT100070	216	HBD000320SUN	73	LR004799G	170
DA8990	212	DB1343	103	EAH000261PMA	70	HCA106010LOY	80	LR004936	165
DA8991	212	DB1344	104	EAH000271PMA	70	HGA500500	80	LR004936DT	113
DA8994	87	DB1344R	104	EAH000300JMN	70	HH102280	80, 82	LR004936G	165
DA8995	107	DB1345	104	EAH000300PVA	70	HH102290	80, 82	LR005039	70
DA8998	41	DB1345R	104	EAH000300SUN	70	IAB500104E	176	LR005040	67
DA8999	214	DB1346	104	EAH000310JMN	70	INTERIOR STICKER	238	LR005041	71
DA9001	89	DB1346R	104	EAH000310LUP	70	ISG000040	18	LR005058	73
DA9002	89	DB1347	104	EAH500011LUP	70	ISG000050	18	LR005059	73
DA9003	89	DB1347R	104	EAH500011PVJ	70	IYK500010	192	LR005613	67
DA9004	89	DB1348	104	EAH500015SMS	70	IYK500010-20L	192	LR005615	67
DA9006	89	DB1348R	104	EAH500050PMA	70	IYK500010G	190	LR005648PY	132
DA9009	89	DB1349	104	EAH500051PMA	70	JAK000065MMM	210	LR005649PY	132
DA9009B	89	DB1349R	104	EAH500052PMA	70	JAK500320WWH	208	LR005919	57
DA9011	89	DB1350	104	EAH500057PMA	70	JAK500330WWH	208	LR005920	57
DA9012	229	DB1350R	104	EAH500058PMA	70	JEF100150	173	LR005921	57
DA9013	229	DB1352	103	EAH500080PVJ	70	JEF100220	173	LR006237	70
DA9015	125	DB1352R	103	EAH500100PMA	70	JFC102550B	51	LR006238	70
DA9016	125	DB1353	107	EAH500290LUP	70	JKR500020X	168	LR006247G	190
DA9017	125	DB1354	103, 108	EAH500290PVA	70	JLR-303-1619	201	LR006304	208
DA9018	125	DB1355	103	EAH500290SUN	70	JQD500080V	173	LR006401	68
DAG500160	214	DB1355R	103	EAH500320PMA	70	KAH000050	93	LR006433	70
DB1000	108	DB1356	103	EAH500330PMA	70	KBM100450	42	LR006437	70
DB1001	108	DB1500	99	EAH500520	67	KBM100460	42	LR006848	32
DB1002	107	DB2000	103	EAH500530	67	KBM100470	42	LR006849	32
DB1003	106	DB6000	102	EAH500540	67	KBM100480	42	LR007055G	166
DB1004	106	DB9000C	102	EBF000040	68	KBM100490	42	LR007205-6BJ	163
DB1005	106	DB9000CR	102	EBF500010	68	KBM100500	42	LR007221	57
DB1006	106	DB9500i	101	EBF500020	68	KBM100510	42	LR007222	57
DB1007	106	DB9500i24	101	EBN500040	209	KBM100520	42	LR007223	57
DB1008	107	DB9500iR	101	EBN500041	211	KBM100530	42	LR007320	65
DB1009	107	DC5000	136	EGP1889PY	133	KBM100540	42	LR007484	58, 61
DB1010	108	DC5000L	136	ERC2886W	121	KBP10001	42	LR007484G	58, 61
DB1011	106	DC5001	136	ERC4536K	167	KNB100640	56	LR008361	214
DB1012	107	DC5001L	136	ERR3340X	168	KNB500070	58, 61	LR008375	24
DB1014	101, 102, 108	DC5002	136	ERR4686BLUE	172	KNK500060	60	LR008375B	24
DB1015	108	DC5002L	136	ERR4686RED	172	KNK500070	60	LR008375SS	24
DB1016	108	DC5003	136	ERR5027COM	168	KNK500080	60	LR008379	24
DB1017	108	DC5003L	136	ERR6299X	168	KNW500020	58, 61	LR008379B	24
DB1017P	108	DC5004	136, 143	ESR158SS	123	KVB000290	179	LR008379SS	24
DB1018	98	DC5005	136, 143	ESR2297SS	123	KVB500060	179	LR008556	175
DB1019	98	DC6000	136	ESR2381SS	123	KVB500230	179	LR008713	209, 211
DB1020	98	DC6000L	136	ESR2383SS	123	KVD500710	177	LR008913	50
DB1021	98	DC6000LL	136	ESR2391S	124	KVD500710HD	177	LR008975	50
DB12000i	101	DC6001	136	ESR2740	121	KVD500710-M	177	LR008982	50
DB12000i24	101	DC6001L	136	ESR3195SS	123	KVD500730	177	LR009711	50
DB12000iR	101	DC6001LL	136	ESR3495SS	123	KVD500730HD	177	LR009792	50
DB1300	103	DC6002	136	ESR3538SS	123	KVL100040	26	LR010368	50
DB1301	103	DC6003	136	ESR358SS	123	LACH015BLA	236	LR010673	162
DB1302	103	DC6004	136, 143	ESR4238X	168	LACH015GMA	236	LR010674	162
DB1303	103	DC6005	136, 143	ESR4526SS	123	LACH015RDA	236	LR011870	42
DB1304	103	DC6006	136, 143	ESR4686X	168	LAKR272SLA	236	LR011870HD	42
DB1307	103, 106	DC6007	136	ESR54SS	123	LANDY	227	LR012199	175
DB1308	108	DC6009	136, 143	EST110075/76KIT	175	LANDY FACTORY	227	LR012199C	175
DB1308-24V	108	DC6010	136	ETC4291/2/3/4	168	LANDY HARVEST	227	LR012199P	175
DB1309	108	DC6011	136	ETC5835EBLACK	167	LANDY NEW HOME	227	LR013164	170
DB1310	104	DC7000	133	ETC5835ERED	167	LBCH113NVA	236	LR014145HD	129

Part Number	Page Number	Part Number	Page Number	Part Number	Page Number	Part Number	Page Number	Part Number	Page Number
LR014147	163	LR030213	98	LR061388G	166	LTP3016USB	228	NRC7842SS	123
LR015089	134	LR031526	179	LR064181	165	LTP3017	228	NRC8888SS	123
LR015303	134	LR031665G	137	LR064181G	165	LTP3017USB	228	NRC8889SS	123
LR015519	165	LR031667G	137	LR068126B	43	MRC2178X	189	NRC9137SS	123
LR015519DT	113	LR031790	18	LR070497G	58	MRC316	13	NRC9700GALV	130, 131
LR015519G	165	LR031812	18	LR071295	58, 61	MRC316P	13	NRC9836SS	123
LR016176G	166	LR031843G	166	LR072258G	191	MRC3519	79	NTC1149SS	123
LR016192G	166	LR031844G	166	LR072537	134	MRC6980	81	NTC1150SS	123
LR017770	69	LR031845G	166	LR072681	165	MRC6980CB	81	NTC1322SS	123
LR017951G	166	LR031846G	166	LR072681G	165	MRC6980CG	81	NTC1665SS	123
LR017952G	166	LR031924	93	LR072855	98	MRC6982	81	NTC1666SS	123
LR017953G	166	LR031947KIT	164	LR072972	175	MRC6982CB	81	NTC1772PY	133
LR018026G	166	LR032305	212	LR073366HD	129, 132	MRC6982CG	81	NTC1772PY-YELLOW	133
LR019618	165	LR032306	212	LR073366PF	134	MRC6982H	81	NTC1773PY	133
LR019618DT	113	LR032903	165	LR073366PY	132	MRC6985	81	NTC1773PY-YELLOW	133
LR019618G	165	LR032903DT	113	LR073367GK	129	MRC6985CB	81	NTC1775PY	133
LR019627	165	LR032903G	165	LR073367K	129	MRC6985CG	81	NTC1775PY-YELLOW	133
LR019627DT	113	LR032954	165	LR073369GK	129	MRC7166	181	NTC1800SS	123
LR019627G	165	LR032954G	165	LR073369K	129	MTC2640A	220	NTC2726SS	123
LR019727	192	LR033179	98	LR073537	176	MTC3181	81	NTC2832SS	123
LR019727LR	190	LR033302G	166	LR073538	176	MTC3181CB	81	NTC4221SS	123
LR019979K	129	LR033303G	166	LR073539	176	MTC3181CG	81	NTC4426SS	123
LR019980K	129	LR036574	165	LR075993GK	129	MTC5083	16	NTC4614SS	123
LR020362	165	LR036574G	165	LR075993HD	129	MTC5084	16	NTC5193PM	43
LR020362G	165	LR038128	98	LR075993K	129	MTC5217	16	NTC6781PY	133
LR021253	165	LR038341	98	LR075993NB	129	MTC5382	182	NTC6781PY-YELLOW	133
LR021253DT	113	LR038617	214	LR075994HD	129	MTC5382G	182	NTC6791SS	123
LR021253G	165	LR038934G	166	LR075995GK	129	MTC5383	182	NTC6828PY	133
LR021316	165	LR039149	174	LR075995HD	129	MTC5383G	182	NTC6828PY-YELLOW	133
LR021316DT	113	LR039935G	166	LR075995K	129	MTC8294	67	NTC6860PY	133
LR021316G	165	LR041041	58, 61	LR075995NB	129	MTC9967	80	NTC6860PY-YELLOW	133
LR021899	165	LR041041G	58, 61	LR075996HD	129	MTC9968S	219	NTC7307PY	133
LR021899G	165	LR043285	165	LR078650	134	MUC1488	81	NTC7307PY-YELLOW	133
LR023391BLK	44	LR043285DT	113	LR079910	165	MUC1520	81	NTC7394PY	133
LR023573	137	LR043285G	165	LR079910G	165	MUC1520G	81	NTC7394PY-YELLOW	133
LR023580	137	LR043714	165	LR079935	165	MUC2344	17	NTC7829	42
LR023888	165	LR043714DT	113	LR079935G	165	MUC2437	79	NTC7829HD	42
LR023888G	165	LR043714G	165	LR083935	165	MUC3990	17	NTC8780G	166
LR023889	190	LR044034	134	LR083935G	165	MUC4122ABE	79	NTC9820	138
LR023964	134	LR045096	70	LR089424LR	46	MUC7916AG	79	NY606041X	189
LR023964G	134	LR045097	70	LR094642	98	MWC1010	80	NZ606041X	189
LR024474HD	129	LR045409X	189	LRAVENTUREBEAR	235	MWC1743	84	PDA500300	190
LR024835G	190	LR045519REPAIRKT	170	LRCEAHUEG	235	MWC3136X	189	PDA500310	190
LR025111	134	LR047798LED	50	LRCORPMUG14	235	MWC3302	80	PEB102240LG	170
LR025739	165	LR048187LED	50	LRDCA3EVOQ	235	MWC3303	80	PEB102420LG	170
LR025739G	165	LR048187LEDCL	50	LRDCA4005	235	MWC4535	80	PEB500090G	170
LR025862	44	LR048188LED	50	LRDCA494	235	MWC4840	180	PEM500040G	170
LR025862MNH	44	LR048189LED	50	LRDCA494G	235	MWC4841	180	PHD500340	94
LR025946G	166	LR048200LED	50	LRDCA5EVOQ	235	MWC5628LCS	80	POSTER SET	238
LR026221	165	LR048200LEDCL	50	LRDCADISCO	235	MWC5670LCS	80	PRC2949	181
LR026221DT	113	LR048201LED	50	LRCONMUG14	235	MWC6702	180	PRC7994C	50
LR026221G	165	LR048201LEDCL	50	LRKRALLK	236	MWC6754	180	PRC7994K	50
LR026592	212	LR048202LED	50	LRKRALLS	236	MWC9060	180	PRC8238	48
LR026593	212	LR051311	176	LRKRANHUE	236	MWC9061	180	PRC8876LED	50
LR026595	212	LR051320	176	LRL0087ENG	226	MWC9084	180	PSD103470BRG	175
LR026596	212	LR051585PF	134	LRL0178ENG	226	MWC9085	180	PYP10008BLUE	172
LR027107G	166	LR051585PY	132	LRUGNIP	235	MWC9843LCS	80	PYP10008RED	172
LR027123G	166	LR051586HD	129, 132	LRSPABACBP	235	MWC9844LCS	80	QFK500010HD	129
LR027129	165	LR051586PF	134	LRSPANGL	235	MXC1800X	189	QFK500020HD	129
LR027129G	165	LR051586PY	132	LRSPANGS	235	MXC1992LCS	84	RBJ102920/930BJ	163
LR027309	165	LR051621PY	132	LRSPANNL	235	MXC2063	181	RBJ102920/930BJG	163
LR027309DT	113	LR051622GK	129	LRSPANNS	235	MXC2064	181	RBJ500222GK	129
LR027309G	165	LR051623GK	129	LRSPANRRSL	235	MXC3257LCS	80	RBJ500232GK	129
LR027664	40	LR051626	165	LRSS12RCCW	235	MXC3918	181	RBJ500680/690BJ	163
LR027666	40	LR051626DT	113	LRSS12RHW	235	MXC3919	181	RBJ500680/690BJG	163
LR028245GK	129	LR051626G	165	LRT-12-058	199	MXC5587	17	RBJ500840NB	129
LR028245HD	129	LR051771	214	LRT-12-093	200	MXC6402	214	RBJ500850NB	129
LR028245K	129	LR052028	18	LRT-12-094	200	MXC6412	17	RBL0526SSS	30, 36
LR028245NB	129	LR052756	176	LRT-12-158	199	MXC6413	17	RBL10875SS	36
LR028246HD	129	LR053845	43	LRT-60-003	199	MXC8335	181	RBL13835SS	36
LR028249GK	129	LR054831PY	132	LRT-60-004	202	NACH295ORA	236	RBL13875SS	36
LR028249HD	129	LR055323	17	LRT-64-003	199	NAD10040HD	119	RBL1506SSS	36
LR028249K	129	LR055330	17	LRTOAHT30UK	235	NAD101490HD	119	RBL1506SSS	36
LR028249NB	129	LR055331	17	LRTMAGBR	236	NGC103740/810	167	RBL150FFK	36
LR028250HD	129	LR055332	17	LRUNIJACMUG14	235	NGC103740/810RED	167	RBL1727PAD	36
LR029294KIT	24	LR055333	17	LTP3001	228	NGC500370/410	167	RBL1727SSS	36
LR029295/7KIT	24	LR055334	17	LTP3001USB	228	NGH605041X	189	RBL1857SSS	36
LR029301HD	129	LR055339	17	LTP3002	228	NRC2051	56	RBL18875SS	36
LR029302HD	129	LR055340	17	LTP3002USB	228	NRC236	182	RBL19075SS	36
LR029303GK	129	LR055454	165	LTP3003	228	NRC236E	182	RBL2057SSS	36
LR029303HD	129	LR055454DT	113	LTP3003USB	228	NRC4171GALV	178, 179	RBL21375SS	36
LR029303K	129	LR055454G	165	LTP3004	228	NRC4218SS	123	RBL2303SSS	36
LR029304GK	129	LR055455	165	LTP3004USB	228	NRC4219SS	123	RBL2303SSSBLACK	36
LR029304HD	129	LR055455DT	113	LTP3005	228	NRC4356	177	RBL23675SS	36
LR029304K	129	LR055455G	165	LTP3005USB	228	NRC4514PY	133	RBL2427SSS	36
LR029304NB	129	LR056964PY	132	LTP3006	228	NRC4514PY-YELLOW	133	RBL2437SSS	36
LR029305GK	129	LR059122G	166	LTP3006USB	228	NRC4642G	177	RBL2447SSS	36
LR029305HD	129	LR059125	214	LTP3007	228	NRC4717	181	RBM100172HD	129
LR029305K	129	LR059126	214	LTP3007USB	228	NRC5593PY	133	RBM100223HD	129
LR029306GK	129	LR059127	214	LTP3008	228	NRC5593PY-YELLOW	133	RBM500190HD	129
LR029306HD	129	LR059128	214	LTP3008USB	228	NRC6372GALV	130	RBM500200HD	129
LR029306K	129	LR059129	214	LTP3010	228	NRC6432SS	123	RBX000571PY	132
LR029306NB	129	LR061295LR	58	LTP3015	228	NRC6433SS	123	RBX101240PY	133
LR030047HD	129	LR061385	165	LTP3015USB	228	NRC6436SS	123	RBX101240YELLOW	133
LR030048HD	129	LR061385G	165	LTP3016	228	NRC6920	94	RBX101340YELLOW	133

Part Number	Page Number	Part Number	Page Number	Part Number	Page Number	Part Number	Page Number	Part Number	Page Number
RBX101680PY	133	RTC4236	135	SFP500190	165	STC4863	192	STC8604	179
RBX101680YELLOW	133	RTC4483B	137	SFP500190G	165	STC4863G	190	STC8605	179
RBX101690PY	133	RTC4484	135	SFP500200	165	STC50026	14	STC8606	179
RBX101690YELLOW	133	RTC4484B	137	SFP500200G	165	STC50027	14	STC8607	179
RBX101730PY	133	RTC4517CL	181	SFP500210	165	STC50032	26	STC8608	179
RBX101730YELLOW	133	RTC4615C	50	SFP500210G	165	STC50050	68	STC8609	179
RBX101780PY	133	RTC4615CW	50	SFS500012KIT	164	STC50052AA	68	STC8610	179
RBX101780YELLOW	133	RTC4615K	50	SIJ500030	190	STC50053AA	68	STC8648	179
RBX101790PY	133	RTC4615KW	50	SIJ500040	190	STC50063	30	STC8649	179
RBX101790YELLOW	133	RTC4615W	50	STC1066	180	STC50064	14	STC8652	179
RBX500301PY	132	RTC4639B	137	STC1135	181	STC50080	42	STC8653	179
RBX500311PF	134	RTC4685	17	STC1136	181	STC50081	59	STC8693	179
RBX500311PY	132	RTC4769	12	STC1172B	168	STC50134	30	STC8694	179
RDB100080PY	133	RTC5225HD	119	STC1184K	167	STC50172	70	STC8695	179
RDB100080YELLOW	133	RTC5232HD	119	STC1188	50	STC50181	59	STC8843AA	42
REB101740	138	RTC6204	181	STC1424	179	STC50221	17	STC8875	59
RGD000312HD	129	RTC6247	179, 182	STC1601	165	STC50222	17	STC8919AA	59, 62
RGD100682HD	129	RTC6248	179, 182	STC1601G	165	STC50243	52	STC8972	189
RGD500140HD	129	RTC6248NG	179, 182	STC1694/5/6/7	168	STC50269AA	25	STC9021CC	226
RGD500150HD	129	RTC6317	181	STC1774VT	190	STC50287AB	58	STC9049CA	226
RGX100960K	132	RTC6318	181	STC2015	166	STC50289AB	58	STC9124	167
RGX100970PY	133	RTC6350	179	STC250	173	STC50290	26	STC9155	190
RGX100970YELLOW	133	RTC6351	179	STC2802B	168	STC50301	25	STC9157	190
RGX101000PY	133	RTC6352	179	STC2813	180	STC50319	58	STC9158	190
RGX101000YELLOW	133	RTC6401VA	190	STC2814	180	STC50323	64	STC9189	165
RGX101010PY	133	RTC6551	167	STC2815	180	STC50389	59	STC9189G	165
RGX101010YELLOW	133	RTC6551RED	167	STC2816	180	STC50391	60	STC9190	165
RGX101020PY	133	RTC6732/3/4/5	168	STC2828VT	190	STC50413	11	STC9190G	165
RGX101020YELLOW	133	RTC6820	17	STC2830B	137	STC50417	30	TAG000230CWP	174
RGX101440PY	133	RTC6821	17	STC2862A	190	STC50434	67	TAY100050L	163
RGX101440YELLOW	133	RTC6870VT	190	STC2864VT	190	STC50435	67	TAY100060L	163
RGX500060PY	132	RTC8095	64	STC2952	165	STC50459	60	TRAYBACK STICKER	238
RGX500101PY	132	RTC8831	56	STC2952G	165	STC50460	60	TRC102900	174
RGX500111PY	132	RTC8860AA	13	STC3018SS	52	STC50479	64	TRC103150	174
RGX500121PY	132	RTC8872	56	STC3135	173	STC50519	193	TRC103160E	174
RGX500290PY	132	RTC8891AA	57, 58, 60	STC3261	173	STC50519-20L	193	TRC103350E	174
RGX500300PY	132	RTC8922	48	STC3410	42	STC50519LR	190	TYK500010	192
RKB101200	138	RTC8969	13	STC3411	42	STC50529	190	TYK500010-20L	192
RKB101460	138	RTC9479	17	STC3412	42	STC50530	190	TYK500010G	190
RNF100090PY	133	RTC9503AA	14	STC3413	42	STC50531	192	TYK500030	192
RNF100090YELLOW	133	RTC9535	42	STC3414	42	STC50531LR	190	TYK500050	192
ROA000022PY	132	RTC9562	17	STC3415	42	STC50543	190	TYK500050-20L	192
ROA100040PY	133	RTC9840CC	226	STC3416	42	STC50544	190	TYK500050-4L	192
ROA100050PY	133	RTC9841CE	226	STC3417	42	STC50550	190, 198	TYK500050G	190
RPM100070B	137	RTC9842CE	226	STC3418	42	STC50551	190	TYL100030	189
RPM100080B	137	RTC9846CH	226	STC3419	42	STC50552	198	UMAGBG	236
RRB100370	42	RTC9863CE	226	STC3420	42	STC53075AA	17	URB500060	175
RRB100510	42	RTC9947CF	226	STC3421	42	STC53076AA	17	URB500060B	175
RRB500100	42	RTC9970CE	226	STC3422	42	STC53157	13	UTP1725	173
RRC2970	18	SDB000201G	166	STC3423	42	STC53158	13	VPLAB0025LML	208, 210
RRC2971	18	SDB000211G	166	STC3424	42	STC53161	13	VPLAP0008	14
RRC501470MCM	44	SDB000330G	166	STC3425	42	STC53181	14	VPLAP0009	14
RRC503400MNH	44	SDB000380G	166	STC3426	42	STC53193	14	VPLAP0017	17
RRC503600PM	43	SDB000470G	166	STC3427	42	STC53194	14	VPLAP0022	11
RRC505360MNH	44	SDB000604G	166	STC3428	42	STC542	179	VPLAP0035	26
RRC505370MNH	44	SDB000614G	166	STC3429	42	STC543	179	VPLAR0001	32
RRC6681	12	SDB000624G	166	STC3435	189	STC60713	214	VPLAR0164LR	30
RRC6682	12	SDB000636G	166	STC3435S	189	STC618PY	133	VPLAS0015	68
RRC8443	16	SDB000646G	166	STC3580	42	STC618PY-YELLOW	133	VPLAS0023PVJ	70
RRD000011	46	SDB100830G	166	STC3581	42	STC637G	170	VPLAS0130PVJ	73
RRD000100	42	SDB101070G	166	STC3582	42	STC7555	64	VPLAS0197	70
RRD000110	42	SDB500182G	166	STC3583	42	STC7582	32	VPLAS0198	70
RRD000120	42	SDB500193G	166	STC3584	42	STC7623LR	42	VPLAT0011	59
RRD000130	42	SDB500202G	166	STC3585	42	STC7631	25	VPLCP0203	17
RRD100520	42	SE105161L	50	STC3586	42	STC7631MT	25	VPLCP0204	17
RRD100530	42	SERVICE KIT LEAFLET	238	STC3587	42	STC7632	25	VPLCP0205LR	17
RRD100540	42	SERVICE STICKER	188	STC3588	42	STC7632MT	25	VPLCP0209LR	26
RRD100550	42	SFC500080	165	STC3589	42	STC7639	31	VPLCP0210LR	26
RRD100560	42	SFC500080G	165	STC3601	42	STC7643	48	VPLCS0268LR	68
RRD100570	42	SFP000250	165	STC3671B	137	STC7644	48	VPLCS0269	69
RRD100580	42	SFP000250G	165	STC3672B	137	STC7703	17	VPLCS0271	69
RRD100590	42	SFP000260	165	STC3703B	137	STC7889	42	VPLCS0273LR	68
RRD100600	42	SFP000260G	165	STC3704B	137	STC793/4/5/6	168	VPLCS0274LR	68
RRD100610	42	SFP000270	165	STC3758G	170	STC7939AB	64	VPLCS0278LR	70
RRD500510	46	SFP000270G	165	STC3766B	137	STC7978AB	17	VPLCS0279LR	68
RRD500510B	43	SFP000280	165	STC3767B	137	STC8027LR	15	VPLCS0280LR	70
RRD500510G	46	SFP000280G	165	STC3769B	137	STC8056LR	13	VPLCS0281LR	70
RRD500560	46	SFP100360	165	STC3770B	137	STC8057AC	32	VPLCS0291PVJ	73
RRD500560B	43	SFP100360G	165	STC3771B	137	STC8130AB	26, 27	VPLCS0291PVJLR	73
RRJ000030	42	SFP500010	165	STC3772B	137	STC8138AB	91	VPLCS0291SVALR	73
RRJ100120	42	SFP500010DT	113	STC3939B	137	STC8156AA	128	VPLCS0292PVJLR	73
RRY500180SS	162	SFP500010G	165	STC4235VT	190	STC8156AAPY	128	VPLCS0292SVALR	73
RSC100040B	137	SFP5000070	165	STC4286	57, 59	STC83354	179	VPLCS0293PVJLR	73
RSC100050B	137	SFP500070DT	113	STC4378G	170	STC83355	179	VPLCS0293SVALR	73
RTC3095	90	SFP500070G	165	STC4404	189	STC83356	179	VPLCS0300	64
RTC3254	189	SFP500120	165	STC4596VT	190	STC83358	175	VPLCT0140LR	58
RTC3347	189	SFP500120G	165	STC4600	189	STC83363	175	VPLCT0142	58
RTC3534	163	SFP500130	165	STC4637	50	STC8414	64	VPLCT0143	58
RTC3534G	163	SFP500130G	165	STC4672	190	STC8480LR	48	VPLCT0147	58
RTC3537	163	SFP500150	165	STC4676	190	STC8505AA	27	VPLCT0148	58
RTC3537G	163	SFP500150G	165	STC4757	190	STC8524	65	VPLCT0182	59
RTC3633LED	50	SFP500160	165	STC483G	98	STC8529AA	91	VPLCT0244	59
RTC3840A	119	SFP500160G	165	STC4861	190	STC8535	17	VPLDP0067	24
RTC4234	135	SFP500180	165	STC4862	192	STC8536	17	VPLDP0068	24
RTC4235	135	SFP500180G	165	STC4862G	190	STC8587	98	VPLDR0063	32

> Part Finder / Index

Part Number	Page Number	Part Number	Page Number	Part Number	Page Number	Part Number	Page Number	Part Number	Page Number
VPLDR0064	32	VPLGT0073	62	VPLVP0066	17	VUB001230	27	XBD100770W	51
VPLDR0130	40	VPLGT0082	61	VPLVP0069	17	VUB001300	27	XBD500010LED	50
VPLDS0011	73	VPLHT0061	62	VPLVP0070	17	VUB001310	27	XBD500040LED	50
VPLDS0147	70	VPLHT0062	62	VPLVP0071	27	VUB001320	17	XBD500050LED	50
VPLDT0086	57	VPLMS0085PVJ	73	VPLVP0184	27	VUB001330	17	XDISC	114
VPLDV0001	214	VPLMS0085SVA	73	VPLVS0070PVJ	73	VUB002120	65	XFC100550CH	216, 224
VPLDV0003	214	VPLMS0087PVJ	73	VPLVS0071PVJ	73	VUB002510	27	XFC100550LEDG	50
VPLDW0095PVT	43	VPLMS0087SVA	73	VPLVS0072PVJ	73	VUB500510LR	64	XFD100100LED	50
VPLFR0091	30, 31	VPLMS0302	69	VPLVS0073PVJ	73	VUB500520	14	XFD100100LEDCL	50
VPLFS0107PVJ	73	VPLPP0060	11	VPLVS0077PVJ	73	VUB500900	238	XFD500010	50
VPLFS0233	70	VPLPP0061	11	VPLVS0089	68	VUB501170	64	XFD500010LED	50
VPLFS0234	70	VPLRP0269LR	26	VPLVS0090	68	VUB501200	14	XFD500040LED	50
VPLFS0244	67	VPLRP0270LR	26	VPLVS0091	68	VUB501380	14	XFD500040LEDCL	50
VPLFS0245PVJ	70	VPLRP0282LR	17	VPLVS0102	69	VUB501390	15	XFD500050LED	50
VPLFS0246PVJ	70	VPLRP0283LR	17	VPLVS0125	69	VUB501920	15	XFD500050LEDCL	50
VPLFT0001	60	VPLRS0332AAMLR	70	VPLVT0065	61	VUB501930	15	XFE500010	50
VPLFT0077	60	VPLRS0332PVJLR	70	VPLVT0069	61	VUB501980	11	XFE500010LED	50
VPLFT0105	60	VPLRS0333AAMLR	70	VPLVT0078	61	VUB502130	32	XFE500010LEDCL	50
VPLFT0106	60	VPLRS0333PVJLR	70	VPLWP0165	17	VUB503650	206	XGB100310L	216
VPLFT0118	60	VPLRS0335PVJLR	73	VPLWP0166	17	VUB503660	27	XPAD	114
VPLFT0119	60	VPLRS0386LR	73	VPLWP0167	17	VUB503760	11	XQB500080	48
VPLFT0120	60	VPLRS0373AAMLR	68	VPLWS0228PVJ	73	VUB503880MMM	206, 208, 210, 213	YGD000271	98
VPLGP0100	27	VPLRS0373PVJLR	68	VPLWS0228SVA	73	VUB503940	17	YGD100860	98
VPLGP0109	17	VPLRS0386LR	68	VPLWS0229PVJ	73	VUB503960	61	YGD500100	98
VPLGP0110	17	VPLRT0171LR	58	VPLWS0229SVA	73	VUB503960	61	YGD500130	98
VPLGP0111	17	VPLRT0175LR	58	VPLWS0230PVJ	73	VUB504110	13	YMZ101030	60
VPLGP0226	27	VPLSP0010	15	VPLWS0230SVA	73	VUH000020	62	YW0000840	62
VPLGP0238LR	27	VPLSP0016	17	VPLWT0114	62	VUP100140L	231	YWJ101500	57
VPLGP0239LR	27	VPLSP0040	27	VPLWT0159	61	VYK000010	190	YWJ500070	60
VPLGP0248LR	27	VPLSS0016	68	VTD500010	26	WCE000030SS	123	YWJ500150	62
VPLGP0249LR	27	VPLSS0026PVJ	73	VTD500020	26	WCE000040SS	123	YWJ500201	59
VPLGS0151	68	VPLSS0042	209	VTK500010	26	WCE104231SS	123	YWJ500450	62
VPLGS0153	69	VPLSS0043	68	VTK500020	27	WDE100590SS	123	YWJ500460	62
VPLGS0154PVJ	73	VPLSS0104	70	VUB000720	61	WDV100260SS	123	YWT10002L	59, 60, 62
VPLGS0154SVA	73	VPLSS0138	69	VUB000730	61	WDV100270SS	123		
VPLGS0155PVJ	73	VPLST0014	62	VUB000740	61	WDV500020SS	123		
VPLGS0155SVA	73	VPLTP0064	15	VUB001070LR	15	XBD100670LED	50		
VPLGS0263	68	VPLVP0065	17	VUB001080LR	15	XBD100760W	51		

A-Bars	11	Brake calliper pistons	166	Chassis	177
AdBlue diesel exhaust fluid	191	Brake cleaner	189, 193	Chassis components	179 - 182
Adjustable ball joint	131	Brake discs	110 - 111	Chequer plate	10
Adjustable suspension lift rod kit	93	Brake discs, EBC	111	Clear lights	51
Air compressors, diff lockers	86 - 87	Brake discs, XS	166	Clothing	233
Air compressors, tyres	40 - 41	Brake fitting kit	164	Clutch alignment tool	200
Air conditioning fans	119	Brake fluid	190	Clutch pedal assist kit	174
Air filters, K&N	117	Brake hoses	113	Clutch reservoir tanks	164, 176
Air filters, performance	116 - 117	Brake kits	164	Clutch tools	200
Air Lift	138	Brake lubrication	166	Clutches	175
Air spring conversion kits	141	Brake pads, DTEC	113	Comfort connectors	98
Air springs	138	Brake pads, EBC	111 - 112	Compressors	86 - 87
Air suspension compressors	134	Brake pads, XD	165	Compressors, air suspension	134
Air tank	87	Brake pads, XS	165	Con rod components	171
Alloy wheels	44	Brake pipe bending tool	164	Connecting spindle rods	129
Alternator	119	Brake pipe sets	164	Cool bag	231
Alternator upgrades	167	Brake pipe swivel mount bracket	178	Coolant hoses	118
Aluminium header tanks	118	Brake reservoir tanks	164, 176	Coolants	190, 193
Anti-freeze	190	Brake tools	201	Cooling system pressure test kit	202
Anti-rattle jack clamps	93	Bridging ladders	93	Corbeau seats	83
Anti-roll bars	128	Britpart clothing	233	Coupling control unit	176
Anti-squeal shims	164	Britpart Expedition roof racks	33	Covers, spare wheel	42
ARB diff lockers	88	Bulbs	51	Crankshaft tools	201
Armrests	76 - 77	Bulk filters	168	Crossmembers	179 - 182
Ashcroft Transmissions	89	Bulkhead	179 - 182	Crown wheel & pinion	174
Auto transmission lever parts	176	Bulkhead bars	77	Crown wheel & pinions, heavy-duty	89
Automatic torque biasing differentials	89	Bulkhead front assembly	183	Cruise control system	217
Automatic transmission fluid change kits	188	Bump stops	132	Cubby boxes	76 - 77
Awnings	232	Bumper fitting kits	12	Cup holder	76
Ball joint	131	Bumper, bodywork	183	CV joints	174
Ball joint repair kits	163	Bumper, LED	49	CV joints, heavy-duty	89
Batteries	98	Bumperettes	12, 18	Cylinder head overhaul kits	171
Battery charger	98	Bumpers	12, 18	Cylinder heads	168
Battery isolator switch	108	Bumpers, winch	104 - 105	Cylinder liner kit	168
Battery management system	99	Bungee Clic load securing kit	37	Damper kit	173
Bearing grease	189	Bush fitting tools	202	Dash camera	11
Bearings, propshaft	174	Bushes	128, 132 - 134, 137	Daytime lights	49
Bike racks	30 - 32	Calibration tools	199	Deflectors, wind	22
Bilstein shock absorbers	137	Camera kits, reversing	18	Demister kit	220
Black wheel nuts	43	Camera, dash	11	Detent repair springclip	174
Blanking kits	115 - 116	Camera, rear surround	18	Detroit lockers	90
Bleed screws	172	Camping equipment	231 - 232	Die-cast models	237
Blind spot mirror	16	Carburettors, Weber	62	Diesel injector sockets	202
Blindo wheels	45	Cargo barriers	64 - 65	Diesel system cleaner	193
Body components	179 - 182	Cargo tie down point	69	Diff coupling shaft	173
Body repair consumables	196	Carpet mats	70	Diff cover	88
Boge, shock absorbers	137	Castor corrected swivel housings	128	Diff guard	21
Bolt kits	224	Castor correction bushes	132	Diff lock lever	90
Bolts	163	Castor correction wedges	139	Diff lockers	86 - 90
Bonnet hinges	216	Castrol Classic oils	194	Diff overhaul kits	176
Books	227	Cellular Dynamic shock absorbers	136	Diff rebuild kit	176
Boot protection	66 - 69	Cera-Tec lubricant	110	Diff repair pans	173
Bottle jack	93	Chain cover	84	Dinitrol products	197
Bowler lightweight wheels	45	Chair, camping	232	Dirt D-fenders	16

Dislocation cones	131	Headlamp bulbs	51	Meyle bushes	129
Distributor merchandise	238	Headlamp protectors	13	Meyle heavy-duty	129
Dog guards	64 - 65	Headlamps	50	Mirrors	16
Door card fixing kit	84	Heated mirror kit	16	Model engine	238
Door handle covers	206, 208	Heated seats	81	Models	237
Door hinges	183	Heated windscreen	218	Mont Blanc roof bars	32
Door lock button	183	Heater blower motor kit	173	Mudflap brackets	17
Door stays	84	Heater control light upgrade	51	Mudflaps	17
Doors	179 - 182	Heater matrixes	173	NAS lights	50
Double cardan repair kit	176	Heater plug upgrade kit	169	Number plate mounting bracket	105
Double S exhausts	122 - 123	Heavy-duty drive flanges	128	Nuts & bolts, tamper proof	12
Downpipes	121	Heavy-duty shock absorbers	135	Oil analysis kit	193
Dr. Tranny Instant Shudder Fixx	190	Heavy-duty steering arms	143	Oil cooler repair kit	169
Drive flanges	128	Hi-Lift jacks	92	Oil filler cap	172
Driving lights	48	Hinge guards	230	Oil filter tools	200
DTEC brake pads	113	Hinges	183	Oil pump	171
Dual battery management system	99	Hood sticks	79	Oil pump gear set	169
Dust caps	40	Hoods	79	Old Man Emu shock absorbers	137
Dynaline shackle	107	Hub assembly	163	Old Man Emu springs	139
Dynalite alternator	119	Hylomar consumables	189	Optima batteries	98
Dynamat Xtreme	222	iCarsoft multi-system scanner	160	Original technical publications	228
Dynamic response tools	201	Ignition conversion kits	167	Overdrive units	125
EAS override module	141	Ignition lead sets	167	Paint pens	198
EBC brake discs	111	Ignition module	167	Panhard rods	128
EBC brake pads	111 - 112	Injector pipe sets	168	Parabolic springs	138
EGR blanking kits	115 - 116	Injector washers	169	Parking brake springs	164
Electric windows	217	Inner tubes	40	Parking sensors	18
Electronic distributors	167	Inspection lamps	53	Parts catalogues	226
Electronic fan conversion kits	119	Intercooler hoses	118	Performance air filters	116 - 117
Emergency equipment	90 - 91	Intercoolers, performance	117	Performance brake discs	110 - 111
Emergency hammer	91	Interior festoon bulbs	50	Piston ring set	171
Engine bay enhancements	172	Interior lamp	217	Pistons	170
Engine oils	190, 192	Interior roof consoles	220	Polybush sets	132
Engines	169	Interior trim	84	Polyurethane bushes	133
Enhancements	206 - 222	IRD repair kit	174	Portable PowerPacks	94
Exhaust clamps	123	Isolator switch	108	Power steering fluid	193
Exhaust fitting kit	122	Isopon repair consumables	196	Power steering reservoir cap	172
Exhausts components	123	Jack base	93	Powerflex bushes	134
Exhausts, stainless steel	121 - 124	Jack clamps	93	Powerlite starter motors	119
Expansion bottle cap	172	Jackall jacks	92	PowerPacks	94
Extended fuel tanks	91	Jacks	92 - 93	Pressure relief valve	169
Extended seat rails	77	Jerry cans	91	Programmable wiper relay	167
Exterior lights	48, 52	Jubilee clips	189	Prop shaft fastener tools	201
Fairleads	106	Ladders	30, 31, 34, 36	Propshaft bearings	174
Fan conversion kits	119	Land meters	93	Propshaft spacers	143
Fasteners	189	Land Rover merchandise	235 - 236	Propshafts	143
FBH controller	208, 210	Land Rover roof racks	32	Protection, rear	18
Filler plugs	172	Landy books	227	PSI Tuning	120
Filter guards	115	Leaf spring castor correction wedges	139	Pulleys	107
Filters, bulk	168	Leaf springs	138	Puncture repair kit	40 - 41
Fire extinguishers	91	LED bumper	49	Radiator hose kit	171
First aid kits	90	LED headlamps	51	Radiator muffs	230
Floor mats	70 - 71	LED interior festoon bulbs	50	Radius arms	129
Fog lights	48	LED light bars	52	Raised air intakes	94 - 95
Fridges/freezers	231	LED lights	50	Raptor	195
Front bumpers	12	Lift rod kit	131	Ratchet straps	69
Front Runner roof racks	31	Lifted springs	140	Ravenol Classic oils	194
Fuel burning heater	208, 210	Light bars	52	Ravenol consumables	192 - 193
Fuel cooler guard	21	Light conversions	49 - 51	Rear diff & carrier	176
Fuel filter holder	169	Light guards	13 - 15	Rear protection	18
Fuel latch repair	184	Light kits	49	Rear silencers	124
Fuel tank fitting kit	184	Light mountings	52	Rear steps	25 - 26
Fuel tank guards	21	Light upgrades	49 - 51	Rear surround cameras	18
Fuel tanks, extended	91	Lighting, workshop	203	Recovery kits	91
Fulcrum brackets	128	Lights, driving	48	Remote reservoir shock absorbers	135
Fume curtain	79	Lights, fog	48	Replacement headlamps	50
Fuse box screws	219	Lights, LED	50	Retention kits	69
Gaiter kits	22	Lights, spot	48	Re-trim kits	82
Gaiters	78	Link assembly anti-roll bars	129	Reversing camera kits	18
Galvanised products	178	Load securing system	37	Revotec electric fans	119
Galvanised roof racks	31	Load straps	69	Richards chassis	177
Gasket sets	168	Loadspace mats	67 - 69	Roamerdrive	125
Gear box gaiters	78	Loadspace nets	69	Rock sliders	19
Gear change kits	174	Locking fuel cap	229	Rockers	170
Gear lever knobs	219	Locking wheel nuts	42	Roll cages	36
Gearbox bearings	174	Loctite consumables	198	Roller fairleads	106
Gearboxes	174	Long range fuel tanks	91	Roof bars	31 - 32
Glove boxes	77	Lowered springs	139	Roof boxes	32
GPS tracking	229	Lynx Evo diagnostics interface	146	Roof console	220
Grab handles	219	Lynx Eye LED headlamps	51	Roof rack ladders	30
Grease	193	Lynx replacement parts	160	Roof racks	31 - 34
Grease nipples	189	Mach 5 wheels	45	Roo-Lites	49
Ground anchors	93	Mag books	227	Ropes	106
Guards, dog	64 - 65	Main bearing sets	168, 171	Rubber mats	67 - 69, 70 - 71
Guards, light	13 - 15	Manifold assembly fuel sensor	171	Rubbing strips	20
Half-shafts	89	Manifold inlet seal	169	Safety Devices roll cages	36
Handbooks	226	Manifold link	171	Safety Devices roof racks	34
Handbrake conversion	114	Marsland chassis	177	Sand ladders	93
Hawse fairleads	106	Mats	67 - 69	Screw kits	224
Haynes manuals	226	MaxXtrac wheels	45	Seat belt stress plate	78
Head bolt sets	168	Merchandise	233 - 238	Seat belts	78
Header tanks, aluminium	118	Metallik paste	196	Seat covers	72 - 73

Seat handle	82	Steering wheels	221	USB charger	217
Seat heater kits	81	Steps, rear	25 - 26	Utility link pipes	124
Seat rails	77	Steps, side	24 - 26	Valve caps	40
Seat re-trim kits	82	Strops	106	Valve unit	173
Seats	80 - 83	Stub axle kits	162	Vehicle enhancements	206 - 222
Seats, Corbeau	83	Sump guard/plates	21	Vent hinge pins	216
Seats, Sparco	83	Super Gaz, shock absorbers	136	Vent knobs	219
Seats, XS style	82	Suspension arms	129	Voltmeter gauge	217
Security box	76	Suspension ball joint repair kits	163	Waffle boards	93
Security equipment	229 - 230	Suspension bolt kits	163	Water pumps	170
Security marking kit	229	Suspension bolts	130	Water sensor repair kit	170
Service kits	185 - 188	Suspension kits	142	Waterproof seat covers	72 - 73
Service sticker	188	Suspension mounts	179 - 182	Watts linkage bush	132
Shackles	107	Swivel housing gaiter kits	22	Weber carburettors	121
Shelter/shade	232	Swivel housing grease	189	Wet clutch oil	191
Shims, anti-squeal	164	Swivel housing kits	162	Wheel adaptors	42
Shock absorber brackets	130	Swivel housings, castor corrected	128	Wheel arch kits	20
Shock absorber turrets	130, 135	Swivel oil seal retainers	162	Wheel bearings	163
Shock absorbers	135 - 137	Swivel pin kits	162	Wheel carriers	40
Short oil filter	169	Swivel pin/mudshield bracket	178	Wheel chocks	108
Side protection	19 - 20	Tailgate chain cover	84	Wheel hub assemblies	163
Side protectors	24	Tailgate conversion trim kit	209	Wheel nuts	43
Side steps	24 - 26	Tailgate half door	183	Wheel protection	42
Silicone hoses	115, 118	Tailgate hinge brackets	183	Wheel spacers	42
Silicone sleeves, universal joint	21	Tamper proof nuts & bolts	229	Wheel valve caps	40
Skytag	229	Td5 oil pump	171	Wheel wrenches	42
Slings	106	TdV6 engine parts	171	Wheels	43 - 45
Snatch block	107	Technical publications	228	Wide angle propshafts	143
Snorkels	94 - 95	Techno style seats	80	Winch accessories	106 - 108
Snow cowls	215	Tents	232	Winch accessory kits	108
Sockets	200	Thule roof bars	31	Winch bumpers	104 - 105
Sound deadening	222	Timing belts	169	Winch remote control	108
Space saver wheels	40	Timing chain kit	169	Winch ropes	106
Spacer blocks	131	Timing tools	199	Winch safety equipment	108
Spanners	200	Tools	199 - 204	Winch shackles	107
Sparco seats	83	Top hat liner set	169	Winch spare parts	103
Spare light bulbs	51	Touch up paint pens	198	Winches	100 - 103
Spare wheel carriers	40	Towing equipment	56 - 62	Wind breaks	232
Spare wheel covers	42	Trade tack stab	189	Wind deflectors	22
Spare wheel strap	40	Transfer boxes	176	Windows	179 - 182, 184
Speedo Healer	43	Transmission filter conversion kits	173	Windscreen wiper motors	167
Split charge relay	99	Transmission flush & fill	204	Wing mirrors	16
Spot lights	48	Transmission guards	21	Wings	179 - 182
Spring kit, parking brake	164	Transmission oils	190, 192 - 193	Wiper blades	238
Spring retainers	131	Transmission service kits	173	Wiper relay	167
Spring seats	131	Travel kits	90	Work lights	52
Spring spacer blocks	131	Tree sliders	19	Workshop fasteners	189
Springs, air	138	Trim removal tool kit	202	Workshop fluids	190 - 191
Springs, coil	139 - 141	Trim, dash	84	Workshop manuals	226
Springs, leaf	138	Trim, door	84	X-Column	229
Springs, lifted	140	Truetrac lockers	90	XD brake pads	165
Springs, lowered	139	T-shirts	233	XD handling kit	139
Springs, Old Man Emu	139	Tuning products	120 - 121	XD oil	191
Springs, parabolic	138	Turbo Boost Box	121	XD remote reservoir shock absorbers	135
Stabiliser link bars	129	Turbo hoses	118	X-Defend pedal lock	230
Stainless steel exhausts	121 - 124	Turret rings	131	Xenon headlamp bulbs	51
Stainless steel fixings	224	Tyre inflators	86	XS brake discs	166
Starter motors	119	Tyre maintenance	41	XS brake pads	165
Starting handle	238	Tyre pressure monitoring	40	XS style seats	82
Steel wheels	43	Tyre repair kit	40 - 41	XS water pumps	170
Steering arms	143	Unbreakable mirrors	21 - 22	X-Trouser	220
Steering box repair kit	162	Underside protection	21 - 22	Zu wheels	46
Steering dampers	136, 143	Universal joint silicone sleeves	21		
Steering rack ball joint repair kits	162	Upgrade chips	120		



Photo courtesy of Mikhail Badun

United Kingdom Registration Years

Suffix letter series 1963 - 1983

Letter	From	To
A	1st January 1963	31st December 1963
B	1st January 1964	31st December 1964
C	1st January 1965	31st December 1965
D	1st January 1966	31st December 1966
E	1st January 1967	31st July 1967
F	1st August 1967	31st July 1968
G	1st August 1968	31st July 1969
H	1st August 1969	31st July 1970
J	1st August 1970	31st July 1971
K	1st August 1971	31st July 1972
L	1st August 1972	31st July 1973
M	1st August 1973	31st July 1974
N	1st August 1974	31st July 1975
P	1st August 1975	31st July 1976
R	1st August 1976	31st July 1977
S	1st August 1977	31st July 1978
T	1st August 1978	31st July 1979
V	1st August 1979	31st July 1980
W	1st August 1980	31st July 1981
X	1st August 1981	31st July 1982
Y	1st August 1982	31st July 1983

Prefix letter series 1983 - 2001

Letter	From	To
A	1st August 1983	31st July 1984
B	1st August 1984	31st July 1985
C	1st August 1985	31st July 1986
D	1st August 1986	31st July 1987
E	1st August 1987	31st July 1988
F	1st August 1988	31st July 1989
G	1st August 1989	31st July 1990
H	1st August 1990	31st July 1991
J	1st August 1991	31st July 1992
K	1st August 1992	31st July 1993
L	1st August 1993	31st July 1994
M	1st August 1994	31st July 1995
N	1st August 1995	31st July 1996
P	1st August 1996	31st July 1997
R	1st August 1997	31st July 1998
S	1st August 1998	28th February 1999
T	1st March 1999	31st August 1999
V	1st September 1999	29th February 2000
W	1st March 2000	31st August 2000
X	1st September 2000	28th February 2001
Y	1st March 2001	31st August 2001

New style series 2001 - onwards

Year	1st March to 31st August	1st September to 28th February
2001/2002	N/A	51
2002/2003	02	52
2003/2004	03	53
2004/2005	04	54
2005/2006	05	55
2006/2007	06	56
2007/2008	07	57
2008/2009	08	58
2009/2010	09	59
2010/2011	10	60
2011/2012	11	61
2012/2013	12	62
2013/2014	13	63
2014/2015	14	64
2015/2016	15	65
2016/2017	16	66
2017/2018	17	67

Get All The Latest Britpart News

We have two easy ways to keep in touch with all the latest news and product releases.

1. Newsletter

Simply log on to www.britpart.com and register your details in the 'Mailing List' section or simply send an e-mail with newsletter in the subject field to - marketing@britpart.co.uk

2. Facebook

Go to www.facebook.com/britpart and click the 'like' button to see all the latest product releases when they happen - no need to wait for the next catalogue release.

Make Your Land Rover A Star

If you have a great picture of your Land Rover and would like to see it featured in the next Britpart catalogue, then please send it to marketing@britpart.co.uk with all your details. We look forward to seeing them and each one sent in will automatically be entered into the next Britpart calendar competition. See www.britpart.com/calendar for more details on the competition. Happy snapping!

The Small Print

- > Britpart is a wholesaler only.
To purchase parts and for technical questions, contact your local stockist.
To find yours go to www.britpart.com/distributors
- > Part numbers used for identification purposes only and do not imply or indicate the identity of a manufacturer.
- > Genuine Land Rover parts and accessories are for sale in EU countries only.
- > Parts are subject to stock and supply.
- > Pictures are for reference only and specifications may alter without notice.
- > Colour swatches are for reference only - samples are available on request.
- > All products available at time of printing and we reserve the right to withdraw any product at any time.
- > Land Rover logos and trade names are for reference only.
- > No part of this catalogue may be used or reproduced by any means without the express permission of Britpart.
- > Product specifications are given but it is up to the end user to ensure that the product is fit for that purpose.
- > E&OE

BRITPART

The quality parts for Land Rovers

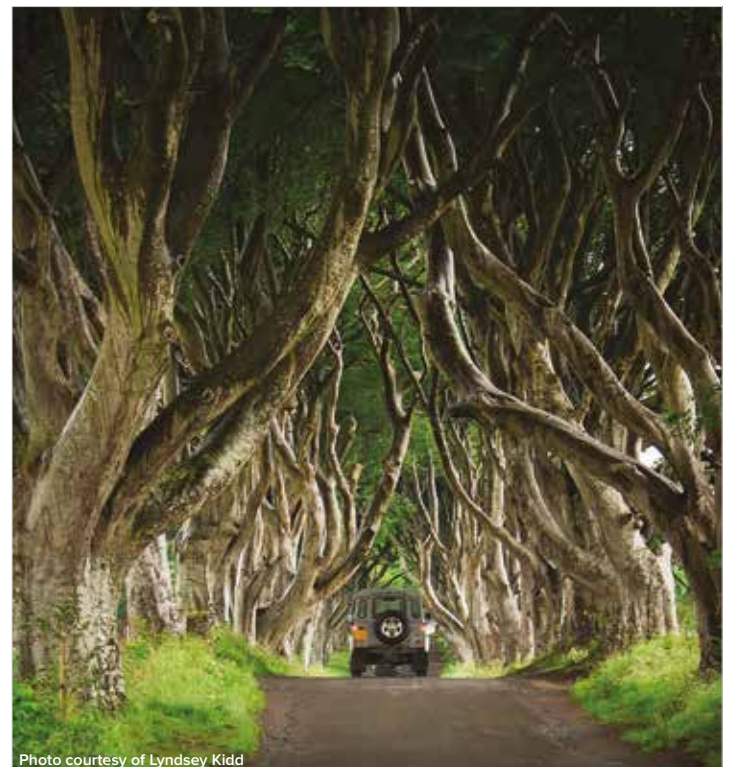

Photo courtesy of Lyndsey Kidd

North Eastern 4x4 is committed to providing the highest quality service to Land Rover owners. Established in 2007 by two IMI Level 4 Master technicians, Warren Portues & Chris Ferguson, North Eastern 4x4 has a dedicated team of specialist and trustworthy fully trained technicians who can help with all your Land Rover needs – at a fraction of the price of main dealers.

We specialise in:

- > Servicing
- > Diagnostics
- > Parts
- > Accessories

We are ATA accredited, which means that we have the stamp of approval from the Automotive Technician Accreditation (ATA).



North Eastern 4x4

Ross Road
Portrack Lane
Stockton-On-Tees
TS18 2NH

01642 606001

info@northeastern4x4.co.uk

Opening Hours

Mon - Fri - 8:30 - 17:30
Sat - 8:30 - 12:30

www.northeastern4x4.co.uk